

WheatNet-IP BLADE 3

AUDIO OVER IP NETWORK

TECHNICAL MANUAL



WheatNet-IP BLADE 3

AUDIO OVER IP NETWORK

TECHNICAL
MANUAL

Wheatstone Corporation
Jan 2016



Wheatstone WheatNet-IP BLADE3 Audio Over IP Network - 2nd Edition

Navigator GUI version 3.7.X and higher

©2018 Wheatstone Corporation

 *Wheatstone Corporation*

600 Industrial Drive
New Bern, North Carolina 28562
tel 252-638-7000 / fax 252-637-1285

Attention!

Federal Communications Commission (FCC) Compliance Notice: Radio Frequency Notice

NOTE: This equipment has been tested and found to comply with the limits for a Class A digital device, pursuant to Part 15 of the FCC rules. These limits are designed to provide reasonable protection against harmful interference when the equipment is operated in a commercial environment. This equipment generates, uses, and can radiate radio frequency energy and, if not installed and used in accordance with the instruction manual, may cause harmful interference to radio communications. Operation of this equipment in a residential area is likely to cause harmful interference in which case the user will be required to correct the interference at his own expense.



This is a Class A product. In a domestic environment, this product may cause radio interference, in which case, the user may be required to take appropriate measures.

This equipment must be installed and wired properly in order to assure compliance with FCC regulations.

Caution! Any modifications not expressly approved in writing by Wheatstone could void the user's authority to operate this equipment.



Attention!

WheatNet-IP Blade3s

Important Safety Instructions

1. Read these instructions.
2. Keep these instructions.
3. Heed all warnings.
4. Follow all instructions.
5. This equipment must be installed and operated in a dry location free from dripping or splashing liquids. No objects filled with liquid (such as beverage containers and the like) shall be placed on or near the unit.
6. Clean only with dry cloth.
7. Do not block any ventilation openings. Install in accordance with the manufacturer's instructions.
8. Do not install near any heat sources such as radiators, heat registers, stoves, or other apparatus (including amplifiers) that produce heat.
9. Do not defeat the safety purpose of the polarized or grounding-type plug. A polarized plug has two blades with one wider than the other. A grounding type plug has two blades and a third grounding prong. The wide blade or the third prong are provided for your safety. If the provided plug does not fit into your outlet, consult an electrician for replacement of the obsolete outlet.
10. Protect the power cord from being walked on or pinched particularly at plugs, convenience receptacles, and the point where they exit from the apparatus.
11. Only use attachments/accessories specified by the manufacturer.
12. Unplug this apparatus during lightning storms or when unused for long periods of time.
13. Refer all servicing to qualified service personnel. Servicing is required when the apparatus has been damaged in any way, such as power-supply cord or plug is damaged, liquid has been spilled or objects have fallen into an apparatus, the apparatus has been exposed to rain or moisture, does not operate normally, or has been dropped.
14. DISCONNECTING DEVICE FROM MAINS – Main power cord plug is the disconnecting device. The power plug of an installed unit must remain readily accessible/operable at all times.



WARNING!

To reduce the risk of fire or electric shock, do not expose this apparatus to rain or moisture.



Attention!

WheatNet-IP Blade3s

Consignes De Sécurité Importantes

1. Lire ces instructions.
2. Conserver ces instructions.
3. Observer tous les avertissements.
4. Suivre toutes les instructions.
5. Ce matériel doit être installé et utilisé dans un endroit sec à l'abri d'éclaboussures de liquides ou de gouttes. Aucun objet rempli de liquides tel que breuvages ou autres, ne doit être placé sur le dessus ou à côté de cet appareil.
6. Nettoyer uniquement avec un linge sec.
7. Ne pas bloquer les ouvertures de ventilation. Installer d'après les instructions du fabricant.
8. Ne pas installer près de sources de chaleur tels que des radiateurs, registres de chaleur, poêles ou autres appareils (incluant les amplificateurs) pouvant de la chaleur.
9. Ne pas contourner le dispositif de sécurité de la fiche polarisée ou de mise à la terre. Une fiche polarisée a deux lames dont une plus large que l'autre. Une fiche de terre a deux lames et une troisième broche de mise à la terre. La lame large ou la troisième broche est fournie pour votre sécurité. Si la fiche fournie ne rentre pas dans votre prise, consultez un électricien pour le remplacement de la prise obsolète.
10. Protéger le cordon d'alimentation en évitant qu'il ne soit piétiné ou écrasé notamment au niveau des fiches et le point de sortie de l'appareil.
11. N'utiliser que les fixations et accessoires spécifiés par le fabricant.
12. Débrancher cet appareil pendant les orages ou lorsqu'il n'est pas utilisé pendant de longues périodes de temps.
13. Confier toute réparation à un personnel qualifié. Une réparation est nécessaire lorsque l'appareil a été endommagé de quelque façon que ce, soit tel que : le cordon d'alimentation ou la fiche est endommagée, du liquide a été renversé ou des objets sont tombés dans l'appareil ou celui-ci a été exposé à la pluie ou à l'humidité ou ne fonctionne pas normalement ou s'il est tombé.
14. DÉBRANCHEMENT DE L'APPAREIL DU SECTEUR – Le cordon d'alimentation principal est le dispositif de déconnexion. Le cordon d'alimentation d'une unité installée doit rester facilement accessible / utilisable à tout moment.



ATTENTION!

Pour réduire le risque d'incendie ou de choc électrique, ne pas exposer cet appareil à la pluie ou à l'humidité.



WheatNet-IP BLADE3 Quick Start Setup Guide

Before Getting Started

The purpose of this document is to aid in the quick setup of your new Wheatstone WheatNet-IP product. The WheatNet-IP product comes with a setup mode that will walk you through the setup process. This setup mode is designed to help you get the system up and running quickly with little effort. If you have any issues during the setup process please contact Wheatstone Technical Support for further assistance at (252) 638-7000.

The guide assumes that connectivity will take place by one of the following methods.

Isolated Network

It is recommended that connectivity of the WheatNet-IP be made through an isolated Gigabit Ethernet switch.

House Network



Careful planning should be done if the WheatNet-IP system will integrate into your house network. A separate VLAN or other isolation method must be deployed to contain the multicast traffic. This guide assumes the network is equipped with a Gigabit network switch or router capable of handling this type of configuration. Consult your IT department for more information.

Front Panel Dual OLED's

BLADE 3s come with dual OLED displays for monitoring and control of most functions right from the front panel, including audio routing setup, monitoring, network information, alarm status, enabling and operating utility mixes, setting input and output gain, and connecting audio processing. Settings can also be done remotely using a PC.



The front panel's two OLED displays, two buttons, and the knob quickly and easily allow you to set up and configure each BLADE 3 unit.

Rotation of the knob navigates up and down a menu when there is a list, or scrolls thru options in a submenu once one has been selected. Pressing the right arrow button navigates through sub-menu options. Pushing the right arrow button or the knob is “takes” an option. The  button backs out of a submenu to the main menu. 

Use of the controls will become clearer as we go through some examples.

BLADE 3 Setup Mode

As shipped from the factory, each BLADE 3 will initially start up in **Blade Setup** mode.

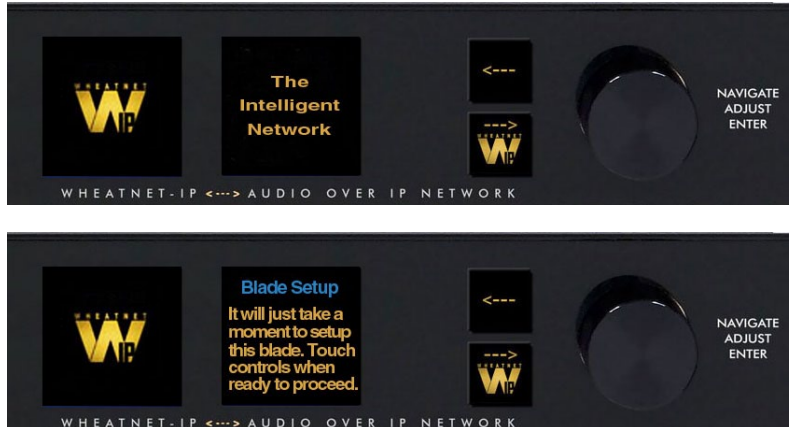

Activating any of the front panel controls will begin the setup process, during which you will be faced with a small number of choices, as indicated on the right side OLED display.

Your first decision involves “System Size” and is something that should be well thought out before doing **Blade Setup** on your first BLADE 3. Here are the three choices, and their significance:

- **1-99 Blades** – This would be your choice for a small to medium sized system. When you choose this size the setup wizard will automatically assign network settings to the BLADE 3 based on your choice of Blade ID (see below). IP addresses will be assigned within the 192.168.87.xxx subnet, with the last octet being assigned a value of 100 plus the Blade ID. The subnet mask will be set to 255.255.255.0, and the gateway will be set to 192.168.87.1. Once you have gone through the complete **Blade Setup** process you will be able to change the network settings, if desired. If you are setting up a system that you know will never grow beyond 99 BLADE 3 units, then this is your best choice.
- **100+ Blades** – This would be your choice for a large system. When you choose this size the setup wizard will automatically assign network settings to the BLADE 3 based on your choice of Blade ID. For IDs in the range of 1 to 99, IP addresses will be assigned within the 192.168.87.xxx subnet, with the last octet being assigned a value of 100 plus the Blade ID. The subnet mask will be set to 255.255.0.0, and the gateway will be set to 192.168.87.1. For IDs in the range of 100 to 199, IP addresses will be assigned within the 192.168.88.xxx subnet, with the last octet being assigned a value equal to the Blade ID. The subnet mask will be set to 255.255.0.0, and the gateway will be set to 192.168.88.1. Once you have gone through the complete **Blade Setup** process you will be able to change the network settings, if desired. If you are setting up a system with more than 100 BLADE 3 units, or a system that you know will grow beyond 99 BLADE 3 units in the future, then this is your best choice.
- **Snake (2 Blades)** – This would only be your choice if, and only if, your system has exactly 2 BLADE 3 units, *and* you want them to act as a basic audio snake, routing audio from the first BLADE 3 inputs directly to the second BLADE 3

outputs, and *vice versa*, with no option to change the routing. In this case one BLADE 3 *must* be set up in the Snake sub-menu as **Snake A** and the other *must* be set up as **Snake B**.

Scroll the knob to the desired system size and click the right arrow button to accept that size. If you have chosen either **1-99 Blades** or **100+ Blades** you will then need to select a BLADE 3 Blade ID. Note that each BLADE 3 in the system must have a unique Blade ID. If you are choosing the **Snake** mode you will be asked to choose between **Snake A** and **Snake B**, as indicated above.

Once you have completed the decision process for system size, the setup wizard will display the settings on the right side OLED display. Press the right arrow button to advance to the next decision, that of **Default Sample Rate**. Here there are only two choices: **48K** (48kHz), or **44K** (44.1kHz). If you are not sure which one to select, and you are not working with audio for television, use **44K**. You can change the sample rate at a later time if needed. Scroll to the desired selection and press the right arrow button.

The final choice you need to make is which **I/O Template** to use. Here are the three choices, and their significance:

- **Stereo I/O** – This would be the most common choice if your facility consists primarily of equipment with stereo inputs and outputs, such as tape machines, CD players, computers, etc. When this template is employed the setup wizard will configure the inputs and outputs of the BLADE 3 as stereo signals and add these signals to the system. If you choose this template, you can later on change some of your signals to mono if necessary.
- **Mono I/O** – This would be the most common choice if your facility consists primarily of monophonic equipment, such as microphones, phone systems, etc. When this template is employed the setup wizard will configure the inputs and outputs of the BLADE 3 as mono signals and add these signals to the system. If you choose this template, you can later on change some of your signals to stereo if necessary. Please note that if you have a lot of mono sources you may be tempted to use this template, but you should also consider the rest of your audio equipment; you may actually still have more stereo signal requirements than mono ones.
- **Custom** – This would be a tempting choice if you have a fairly even balance between mono and stereo signals in your facility. However, if you choose this template the setup wizard will not configure the BLADE 3 inputs and outputs, nor will it add input and output signals to the system. With this template, you will need to create the signals for each input and output connection.

Once all the choices have been made, the setup wizard will complete the configuration process. The right side OLED display will indicate that the BLADE 3 is entering the system:



Once the BLADE 3 has joined the system its basic information will show on the OLED displays:



When the front panel controls are idle for a while the OLED displays will show the Screen Saver:



BLADE 3 Front Panel Configuration



Activating any of the front panel controls will replace the screen saver display with the main menu screen.



Press the left arrow button  twice to open up the BLADE 3 information screens:

On the left window of the Info screens you will find your digital system clock rate, that can be either 44.1K, 48K, External Reference, or AES 67. The “Master” on the top row will be displayed if this BLADE 3 assumes the role as



system master over the rest of the BLADE 3s in your network, or a square wave icon shows if this BLADE 3 is acting as the clock master. The BLADE 3’s Name, ID number, and inside temperature also display in this window. The RJ-45 connector icon will show green and have moving dots next to it if the BLADE 3 is connected to the network. If it is not connected the RJ-45 icon will show red and there will be no dots.

The right window of the Info screens displays whether the BLADE 3’s signal meters are displaying input or output, and also shows the BLADE 3 IP Address and Uptime.

Pressing the left arrow button again will take you back to the screen saver display.

Clockwise rotation of the knob navigates up and down a menu when there is a list, or scrolls thru options in a submenu once one has been selected. Pressing the right arrow button navigates through sub-menu options. Pushing the knob “takes” an option. 

To edit any parameter or name, press the right arrow button to highlight the parameter. Turn the knob to find the desired value or character, then press the right arrow button to take it. If the parameter has more than one field you can press the knob to cycle through the fields.

The  button backs out of a submenu to the main menu.

For example, when you select *Headphone...* by pressing the right arrow button the main menu list will be displayed in the left window and *Headphone Level* and *Connected Status* show in the right window.



To adjust the volume level, turn the knob to highlight *Headphone Level* and push the knob. You can then adjust the volume to a safe and comfortable level by turning the knob. Once complete, push the knob to exit the adjustment mode.

Press the  button to get back to the main menu.

For *Gain Levels...* select *Sources...* or *Destination...*



that brings up screens with list of sources (shown) or destinations and gain levels.



Try your hand at making some adjustments to help you get more familiar with the front panel controls.

The main menu of the BLADE 3 shows all of the options available from the front panel. These options are:

- **Headphone...** – Selects the headphone source and volume level.
- **Inputs...** – Sets the gain structure and phantom power (BLADE 3 Mic type only).
- **Blade...** – Displays current info of the BLADE 3, software and hardware version, external clock reference, and network settings. These settings can also be edited from this submenu.
- **Display...** – Sets the display's brightness and screen saver time.
- **Gain Levels...** – Displays the gain levels for selected sources and destinations and allows the user to set the input level for each source and destination.
- **Utility Mixer...** – Each BLADE 3 has two Utility Mixers. Their features include panning, channel On/OFF, fader levels, and access to any source signal in the system. They also include a full ACI (Automation Control Interface) allowing remote control, ducking, auto fade, channel on/off, levels, source assign, etc.
- **Routing...** – Routes any audio input to any output or all outputs.
- **Status...** – Displays Uptime, Runtime, Date/Time, Temperature, ANNC Pkts/Errors, LIO Pkts/Errors, and GUI information, Surface availability (BLADE 3 Engine or Console types only), Route and Clock Master status.
- **Meters...** – Sets the front panel meter mode for BLADE 3 to show the input signal levels for each source or output signal levels for each destination.
- **Logic...** – Displays LIO Status and allows testing of the LIO outputs.
- **Password...** – Allows you to set a password to secure front panel access.

Front Panel Menu Diagram

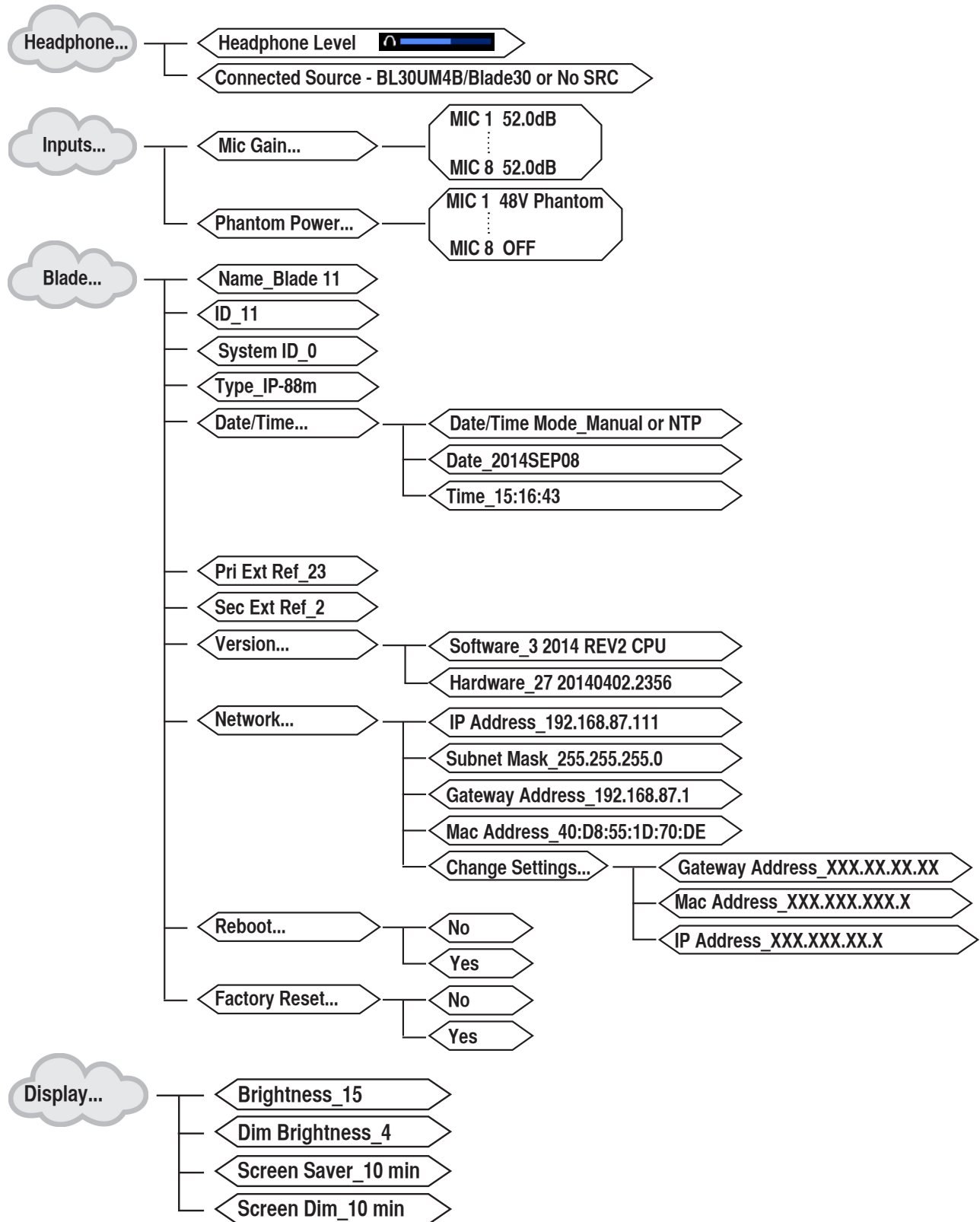

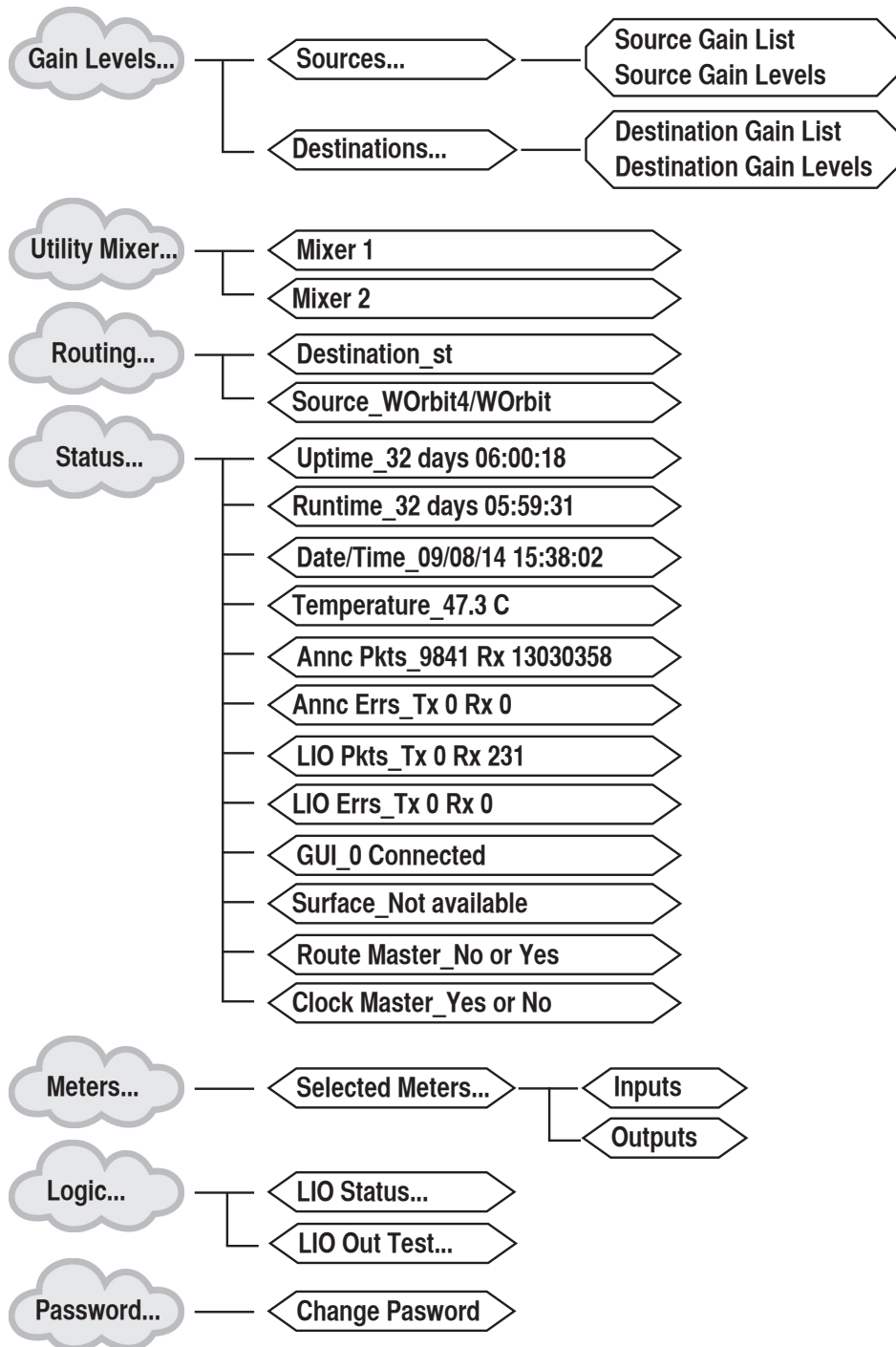

Surface Setup

If you have a Mix Engine BLADE, it can be used with a Wheatstone E-Series surface or LX-24 to provide mixing capability. In order to be used in a BLADE system, the surface must first be properly configured.

Network Settings

When the control surface is powered up the first time it will display a dialog box stating that no network file was found (*See Figure 1*).



Figure 1

To configure the network settings for the control surface select “YES” from the dialog box. The surface will now display the Options Tab (*See Figure 2*). Here you will set the BLADE ID and IP address of the Engine to which the surface will connect, along with the Surface IP Address, Subnet Mask, and Gateway. If Automatic mode is selected, enter the BLADE ID of the Mix Engine BLADE to be associated with the surface and the remaining settings are configured for you. You can manually enter this information by turning off Automatic mode and using the numbered keypad on the screen. When done simply press APPLY to finalize these settings and the surface will request a reboot (*See Figure 3*).



Figure 2

A	Configuration Mode	This is where you select the Configuration mode desired. The choices are Automatic or Manual.
B	Mix Engine ID	This is where the ID of the Mix Engine BLADE that will be associated with the surface is assigned. One Mix Engine BLADE supports a single surface.
C	BLADE Status	This is the BLADE connection status. If properly configured and connected to an Engine, status will be “CONNECTED.” If improperly configured the status will read “DISCONNECTED.”

For convenience, Wheatstone uses the following convention for IP Addressing in the WheatNet-IP system:

1. The IP Address of a BLADE is equal to the BLADE ID plus 100; i.e. BLADE #3 = 192.168.87.103
2. The IP Address of a control surface is equal to the Engine BLADE ID plus 200; i.e. Engine BLADE = 5, Surface IP Address = 192.168.87.205

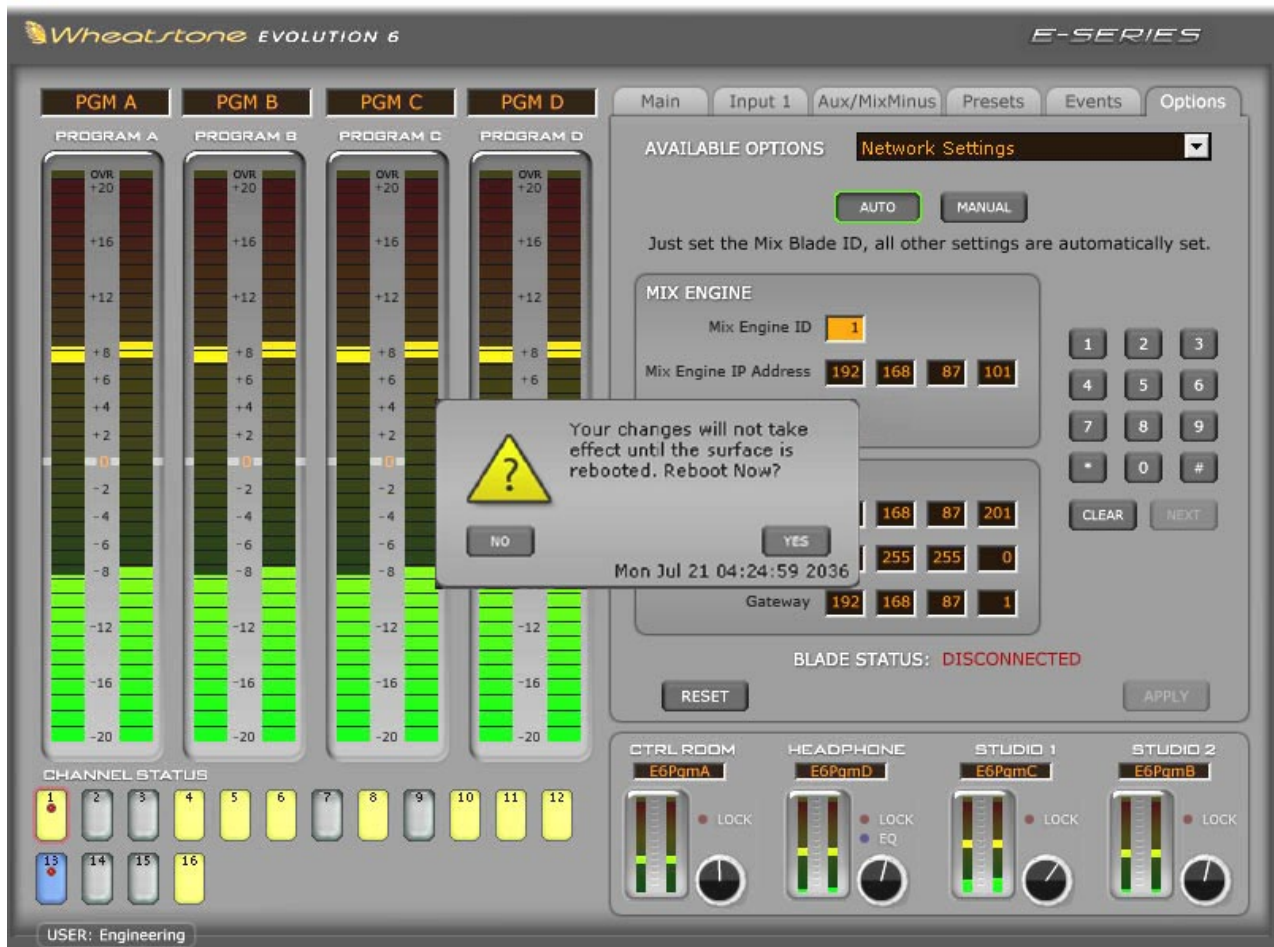

Figure 3

Select YES from the dialog box and the surface will reboot. Once the surface has been rebooted navigate to the Options Tab and select Network Settings from the drop down menu. If all information was entered properly the BLADE STATUS will display “CONNECTED” (See Figure 4). The control surface has been successfully configured.



Figure 4

WheatNet-IP BLADE3 System

Table of Contents

Chapter 1 - General Information

Introduction.....	1-3
Rack Mounting.....	1-5
Installation Tips	1-5
Energizing	1-6
A Word About Nomenclature.....	1-6
WheatNet-IP BLADE3 System Description.....	1-8
BLADE3 Front Panel Controls.....	1-9
IP88a - Analog BLADE3	1-10
IP88d - Digital BLADE3	1-10
IP88ad - Analog/Digital BLADE3	1-11
IP88m - Microphone BLADE3	1-12
IP88cb/88cbe/88cbl/32cb - Console BLADE3.....	1-12
IP88e - Mix Engine BLADE3.....	1-14
IP88lxe - LXE Mix Engine BLADE3.....	1-14
Aura8ip - Vorsis Embedded BLADE3	1-15
Signal Configuration.....	1-15
MADI - Multichannel Audio Digital BLADE.....	1-16
M4IP - Microphone Processing BLADE3	1-17
HD-SDI - Audio De-Embedded BLADE3	1-18
LIO-48 - Multiple Port Logic I/O BLADE	1-18
EDGE Network Interface	1-19
Network Switches	1-20
CAT5e/CAT6 Wiring.....	1-21
AoIP Driver	1-21
Software Tools.....	1-21
Audio Devices	1-21
I/O Connections	1-22
Model IP88a.....	1-22
Inputs.....	1-22
Outputs.....	1-24
Models IP88d.....	1-26
Inputs.....	1-26
Outputs.....	1-27
Model IP88ad.....	1-28
Inputs.....	1-28
Outputs.....	1-30
Model IP88m.....	1-31
Inputs.....	1-31
Outputs.....	1-32
Model IP88cb/88cbe/88cbl.....	1-33
Inputs.....	1-33
Outputs.....	1-34

Model Aura8ip 1-36
 Inputs..... 1-36
 Outputs..... 1-37
 Model MADi..... 1-39
 Digital Audio Connections..... 1-39
 Optical Fiber Interface..... 1-39
 Model M4iP 1-40
 Inputs..... 1-40
 Outputs..... 1-41
 Model HD-SDI 1-42
 Logic Ports - All Models (except LIO-48) 1-42
 LIO-48 Logic Ports 1-43
 Simplified BLADE Logic I/O 1-45
 Input Logic 1-45
 Output Logic..... 1-45
 Analog 88a BLADE3 - Input/Output Pinout Drawing 1-46
 Digital 88d BLADE3 - Input/Output Pinout Drawing..... 1-47
 Analog/Digital 88ad BLADE3 - Input/Output Pinout Drawing..... 1-48
 Analog MIC 88m BLADE3 - Input/Output Pinout Drawing 1-49
 Console 88cb/88cbe/88cbl BLADE3 - Input/Output Pinout Drawing 1-50
 Engine 88e/88ixe BLADE3 - Input/Output Pinout Drawing 1-51
 Vorsis Embedded Aura8ip BLADE3 - Input/Output Pinout Drawing 1-52
 Multichannel Audio Digital MADi BLADE - Input/Output Pinout Drawing..... 1-53
 Microphone Processing M4iP BLADE3 - Input/Output Pinout Drawing..... 1-54
 Audio De-Embedded HD-SDI BLADE3 - Input/Output Pinout Drawing 1-55
 Multiple Port Logic I/O LIO-48 BLADE - Input/Output Pinout Drawing 1-56
 EDGE Network Interface - Input/Output Pinout Drawing..... 1-57

Chapter 2 - BLADE3 Setup and Configuration

BLADE3 Setup Mode..... 2-2
Front Panel Configuration 2-5
 Front Panel Menu Diagram..... 2-7

Chapter 3 - WheatNet-IP Network

WheatNet-IP Networks and What They Do..... 3-2

Chapter 4 - Ethernet Networks and Switches

Overview..... 4-2
Gigabit Ethernet Technology..... 4-2
Choosing Ethernet Switches..... 4-2
 Switch Feature Considerations 4-2
 Unmanaged vs. Managed Switches..... 4-3
 Rules of Thumb 4-3
 What's on the Wire? 4-4
Designing the WheatNet-IP Network 4-5
 Where to Start 4-5

Cabling	4-5
GbE Network Cabling Guidelines.....	4-6
1000BASE-T vs. 1000BASE-TX	4-6
Wireless Connectivity	4-6
Configuring the Network	4-6
Managed Switch Configuration.....	4-6
Default LAN Parameters.....	4-6
BLADE3 Configuration	4-7
Surface Configuration	4-8
PC Configuration.....	4-10
Network Interface Card (NIC)	4-10
Typical Small Network Block Diagram	4-11
Typical Medium Network Block Diagram	4-12
Typical Large Network Block Diagram	4-13
Network Troubleshooting	4-14
Useful ICMP Commands.....	4-14
Software Tools.....	4-14
Simple Network Management Protocol (SNMP)	4-14
Hardware Status Indicators.....	4-15
Error Logs.....	4-15
PC GUI Log	4-15
Alarms	4-16

Chapter 5 - WheatNet-IP Navigator GUI

Description.....	5-4
Using the Navigator GUI	5-5
An Important Point About WheatNet-IP Systems and System Master.....	5-18
Navigator GUI System Windows in Detail	5-19
Crosspoint Tab	5-19
Crosspoint Details Menu	5-21
Choose View	5-21
Fire Salvo.....	5-21
Destinations Sort By.....	5-21
Sources Sort By	5-22
Show	5-22
Destination Details Menu	5-22
Choose View	5-22
Fire Salvo.....	5-23
Destinations Sort By.....	5-23
Show	5-23
Rename Signal	5-24
Modify Signal.....	5-24
Lock Signal.....	5-26
Source Details Menu	5-27
Choose View	5-27
Sources Sort By	5-27
Show	5-27
Rename Signal	5-28
Modify Signal.....	5-28

Salvos/Macros Tab.....	5-30
Info Tab.....	5-32
Clock Master Info.....	5-32
Set Date and Time.....	5-33
Front Panel Passcode.....	5-34
Version Check.....	5-34
Blade Display Settings.....	5-35
LIO Properties Tab.....	5-36
Associated Connections Tab.....	5-38
Triggered Connections.....	5-38
Associated Connections.....	5-38
Config Manager Tab.....	5-39
Configuration Folder.....	5-39
Backup System Configuration.....	5-40
Current Crosspoint.....	5-40
Signal Info Text.....	5-40
Restore System Configuration.....	5-40
Version Manager Tab.....	5-41
Preferences Tab.....	5-42
General Section.....	5-42
Default View.....	5-42
Default Grid Labels.....	5-42
Default Sort Order.....	5-43
Check Boxes.....	5-43
Colors.....	5-44
Blade Preferences.....	5-46
Logger.....	5-47
Network.....	5-47
Log Tab.....	5-48
Locator Tab.....	5-49
Navigator GUI Devices Windows in Detail.....	5-50
Surfaces Tab.....	5-50
Peripheral Devices Tab.....	5-51
ACI Devices Tab.....	5-51
AES67 Devices Tab.....	5-52
Devices.....	5-52
Device Info.....	5-52
GBT Cards Tab.....	5-52
Navigator GUI BLADE3 Windows in Detail.....	5-53
Sources Tab.....	5-54
Source Signals.....	5-54
Free Resources.....	5-55
Add Button.....	5-56
Add Alias Button.....	5-56
Edit Button.....	5-57
Delete Button.....	5-58
Meters.....	5-58
Destinations Tab.....	5-60
Destination Signals.....	5-60
Free Resources.....	5-61
Add Button.....	5-62

TABLE OF CONTENTS

Add Alias Button	5-63
Edit Button	5-63
Delete Button	5-63
Meters	5-64
Wire Info Tab.....	5-65
Visibilities Tab	5-66
LIO Info Tab	5-68
Silence Detect Tab	5-70
Destination Signals.....	5-71
Settings	5-71
Status	5-72
Logic.....	5-72
Utility Mixer Tab.....	5-73
Blade Info Tab	5-75
Config Manager Tab.....	5-77
A Word About Backup and Restore	5-78
Audio Player Tab	5-79
Status	5-79
Playlist	5-79
Capacity	5-79
Modify Playlist	5-80
Playback Control	5-80
More on System Pane	5-81

Chapter 6 - Aura 1 ip ProGUI

Routable Audio Processing.....	6-3
A Word About Our Controls	6-5
Input Controls	6-5
High Pass Filter (HPF)	6-5
AGC and Compressor Controls - Part 1	6-5
AGC Backoff.....	6-6
Band Coupling.....	6-7
Gate Thresh, Gate Delay, and Gated Mode	6-7
Number of Bands	6-8
Crossovers	6-8
AGC and Compressor Controls - Part 2	6-9
Threshold.....	6-10
AGC Attack/Release.....	6-10
Compressor Attack/Release	6-10
Compressor Ratio	6-11
Gate Offset	6-11
Processing Band L+R and L-R Outputs.....	6-12
Makeup Gain	6-13
Parametric EQ.....	6-14
A Word About Our Limiters	6-16

Multiband Limiter.....	6-16
Threshold	6-16
Limiter Attack	6-17
Limiter Release.....	6-17
Output Trim.....	6-17
Multiband Limiter Options.....	6-17
Look Ahead Final Peak Limiter	6-18
Final Lim Drive.....	6-18
Attack	6-18
Release.....	6-18
Delayed Release Control.....	6-18
Look Ahead Limiter Special Option Checkboxes	6-18
Output Control.....	6-19
Metering Discussion	6-20
Input Metering	6-20
Gain Reduction Meters	6-20
Output Metering	6-21
Sidebar Region	6-22
Preset	6-22
Library	6-23
Devices.....	6-24
Quick Save	6-24
Title Bar Region	6-26
Status	6-26
Devices.....	6-26
Presets	6-26
Accessing Menu Option.....	6-27
File Menu Items.....	6-27
Hardware Menu Items	6-27
Preset Menu Items	6-27

Appendices

Appendix 1

Configuring Control Surfaces for Use in WheatNet-IP Systems A-7

Appendix 2

Cisco 2960G, 2960S, and 2960X Configuration for WheatNet-IP.A-14

Overview.....	A-14
Privileged EXEC Mode	A-15
Global Configuration Mode	A-15
Configuring the VLAN Interface.....	A-15
IGMP Snooping Querier Configuration	A-16
Configuring Gigabit Ports Connecting to WheatNet-IP I/O BLADE3s and PC Drivers	A-16
Configuring Gigabit Ports Connecting to WheatNet-IP Control Surfaces,	

GP Panels, and XY Controllers.....A-17

Configuring Ports for Linking to Other Network SwitchesA-18

Checking and Saving the Switch Configuration.....A-18

Cisco 3750G, 3560G, 3650, and 3850 Configuration for WheatNet-IP..A-19

Overview.....A-19

Privileged EXEC ModeA-20

Global Configuration ModeA-20

 Configuring the VLAN Interface.....A-20

IGMP Snooping Querier ConfigurationA-21

Configuring Gigabit Ports Connecting to WheatNet-IP I/O BLADE3s
and PC DriversA-21

Configuring Gigabit Ports Connecting to WheatNet-IP Control Surfaces,
GP Panels, and XY Controllers.....A-22

Configuring Ports for Linking to Other Network SwitchesA-23

Checking and Saving the Switch Configuration.....A-23

HP Procurve 2810 Configuration for WheatNet-IPA-24

Overview.....A-24

Privileged EXEC ModeA-25

Global Configuration Level.....A-25

 Configuring the VLAN Interface.....A-25

IGMP Querier Configuration.....A-26

Configuring Gigabit Ports Connecting to WheatNet-IP I/O BLADE3s
and PC DriversA-26

Configuring Gigabit Port Connecting to WheatNet-IP Navigator PC.....A-27

Configuring Gigabit Ports Connecting to WheatNet-IP Control Surfaces,
GP Panels, and XY Controllers.....A-27

Configuring Ports for Linking to Other Network SwitchesA-27

Checking and Saving the Switch Configuration.....A-27

Appendix 3

WheatNet-IP Logic Functions and ExamplesA-30

Category 1: Direct LogicA-30

 VDip Function.....A-30

 Programmable ButtonsA-33

Category 2: Audio Associated Logic.....A-38

Category 3: Discrete Logic.....A-43

Category 4: Action Logic.....A-47

Appendix 4

External ControllersA-49

Appendix 5

WheatNet-IP WDM Driver InstallationA-51

Hardware Requirements.....A-51

Software Requirements.....A-51

InstallationA-51

 Application Note.....A-54c

Configuration.....	A-55
System Parameters	A-55
Software License.....	A-55
Removing the Drivers	A-57

Appendix 6

IP-MTR64 Meters GUI	A-59
Introduction To IP-MTR64 Meters GUI	A-59
IP-MTR64 Meters GUI Overview	A-59
IP-MTR64 Meters GUI Features	A-59
Installation	A-60
Requirements	A-60
Performing The Install	A-60
Adding The IP-MTR64 Meters GUI To The Peripheral Devices Tab	A-63
Program Operation - Getting Started	A-64
License Key	A-64
First Time Operation.....	A-65
Network Setup	A-65
“Discovering” The System Components.....	A-67
Setting Up Meters	A-69
Configuring A Meter Cell	A-69
Using The Analysis Window	A-70
Changing The Meter Layout.....	A-70
Configuring Silence Detect Alarms	A-71
Security Settings	A-73
Setting The Password	A-73
Operating With Security	A-73
Making The Security Settings	A-73
Menus.....	A-74
View	A-74
Layout.....	A-74
WheatNet-IP System.....	A-74
Setup	A-74
Additional Popup Menus.....	A-75
Summary	A-75

Appendix 7

WheatNet-IP Scheduler	A-78
Introduction To Wheatnet-IP Scheduler	A-78
Events And Signals	A-78
Installation	A-79
Requirements	A-79
Performing The Install	A-79
Uninstalling The Program	A-82
First Time Operation.....	A-82
License Key	A-82
First Time Operation When Connected To A System.....	A-83

TABLE OF CONTENTS

When Connection To A BLADE3 Succeeds at Startup.....	A-85
When Connection To A BLADE3 Fails at Startup	A-86
Day To Day Operation	A-87
System	A-87
Set IP Address.....	A-87
Define Devices.....	A-88
Signals.....	A-89
Request Signals From Connected BLADE3	A-89
Load Signals From File.....	A-89
Save Signals To File	A-90
Events.....	A-90
Load Events From File.....	A-90
Save Events To File	A-90
Create Events	A-90
View Events	A-91
Edit Events	A-94
Schedule Events.....	A-95
Delete Events	A-95
Schedule Management	A-96
Moving Items.....	A-96
Deleting Items	A-97
Enabling and Disabling Items.....	A-97
Exiting With A Schedule Running.....	A-98
More On Existing.....	A-98
Logs.....	A-98
Viewing Logs	A-99
Menus.....	A-99
File.....	A-99
Edit	A-100
Events.....	A-100
Schedule	A-100
Signals.....	A-101
Help	A-101
Event Log Menu	A-101
Event Log Menu - File	A-101
Event Log Menu - Edit.....	A-101

Appendix 8

WheatNet-IP PC-XY Software Configuration Guide	A-103
Overview.....	A-103
Installing The Software	A-103
Network Considerations	A-103
Logging In.....	A-104
Menus.....	A-104
Setting BLADE3 IP Address.....	A-104
Using Source / Destination Windows.....	A-105
Logging Out.....	A-105
Visibilities.....	A-105
Hot Button Programming	A-106

Appendix 9

Introduction to Screen Builder.....A-108

Appendix 10

Introduction to OLED Switch Panels.....A-111

Appendix 11

WheatNet-IP and AES67.....A-113

System RequirementsA-114

 Timing.....A-114

 Packet Structure.....A-115

 Multicast Address ChangeA-116

 PortsA-116

Using WNIP with AES67.....A-117

 Example 1: Bringing in audio streams from an Axia xNode using 1/4ms
 packet timing.....A-121

 Example 2: Bringing in audio streams from an Axia xNode using 1ms
 packet timing.....A-125

 Example 3: Sending a WNIP audio stream to an Axia xNode using 1/4ms
 packet timing.....A-128

 Example 4: Sending a WNIP audio stream to an Axia xNode using 1ms
 packet timing.....A-131

 SDP Files.....A-133

SummaryA-135

 Some Screen Shots of Various Vendors Configuration Screens.....A-136

General Information

Chapter Contents

Introduction	1-3
Rack Mounting	1-5
Installation Tips	1-5
Energizing	1-6
A Word About Nomenclature	1-6
WheatNet-IP BLADE3 System Description	1-8
BLADE3 Front Panel Controls.....	1-9
IP88a - Analog BLADE3	1-10
IP88d - Digital BLADE3	1-10
IP88ad - Analog/Digital BLADE3	1-11
IP88m - Microphone BLADE3	1-12
IP88cb/88cbe/88cbl/32cb - Console BLADE3.....	1-12
IP88e - Mix Engine BLADE3.....	1-14
IP88lxe - LXE Mix Engine BLADE3.....	1-14
Aura8ip - Vorsis Embedded BLADE3	1-15
Signal Configuration.....	1-15
MADI - Multichannel Audio Digital BLADE	1-16
M4IP - Microphone Processing BLADE3	1-17
HD-SDI - Audio De-Embedded BLADE3	1-18
LIO-48 - Multiple Port Logic I/O BLADE	1-18
EDGE Network Interface	1-19
Network Switches	1-20
CAT5e/CAT6 Wiring.....	1-21
AoIP Driver	1-21
Software Tools.....	1-21
Audio Devices	1-21
I/O Connections	1-22
Model IP88a	1-22
Inputs.....	1-22
Outputs.....	1-24
Models IP88d	1-26
Inputs.....	1-26
Outputs.....	1-27
Model IP88ad.....	1-28
Inputs.....	1-28
Outputs.....	1-30
Model IP88m.....	1-31
Inputs.....	1-31
Outputs.....	1-32
Model IP88cb/88cbe/88cbl.....	1-33
Inputs.....	1-33
Outputs.....	1-34

Model Aura8ip 1-36
 Inputs..... 1-36
 Outputs..... 1-37
 Model MADi..... 1-39
 Digital Audio Connections..... 1-39
 Optical Fiber Interface 1-39
 Model M4IP 1-40
 Inputs..... 1-40
 Outputs..... 1-41
 Model HD-SDI 1-42
 Logic Ports - All Models (except LIO-48) 1-42
 LIO-48 Logic Ports 1-43
 Simplified BLADE Logic I/O 1-45
 Input Logic 1-45
 Output Logic..... 1-45
 Analog 88a BLADE3 - Input/Output Pinout Drawing 1-46
 Digital 88d BLADE3 - Input/Output Pinout Drawing 1-47
 Analog/Digital 88ad BLADE3 - Input/Output Pinout Drawing..... 1-48
 Analog MIC 88m BLADE3 - Input/Output Pinout Drawing 1-49
 Console 88cb/88cbe/88cbl BLADE3 - Input/Output Pinout Drawing 1-50
 Engine 88e/88lx BLADE3 - Input/Output Pinout Drawing 1-51
 Vorsis Embedded Aura8ip BLADE3 - Input/Output Pinout Drawing 1-52
 Multichannel Audio Digital MADi BLADE - Input/Output Pinout Drawing..... 1-53
 Microphone Processing M4IP BLADE3 - Input/Output Pinout Drawing..... 1-54
 Audio De-Embedded HD-SDI BLADE3 - Input/Output Pinout Drawing 1-55
 Multiple Port Logic I/O LIO-48 BLADE- Input/Output Pinout Drawing..... 1-56
 EDGE Network Interface - Input/Output Pinout Drawing..... 1-57



General Information

Introduction

Congratulations on acquiring the Wheatstone third-generation intelligent WheatNet-IP system. The WheatNet-IP technology allows you to build a networked audio system of I/O devices, control surfaces, computers, and controllers, all without using a dedicated audio router. How do we do this? By using a LAN (Local Area Network) itself to connect the various devices together and distribute audio and logic data where needed.

Each WheatNet-IP device (we call them “BLADE3”) has its own intelligence/operating system that allows it to be a powerful standalone router, be part of a larger system, or control the entire routing system. WheatNet-IP is an embedded system that does not require outside intervention or control from 3rd party software running on PC’s. The configuration of the entire network is stored in each BLADE3.

Each BLADE3” functions primarily as an audio access point, where analog or digital audio signals are connected to this network. BLADE3s are built to handle native analog, microphone, AES/EBU, SPDIF, AOIP, MADI, SDI and AES 67. Once any type of audio is ingested into the WheatNet-IP network, any type of audio input can be converted to any other type of output. Example: analog to digital, AES to IP, MADI to AES 67, mics to AOIP, etc. All BLADE3s are AES67 compatible for use with other AES67-compatible systems and devices.

Within the WheatNet-IP unit, the audio channels are converted to packets of data that can travel over an Ethernet LAN. The Ethernet switches that compose the core of the LAN directly control the distribution of packets and perform the “switching” function of a traditional audio router. Once the audio packets have been forwarded to the desired destination end point (typically a PC or another WheatNet-IP device), they are reassembled into an audio signal and made available. Ability to support AES67 compliant devices allows WheatNet-IP system to synchronize to IEEE1588 from a PTP grandmaster clock and ingest /stream AES67 compliant packets.

By converting audio into data packets, the traditional audio wiring infrastructure of multipair cables, trunk lines, patch bays, and punchblocks is no longer needed. In fact all the distribution cables you need may already be in place – in the form of your LAN and its CAT6 cables. You’ll only need to wire your source and destination devices to “BLADE3” to complete your system. Best of all, the dozens of audio cables and hundreds of logic connections you used to need to connect up each audio console have been replaced with a single CAT6 cable to the control surface. What could be easier?

Each BLADE3 contains two stereo 8x2 internal mixers that become a source or input to the system. This can be useful for grouping several mics to a single output. You can use the output of each mixer as a talkback source. The BLADE3’s mixers are independent of each other, so they can feed audio to each other or another BLADE3. The output of mixer #1 can be brought up on a fader in mixer #2, for example. With balance control on each fader, this can be useful for recording a telephone mix with the “callers” on the left

channel and the “announcers” on the right channel. The output of the mixer feeds the recording device. These internal mixers are full featured and include panning, channel ON/OFF, fader levels, and access to any source signal in the system. They also include a full ACI (Automation Control Interface) allowing remote control, ducking, auto fade, channel on/off, levels, source assign, etc.

Each BLADE3 has dual OLED displays for easily viewing and changing BLADE3 parameters. Colorful and high-resolution, these HDTV-like displays will give you more ways to interact with the unit, such as being able to adjust virtual mixing right from the front of the unit.

Source aliasing, or the ability to personalize sources and destinations is useful feature of the BLADE3. For example, the same mic can be labeled “Chris” for the morning show and “Pete” for the afternoon show.

There is an optional built-in audio clip player that can be used to put emergency audio on the air. The files are managed in Navigator where you can add files, organize the playlist, and fire playback with a logic port. Silence or LIO can trigger this playback or it can be manually controlled from Navigator.

Each BLADE3 has a stereo multiband processor with the following: 4-band parametric equalizer, three-way crossovers, three compressors, three limiters, and a final lookahead limiter. This is a “routable processor,” meaning it is not limited to the local I/O on the BLADE3 – it can be considered a network resource.

Each BLADE3 comes with 128 virtual logic ports for triggering, managing and controlling the many feeds that have become standard in radio stations today.

The Associated Connections is a great feature in BLADE3s for callers, codecs, networks, remote broadcast and live talk shows that require a mix-minus. Smart associated connections, to take the hassle out of changing connections between locations, studios or announcers. Simply define the link you need (ISDN, studio feed, remote, etc.) and BLADE3 can automatically set up a back link for it. Just trigger the connection and the back feed will follow – a helpful feature for remotes or for when you’re changing studios. Each I/O BLADE3 comes with multiple associated connections limited only by memory.

A word about latency – a finite and not insignificant delay from when audio or logic starts at the input of the system and when it appears at the output. Packet based audio networks have a reputation of having significant latency issues due to the performance of the earliest implementations, some of which had tens and even hundreds of milliseconds of latency. Each component of the system contributes to latency. On the input side, the A/D convertors (or Sample Rate Convertors for digital inputs) take a little time to do their work. Multiple samples of audio data must be accumulated and formed into packets before they are placed on the network. Ethernet switches take time to analyze the packets before they are sent on to their destinations, where they are disassembled and formed into audio streams which finally can be converted by D/A converters before the audio starts to play. All of this eats up a little bit of time at each step along the way. The WheatNet-IP system has been designed from the outset to use Gigabit networks, among other things, to minimize latency. Total latency from a BLADE3’s input through an Ethernet switch to a different BLADE3’s output is roughly 1/2 millisecond, which is well below the 5-10 millisecond human threshold of detection. Unfortunately, due to the non-real time nature of the Windows operating system and the fact that Windows requires buffers for audio streams, latency to/from a Windows PC remains on the order of 100 milliseconds.

Rack Mounting

The BLADE3 is designed to fit into an industry standard 19" equipment rack, and requires one rack unit (1.75 inches) of vertical space. Every BLADE3 model has a depth of 13-1/4" behind the rack rails (including chassis connectors), with the exception of the MADI BLADE3 with a 13-3/4" depth and LIO-48 BLADE3 with a 9-1/2" depth. An additional five inches of space is required for wiring cables to pass through. The chassis of all BLADE3 models has a width of 17-3/8". Space needed in front of rack rails is 3/4" for all BLADE3 models. The BLADE3 does not have top or bottom cover vent holes. Latent heat is vented out of the enclosure by natural convection through slots in the top of the rear panel. Cooler air is drawn into the unit through vertical slots positioned lower in the side panels. There is no fan inside the BLADE3 because its power consumption is low enough to not require one.

The BLADE3 may be mounted between other devices in the equipment rack and in accordance with good engineering practice should not be mounted directly above devices that generate significant amounts of heat. If such a location is unavoidable then it is advisable to utilize an extra 1RU blank rack panel between the BLADE3 and devices immediately above and/or below it. WheatNet-IP 88a analog BLADE3s in particular run hotter and should be installed with spaces in between to avoid detrimental heat build up.

WARNING! Under no circumstances should the WheatNet-IP unit be opened! The unit contains high voltage circuits that are hazardous and potentially harmful. The unit has no user-serviceable parts inside! If you have a problem the unit must be returned to Wheatstone Corporation for repair.

Installation Tips

- Place any surge protection circuits as close as possible to the BLADE3 or other device being protected.
- Establish a low impedance common ground in your facility and try to route all grounds to that point.
- Choose the best power conditioning / UPS units that you can afford and suitable for your equipment – focus on the features and options you need. The better UPS products can prevent thousands of dollars in equipment damage — some even come with an external equipment damage warranty.
- *Unbalanced* audio connections to the BLADE3 should be made with shielded two conductor cable such as Belden 8451 or 9451 as if connecting a balanced source. At the unbalanced source's output connect the + Output to the HI input wire and connect the source GND wire to the LO wire. Connect the shield at the BLADE3 end only.
- For digital audio connections always use a good quality digital audio cable with a characteristic impedance of 110 ohms.

The AES/EBU specification, with its broad impedance tolerance, allows for cables with impedances from 88 ohms to 132 ohms – 110 ohms is ideal. Twisted pair cable should be shielded, and in the case of multi-pair cable, each pair should be individually shielded. Foil shielding is recommended for permanent installations and foil shield plus overall braid should be used in applications where frequent flexing of the cable will occur. One cable pair is capable of carrying two channels of digital audio.

Generic “audio” cable such as Belden 8451 *may* be used for interconnecting AES3 digital audio devices but **only** for distances of less than about 25 feet. The actual cable length that will work satisfactorily in an installation is primarily determined by the error correction and jitter tolerance of the AES3 receiver device and the cable used.

The impedance of most ‘analog’ cables ranges from 40 ohms to 70 ohms and represents a large impedance mismatch from the nominal 110 ohms required in the AES3 standard. Such mismatch will result in signal reflections, causing bit errors at the AES3 receiver. The higher capacitance of generic analog cables also slows down the rise time of the digital data signals, impairing the ability of the AES3 receiver to accurately detect digital signal transitions. This may result in increased jitter.

Energizing

Assuming the BLADE 3 is correctly rackmounted, you may now energize it. There is no power switch. The AC line input voltage is permitted to be between 90 and 260VAC, 50 or 60Hz. Power consumption is under 100VA.

Aggressive AC input filtering is utilized at the AC input of the BLADE 3; however, it is always advisable to use external surge protection and/or an uninterruptible power supply (UPS), especially where AC power quality is questionable, such as at a remote transmitter site.

Power conditioning, surge suppression, and even power backup devices are wise investments when using sensitive modern electronic devices that use an internal computer.

Use of a UPS (uninterruptible power supply) is a good idea and will protect the BLADE 3 from short duration power interruptions which may cause it to reboot. During boot up, audio is interrupted for approximately 40 seconds.

A Word About Nomenclature

Throughout this manual references are made to “BLADE 3s,” “sources,” “destinations,” and other terms whose meanings may not be instantly understood by everyone. Let’s take a moment to clarify some terms.

1. BLADE 3. In the WheatNet-IP system a “BLADE 3” is taken to mean an individual member of a WheatNet-IP system; any device that has a unique BLADE 3 ID. It commonly refers to an individual input/output rackmount unit, but a more complete definition would include any network connected PC running a WheatNet-IP driver as well, including Automation servers and even the Program Director’s PC if they are running the WheatNet-IP driver to listen to audio streams. Conversely, any PC that is running the WheatNet-IP Navigator GUI program is not a BLADE 3 itself. Only those devices that can transmit and/or receive WheatNet-IP audio streams are “BLADE 3s.”

2. Source. A source is any audio signal in the WheatNet-IP system that is uniquely generated. Any WheatNet-IP signal that is created by accepting and packetizing an input is a source, as is any signal generated within the system. Source signals may be audio, logic, or both. A logic source might be a logic port triggered by an external switch. We generally avoid using the term “input” to describe WheatNet-IP signals because the term can be misleading. One would easily understand that an external audio input jack could be an “input” or “source,” but less obvious is the fact that an

audio mix bus output is also a WheatNet-IP source because it is generating a unique signal (the mix) and making it available to stream throughout the system. Likewise, PCs streaming audio from a file via the WheatNet-IP driver can clearly be seen as a “source.”

3. Destination. A destination is the opposite of a source. It is a signal that can accept any WheatNet-IP stream. A destination can take the received WheatNet-IP stream and convert it to a physical analog or digital output, or, in the case of a PC, a virtual output that subsequent PC application programs can convert to an audio output at the PC’s speakers, or lay down as an audio track on the hard disc. Destinations can be audio, logic, or both. A logic destination might be a logic port wired to a lamp or relay. We avoid using the term “output” for WheatNet-IP signals. While it is clear that a WheatNet-IP destination wired to an output jack is an “output,” control surface fader channels would not normally be considered “outputs” but they *are* “destinations” in the WheatNet-IP system, because you can route a WheatNet-IP audio stream to them.

4. LIO. Shorthand for **L**ogic **I**nput or **O**utput. In the WheatNet-IP system, an LIO signal is a signal that either generates or receives logic state information created either physically via a logic port or virtually via some state change within a mixing control surface. In the WheatNet-IP system logic information can be routed and cross connected just as audio can be.

5. GUI. Shorthand for **G**raphical **U**ser **I**nterface. A method of providing for user interaction with the system using a special computer program that displays information in the form of images and text on the computer screen and accepts user input via typing and mouse clicking within the computer program. The WheatNet-IP Navigator is a computer program that provides a GUI.

WheatNet-IP BLADE 3 System Description

Let's take a look at the parts of the WheatNet-IP system in more detail.

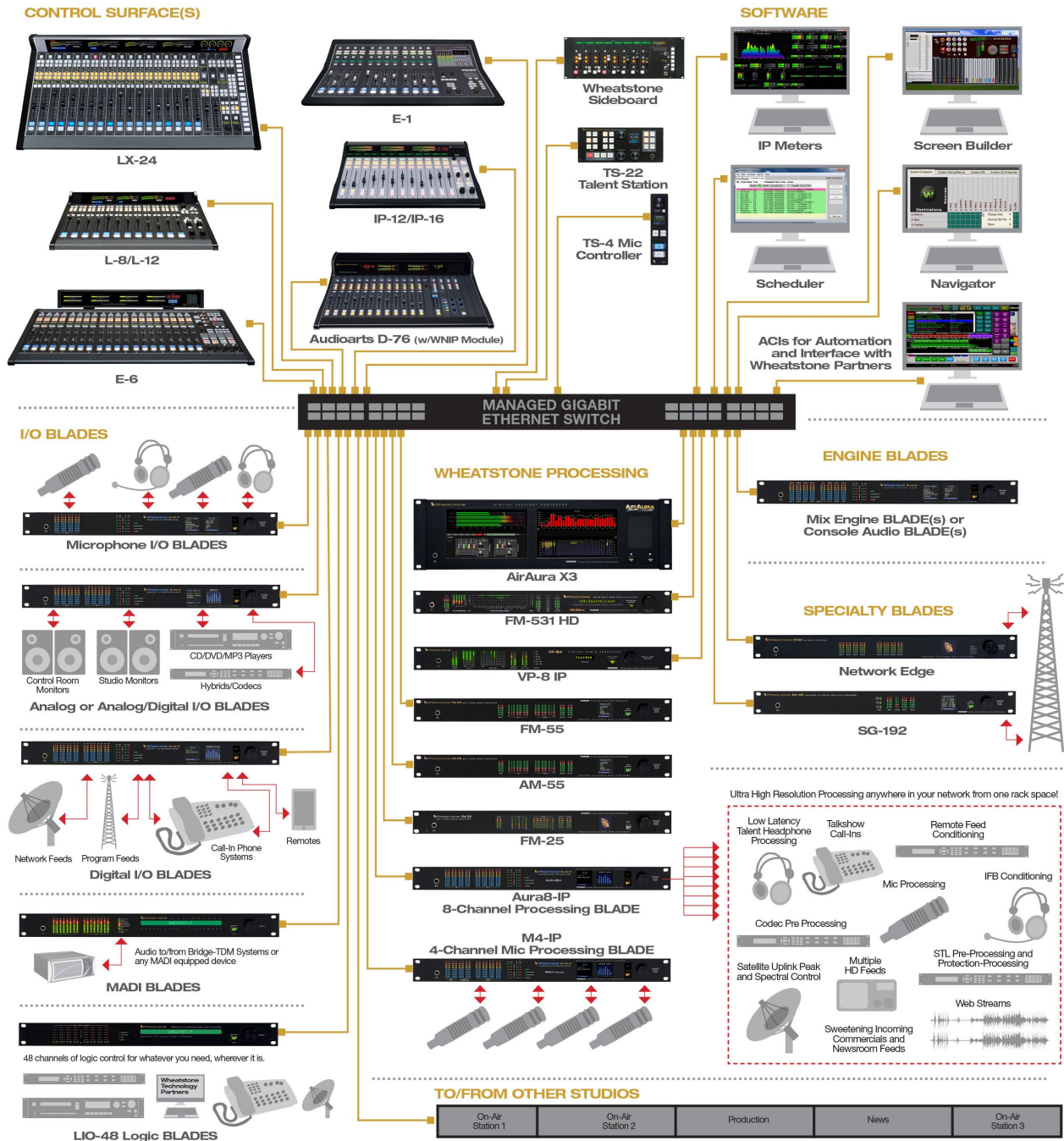

First there are the “BLADE 3s” themselves. The Wheatstone WheatNet-IP intelligent system includes following models of the BLADE 3: IP 88a Analog, IP 88d Digital, IP 88ad Digital/Analog, IP 88m Microphone, IP 88cb/cbe/cbl Console, IP 88e Mix Engine, and HD-SDI Network.

BLADE3 Front Panel Controls



The front panel of each BLADE 3 model houses metering for every input or output on the BLADE 3 – 12-segment, multi-color LEDs that can be used for metering inputs and outputs as 8 pairs or 16 mono signals. The exception to this is the IP88m Mic unit, which meters eight mono input signals. Please note that these meters show audio levels after any gain trimming has been applied, so if for some reason you have the gain for a particular channel cranked down, you may not see any meter indication even though audio is there.

Front panel logic indicators show status for active logic and direction (in or out) of the BLADE 3.

There also four system indicators:

- Link – Shows network connectivity.
- Route Master – Lights to show that the BLADE 3 is functioning as the System Master.
- Clock Master – Lights to show that the BLADE 3 is functioning as the system’s Clock Master.
- Error – Shows an error in network connectivity.

On the left-most side of front panel is a self-powered headphone jack with volume control. It allows you to select and monitor any source or mix on that BLADE 3 or in the entire system.

Each BLADE 3 comes with dual OLED displays for monitoring and control of most functions right from the front panel, including audio routing setup, monitoring, network information, alarm status, enabling and operating utility mixes, setting input and output gain, and connecting audio processing. Settings can also be done remotely using a PC.

The front panel’s two OLED displays, two buttons, and the knob quickly and easily allow you to set up and configure each BLADE 3 unit.

Rotation of the knob navigates up and down a menu when there is a list, or scrolls through options in a submenu once one has been selected. Pressing the right arrow button navigates through sub-menu options. Pushing the right arrow button or the knob “takes” an option. The  button backs out of a submenu to the main menu.

See Chapter 2 for details on the front panel menu options.

IP88a - Analog BLADE 3



IP88a is an access point for analog audio.

It has two DB-25 and eight RJ-45 connectors (the DB and RJ connections are in parallel so you can choose your preferred connector type) for 16 audio inputs. These can be set up as eight stereo, 16 mono, or any combination up to a maximum of 16 discrete channels.

It also has two DB-25 and eight RJ-45 connectors (again, use your preferred connector) for 16 audio outputs. These can also be set up as eight stereo, 16 mono, or any combination up to a maximum of 16 discrete channels.

It has two more RJ-45 connectors to provide 12 logic ports, which can be individually designated during set up as inputs or outputs. These ports are where you wire the various external switches, indicators, and control functions you need in your facility.

There are two RJ-45 jacks for Ethernet. One is for 1 Gigabit Ethernet – connect this one to your network. The 100 Megabit Ethernet port is not used – do not connect anything to this port.

Consult the wiring diagram at the page 1-46 for detailed information.

The unit has a standard IEC power connector. The BLADE 3s have an internal power supply that will accept 100-240 volts 50/60 hertz AC power.

IP88d - Digital BLADE 3



IP88d is an access point for digital audio.

It has two DB-25 and eight RJ-45 connectors (the DB and RJ connections are in parallel so you can choose your preferred connector type) for eight AES audio inputs. These can be set up as eight stereo, 16 mono, or any combination up to a maximum of 16 discrete channels. Please note that because AES audio signals represent two audio channels on one connection, some of the input connections on the IP88d are unused.

It also has two DB-25 and eight RJ-45 connectors (again, use your preferred connector) for eight AES audio outputs. These can be set up as eight stereo, 16 mono, or any combination up to a maximum of 16 discrete channels. Please note that because

AES audio signals represent two audio channels on one connection, some of the output connections on the IP88d are unused.

It has two more RJ-45 connectors to provide 12 logic ports, which can be individually designated during set up as inputs or outputs. These ports are where you wire the various external switches, indicators, and control functions you need in your facility.

There are two RJ-45 jacks for Ethernet. One is for 1 Gigabit Ethernet – connect this one to your network. The 100 Megabit Ethernet port is not used – do not connect anything to this port.

Consult the wiring diagram at the page 1-47 for detailed information.

The unit has a standard IEC power connector. The BLADE 3s have an internal power supply that will accept 100-240 volts 50/60 hertz AC power.

IP88ad - Analog/Digital BLADE 3



IP88ad is a hybrid access point for analog and digital audio.

It has two DB-25 and eight RJ-45 connectors (the DB and RJ connections are in parallel so you can choose your preferred connector type) for audio inputs. These can be set up as eight stereo, 16 mono, or any combination up to a maximum of 16 discrete channels. The first DB-25 and the first four RJ-45 jacks are set up as analog inputs. The second DB-25 and the last four RJ-45 jacks are set up as AES digital inputs.

It also has two DB-25 and eight RJ-45 connectors (again, use your preferred connector) for audio outputs. These can be set up as eight stereo, 16 mono, or any combination up to a maximum of 16 discrete channels. The first DB-25 and first four RJ-45 jacks are set up as analog outputs. The second DB-25 and the last four RJ-45 jacks are set up as AES digital outputs.

It has two more RJ-45 connectors to provide 12 logic ports, which can be individually designated during set up as inputs or outputs. These ports are where you wire the various external switches, indicators, and control functions you need in your facility.

There are two RJ-45 jacks for Ethernet. One is for 1 Gigabit Ethernet – connect this one to your network. The 100 Megabit Ethernet port is not used – do not connect anything to this port.

Consult the wiring diagram at the page 1-48 for detailed information.

The unit has a standard IEC power connector. The BLADE 3s have an internal power supply that will accept 100-240 volts 50/60 hertz AC power.

IP88m - Microphone BLADE 3



IP88m is an access point for eight microphones.

This unit has eight female XLR connectors for microphone inputs. Phantom power can be applied independently to each of the individual inputs.

It also has one DB-25 and eight RJ-45 connectors (the DB and RJ connections are in parallel so you can choose your preferred connector type) for audio outputs. Only the first four RJ-45 ports are used. These can be set up as four stereo, eight mono, or any combination up to a maximum of eight discrete channels. These are setup as analog outputs.

Two RJ-45 connectors provide 12 logic ports, which can be individually designated during set up as inputs or outputs. Use these ports to wire the various external switches, indicators, and control functions you need in your facility.

There are two RJ-45 jacks for Ethernet. One is for 1 Gigabit Ethernet – connect this one to your network. The 100 Megabit Ethernet port is not used – do not connect anything to this port.

Consult the wiring diagram on page 1-49 for detailed information.

The unit has a standard IEC power connector. The BLADE 3s have an internal power supply that will accept 100-240 volts 50/60 hertz AC power.

IP88cb/88cbe/88cb/32cb - Console BLADE 3

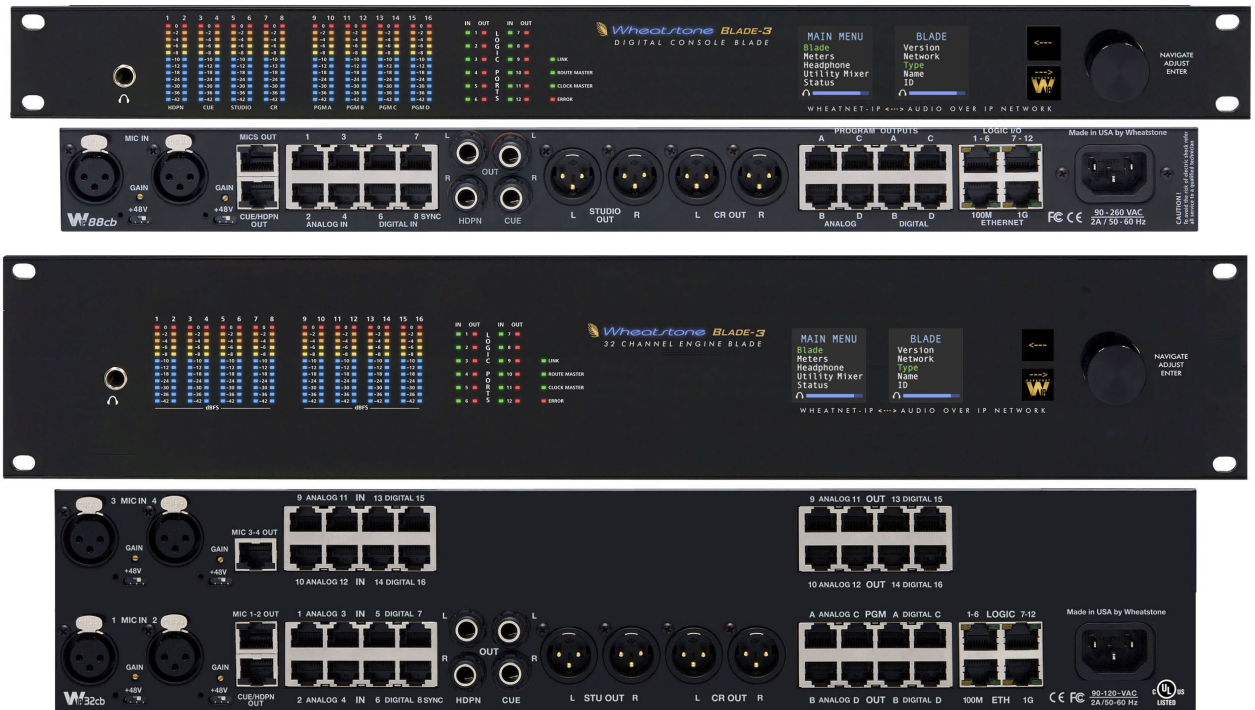

The WheatNet-IP 88cb, 88cbe, and 88cbl Console BLADE3 models provide comprehensive access points for typical control room audio I/O.

The IP 88cb Console BLADE3 comes standard with L-8, L-12, E-1, IP-12 and IP-16 control surfaces. Pairing the IP 88cbe with the E-1 control surface, the IP 88cbl with L-8 or L-12, or the IP88cb with IP-12 or IP-16 control surface, results in a super-compact, ultra powerful mix station that ties perfectly into your WheatNet-IP network or functions as a stand-alone console. A single Console BLADE3 is all that is needed for most studio operations, but busy studios often require additional I/O BLADE3s or an upgrade to Wheatstone's newer 2RU model with double the I/O. At double the I/O, the new 2RU Console BLADE3 comes with 8 AES inputs, 8 stereo analog inputs, 8 AES outputs, and 8 stereo analog outputs on StudioHub+ RJ-45s, plus 4 mic level inputs with gain trim and switchable phantom power on XLRs. 1RU Console BLADE3s are also available for the same control surfaces, and come with standard I/O (4 AES inputs, 4 stereo analog inputs, 4 AES outputs, 4 stereo analog outputs, and 2 mic level inputs). Both the 2RU and 1RU Console BLADE3 provide control room and studio stereo analog outputs on XLRs as well as cue and headphone outputs on both RJ-45 and 1/4" TRS and 12 GPI logic ports on RJ-45. Connectors description below apply to 1RU unit.

Two female XLR connectors are microphone preamplifier inputs. Recessed rear panel phantom power switches and gain trims can be independently configured, and one RJ-45 connector connects the preamp outputs to any one of the Analog Input RJ-45's.

Eight RJ-45 connectors are for audio inputs. The first four RJ-45 jacks are set up as analog inputs which can be setup as four stereo, eight mono, or any combination stereo and mono. The last four RJ-45 jacks are set up as AES digital inputs.

Console BLADE3s have eight RJ-45 connectors for audio outputs. The first four RJ-45 jacks are set up as analog stereo outputs, and the last four RJ-45 jacks are set up as AES digital outputs. The "Console" template, by default has a signal map that automatically cross connects the surfaces Program, Headphone, Cue, and Studio sources to the designated outputs. The Digital outputs follow the Analog outputs and cannot be independently connected to different audio sources.

An RJ-45 or four 1/4" jacks are provided for headphone and cue outputs.

Four XLR male connectors are provided for control room and studio outputs.

Console BLADE3s have two more RJ-45 connectors to provide 12 logic ports, which can be individually designated during set up as inputs or outputs. These ports are where you wire the various external switches, indicators, and control functions you need in your facility.

There are two RJ-45 jacks for Ethernet. One is for 1 Gigabit Ethernet – connect this one to your network. The 100 Megabit Ethernet port is not used – do not connect anything to this port.

Consult the wiring diagram on page 1-50 for detailed information.

The unit has a standard IEC power connector. The BLADE3s have an internal power supply that will accept 100-240 volts 50/60 hertz AC power.



When using the microphone preamplifiers, a jumper must be connected from the MIC OUTS to the desired analog input port (1-4).

IP 88e - Mix Engine BLADE 3



WheatNet-IP 88e is a special device that contains the mix engine and signal processing needed for a control surface. One WheatNet-IP 88e is needed for each control surface.

As you can see, it has no connections for audio inputs or outputs.

It has two RJ-45 connectors to provide 12 logic ports, which can be individually designated during set up as inputs or outputs. These ports are where you wire the various external switches, indicators, and control functions you need in your facility.

There are two RJ-45 jacks for Ethernet. One is for 1 Gigabit Ethernet – connect this one to your network. The 100 Megabit Ethernet port is not used – do not connect anything to this port.

Consult the wiring diagram at the page 1-51 for detailed information.

The unit has a standard IEC power connector. The BLADE 3s have an internal power supply that will accept 100-240 volts 50/60 hertz AC power.

As for the control surfaces, there are a variety of models (E-1, E-4, E-5, E-6) and sizes (from as few as 4 to as many as 28 faders) to choose from. These look like traditional audio consoles and perform similar kinds of functions and more. Consult the specific control surface manual for detailed information.

IP 88lxe - LXE Mix Engine BLADE 3



WheatNet-IP 88lxe is a special device that contains the mix engine and signal processing needed for a LXE control surface. One WheatNet-IP 88lxe is needed for each control surface.

As you can see, it has no connections for audio inputs or outputs.

It has two RJ-45 connectors to provide 12 logic ports, which can be individually designated during set up as inputs or outputs. These ports are where you wire the various external switches, indicators, and control functions you need in your facility.

There are three RJ-45 jacks for Ethernet. Two are for 1 Gigabit Ethernet – connect these to your network. The 100 Megabit Ethernet port is not used – do not connect anything to this port.

The HDMI port and one of the two USB connectors are for touchscreen monitor connection. The other USB connector is for mouse connection.

Consult the wiring diagram at the page 1-51 for detailed information.

The unit has a standard IEC power connector. The BLADE3s have an internal power supply that will accept 100-240 volts 50/60 hertz AC power.

As for the control surfaces, there are a variety of sizes to choose from. These look like traditional audio consoles and perform similar kinds of functions and more. Consult the LXE control surface manual for detailed information.

Aura8ip - Vorsis Embedded BLADE 3



The WheatNet-IP Aura8ip Audio Processing BLADE 3 brings two of Wheatstone's core technologies together (Vorsis Audio Processing and the WheatNet-IP Intelligent Network) to provide a convenient and cost effective way to bring access to audio processing wherever you need it on your WheatNet-IP network.

The Aura8ip BLADE 3 occupies a single rack space, but packs an impressive complement of eight fully independent Vorsis Embedded multi-band stereo audio processors. Refer to the *Aura8ip Vorsis Embedded Processing BLADE 3 Technical Manual* for audio processor description and configuration.

This BLADE 3 has two DB-25 and eight RJ-45 connectors (the DB and RJ connections are in parallel so you can choose your preferred connector type) for audio inputs. The first DB-25 and the first four RJ-45 jacks are set up as analog inputs. The second DB-25 and the last four RJ-45 jacks are set up as AES digital inputs.

The BLADE 3 also has two DB-25 and eight RJ-45 connectors (again, use your preferred connector) for audio outputs. The first DB-25 and first four RJ-45 jacks are set up as analog outputs. The second DB-25 and the last four RJ-45 jacks are set up as AES digital outputs.

The BLADE 3 has two more RJ-45 connectors to provide 12 logic ports, which can be individually designated during set up as inputs or outputs. These ports are where you wire the various external switches, indicators, and control functions you need in your facility.

There are two RJ-45 jacks for Ethernet. One is for 1 Gigabit Ethernet – connect this one to your network. The 100 Megabit Ethernet port is not used – do not connect anything to this port.

Consult the wiring diagram on page 1-52 for detailed information.

The unit has a standard IEC power connector. The BLADE 3s have an internal power supply that will accept 100-240 volts 50/60 hertz AC power.

Signal Configuration

The Aura8ip BLADE 3 can be operated as a stand alone unit, or can be operated as part of a larger WheatNet-IP network.

If the Stand alone option is selected when the BLADE 3 is configured, the rear panel inputs and outputs are automatically configured to provide the required connections to the eight channels of audio processing. Line 1 Input feeds signal to the first channel of audio processing, Line 2 Input feeds signal to the second channel, and so on. Likewise, Line 1 Output provides the output connection for the first channel of processing, Line 2 Output

for the second channel, and so on. In this mode, all inputs and outputs are configured as stereo signals. Thus, in Stand alone mode, the Aura8ip BLADE 3 functions as eight independent channels of stereo audio processing, four with analog inputs and outputs, and the other four with digital inputs and outputs.

If the Mono, Stereo, or Custom template is selected when the BLADE 3 is configured, the eight channels of audio processing are divorced from the unit's input and output connections, and these inputs and outputs can then be routed to other BLADE 3s in the system. In this Networked mode the inputs of the eight audio processing channels become destinations in the system, to which any available sources in the system can be routed. Likewise, the outputs of the eight audio processing channels become sources in the system, and may be routed to any available destinations.

Also in this Networked mode, signals wired to the BLADE 3's input connections become sources in the system and can be freely routed to any available destinations, which can include the processing channel inputs if desired. Meanwhile, the BLADE 3's output connections become destinations to which any available system sources can be routed, including the processing channel outputs, if so desired.

In the Networked mode the BLADE 3's inputs and outputs can be configured as mono, stereo, or any combination of mono and stereo required. Whether in Networked or Stand alone mode the audio processing channels are always stereo in and out.

MADI - Multichannel Audio Digital Interface BLADE

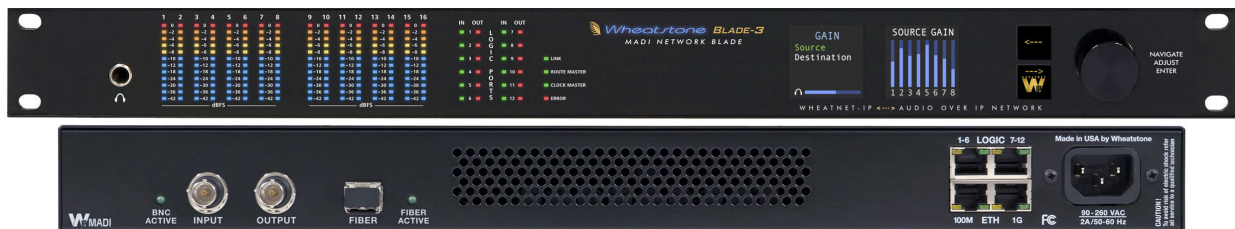

The MADI BLADE is an access point on the WheatNet-IP Intelligent Network, converting a 64-channel MADI input to data streams on the network, and converting data streams to 64-channel MADI outputs.

The MADI BLADE bridges the gap between any MADI-capable audio gear or network and the WheatNet-IP Intelligent Network. With the MADI BLADE, users can add-on to their existing infrastructure to access audio via MADI with affordable and proven WheatNet-IP equipment.

The MADI BLADE makes it possible for WheatNet-TDM Gibraltar Network users to use WheatNet-IP control surfaces and BLADE 3s with their existing networks to access up to 64 channels of audio. The added functionality and low cost of WheatNet-IP make this an exceptionally attractive offering. But its functionality is not limited to Wheatstone systems. WheatNet-IP can now put to use audio from ANY system that utilizes MADI.

The MADI BLADE supports either copper or fiber connectivity.

A pair of 75 ohm BNC connectors are provided on the rear panel and are labeled INPUT and OUTPUT. All connections should be made with a high quality 75 ohm coaxial cable terminated to male BNC connectors. By installing digital video grade coax, cable runs of 200M or more can be realized.

The MADI BLADE supports an optional fiber connection to the Bridge/Gibraltar Network Router. The MADI BLADE uses an SFP module interface with integral LC connectors. See page 1-39 for more information on the Optical Fiber Interface.

A rear panel BNC ACTIVE or FIBER ACTIVE LED will illuminate when a MADI input signal is present.

This BLADE has two RJ-45 connectors to provide 12 logic ports, which can be individually designated during set up as inputs or outputs. These ports are where you wire the various external switches, indicators, and control functions you need in your facility.

There are two RJ-45 jacks for Ethernet. One is for 1 Gigabit Ethernet – connect this one to your network. The 100 Megabit Ethernet port is not used – do not connect anything to this port.

Consult the wiring diagram on page 1-53 for detailed information.

The unit has a standard IEC power connector. The BLADEs have an internal power supply that will accept 100-240 volts 50/60 hertz AC power.

M4IP - Microphone Processing BLADE 3



The M4IP Microphone Processing BLADE 3 is the newest member of Wheatstone's WheatNet-IP Intelligent Network family. Two devices in one package, it's a complete WheatNet-IP BLADE3 with four microphone inputs, four high quality microphone processors, and both digital and analog outputs. The M4IP Microphone Processing BLADE 3 is upgraded to the M4IP-USB version with four independent USB ports built in to facilitate the individual use of USB audio devices. The four USB ports are bi-directional, providing (4) audio inputs (1 stereo input per port) from a USB audio device and (4) audio outputs (1 stereo output per port) to a USB audio device. The USB audio inputs appear as sources on the BLADE while the USB audio outputs are in parallel with the BLADE destinations 5 - 8 stereo (9 - 16 mono).

The Wheatstone M4IP hosts four discrete, very high quality microphone processors. The Vorsis Embedded™ processing features of the M4IP, the processing capabilities of the M4IP and how to control it with the included Windows-based GUI application are described in the *M4IP Microphone Processing BLADE 3* technical manual.

This unit has four XLR female connectors for microphone-level inputs.

It also has one DB-25 and eight RJ-45 connectors (the DB and analog 1-4 RJ connections are in parallel so you can choose your preferred connector type) for audio outputs.

Two RJ-45 connectors provide 12 logic ports, which can be individually designated during set up as inputs or outputs. Use these ports to wire the various external switches, indicators, and control functions you need in your facility.

There are two RJ-45 jacks for Ethernet. One is for 1 Gigabit Ethernet – connect this one to your network. The 100 Megabit Ethernet port is not used – do not connect anything to this port.

Consult the wiring diagram on page 1-54 for detailed information.

The unit has a standard IEC power connector. The BLADE3s have an internal power supply that will accept 100-240 volts 50/60 hertz AC power.

HD-SDI - Audio De-Embedder BLADE 3



The HD-SDI BLADE 3 is a specialty BLADE for extracting encapsulated audio from a serial digital interface (SDI). With the HD-SDI BLADE 3, you can ingest audio into the WheatNet-IP Intelligent Network from video production automation systems, routers, and other professional video equipment that use HD-SDI.

Our new specialty HD-SDI BLADE 3 for the WheatNet-IP Intelligent Network de-embeds multiple audio channels from HD-SDI streams so you can mix, process or simply route audio to your console for final broadcast. The HD-SDI is capable of de-embedding up to four HD-SDI streams, and up to 8 AES/EBU pairs (16 audio channels) per stream. The HD-SDI BLADE 3 has four BNC connectors for coaxial input, and includes logic control, onboard utility functions and the dedicated controller that is at the core of its intelligence. Like other BLADE 3s, the HD-SDI BLADE 3 has its own CPU and operating system and provides a 1000BaseT (Gigabit) network interface for optimum network QoS and reliability. The HD-SDI BLADE 3 is AES67 compatible for interoperability with other AES67 compatible systems and devices, and has two built-in 8x2 stereo mixers. It comes with 12 universal logic (GPIO) ports for interfacing various external switches, indicators and devices for control purposes – as well as 128 software logic ports for routing and controlling devices anywhere on the network.

The rear panel has four pairs of the BNC connectors for coaxial input and loop, and one pair to provide a DARS reference input to sync WheatNet-IP to the house DARS reference. Two RJ-45 connectors provide 12 logic ports, which can be individually designated during set up as inputs or outputs. Use these ports to wire the various external switches, indicators, and control functions you need in your facility.

There are two RJ-45 jacks for Ethernet. One is for 1 Gigabit Ethernet – connect this one to your network. The 100 Megabit Ethernet port is not used – do not connect anything to this port.

Consult the wiring diagram on page 1-55 for detailed information.

LIO-48 - Multiple Port Logic I/O BLADE



Wheatstone’s new LIO-48 is a high-density logic BLADE for the WheatNet-IP Intelligent Network that can handle all those new conditional logic functions needed for today’s busy studios. The LIO-48 provides 48 universal logic I/O ports, each individually configurable, for turning devices on or off by time or event, for automatically adjusting the audio

processing settings when a certain mic turns on, and for any other logic control you need in your studio operation.

The front panel of the LIO-48 has a logic I/O meter array that lets you drill down to see the information for each of the 48 ports. The front panel also sports a display which can show various status messages relating to the BLADE's performance and configuration. A SCROLL knob, a TAKE button, and four status indicator LEDs complete the front panel. Refer to the *LIO-48 Multiple port Logic I/O Blade Technical Manual* for front panel configuration and software setup.

The rear panel has eight RJ-45 connectors that have the connections for all 48 ports (each RJ-45 has connections for six ports). Two DB-25 female connectors duplicate the logic port connections. A DB-9 female connector provides access to +5VDC from the BLADE. Two additional RJ-45 connectors are stacked at the right side of the rear panel. The top one of there is reserved for future use, while the bottom one provides a 1 Gigabit connection to the WheatNet-IP network. At the far right of the rear panel is a standard IFC power connector. The LIO-48 has an internal power supply that will accept 100-240 Volts 50/60 Hertz AC power.

Consult the wiring diagram on page 1-56 for detailed information.

EDGE Network Interface



The Network Edge was created to support use of low cost IP radios for WheatNet-IP audio links. So why are some IP radios cheap and others very expensive? A full duplex radio used historically for STL links has the ability to transmit data simultaneously in both directions. Doing so requires that the receive amplifier must have very significant rejection of the transmitter RF, and that adds cost. Half duplex IP radios which are significantly lower cost, handshake between the two ends to decide when each will burst transmit data while the other must be in receive mode. This half duplex mechanism requires more complex control, but significantly reduces the RF TX/RX front end cost.

The half duplex scheme however creates a problem for the WheatNet-IP system that is based on the use of high speed Ethernet switches for moving small Ethernet packets with minimal latency thru the network fabric. The BLADEs ingest the small .25msec packets and only buffer a few of them before playing out the audio thereby limiting latency to less than 1 msec. For real time production, the latency for mix-minus feeds is critical to keep at a minimum. The half duplexing rate of IP radios is on the order of several milliseconds. The control scheme of radios will ingest and store many packets during one phase of the duplexing. Then this data is bursts across the link at a much higher rate and buffered up on the RX side of link. That data is then spurt out as packets onto the Ethernet network on far side. The same operation is done from far side to near side but during opposite phase of duplexing. The point here is that the IP radio creates an unpredictable dynamic latency to packets flowing across the link.

The EDGE alleviates this random latency problem by adding a buffering mechanism between the radio and the network. The EDGE can be located at *either* end of the link, but the way it operates with WheatNet-IP depends which end it is located on. For the typical STL application, the EDGE (ST_EDGE) may be located at the studio end of link and a BLADE is then located at the transmitter end. Or, the EDGE (TR_EDGE) is located at transmitter end. For both cases, the internal hardware of EDGE remains mostly the same. Small .25 msec packets are ingested, buffered and repackaged as 5 msec packets. There are 4 instances of this RX-TX mechanism which we have denoted as BIG for signal name defaults.

The EDGE may be installed at either the Studio or Transmitter sides of the IP-STL link. Where you decide to install it depends on a few factors: IP Radio, BLADE infrastructure, and cost.

The front panel of the EGDE houses 8-segment, multi-color LEDs for metering a streaming audio and inputs or outputs as 4 pairs signals. The front panel also sports an OLED display which can show various status messages relating to the EDGE's performance and configuration. The front panel display, button, and knob quickly and easily allow you to set up and configure each EDGE. Pressing the button takes you to the main menu, or backs out to the previous display. Rotation of the knob navigates up and down a menu when there is a list, or scrolls through options in a submenu once one has been selected. Pushing the knob "takes" an option.

A headphone jack on left side complete the front panel.

The EDGE provides two stereo analog inputs and two stereo analog outputs on XLR connectors. A pair of AES inputs and a pair of AES outputs are also available on RJ-45 connectors. These inputs are fed through a fixed 100mS buffer and available in Navigator as Sources.

In a Studio EDGE installation, the analog and AES I/O may not be required.

In a Transmitter EDGE installation, Analog or AES outputs would be utilized to feed an air chain, while the analog or AES inputs may be used for return path audio.

The Network EDGE is provides 12 programmable logic ports.

Consult the wiring diagram on page 1-57 for detailed information.

At the far right of the rear panel is a standard IFC power connector. The EDGE has an internal power supply that will accept 100-240 Volts 50/60 Hertz AC power.

Refer to the *Edge Network Interface* Technical Manual for description and configuration details.

Network Switches

The next component of the WheatNet-IP system is your network switch(es). These are standard Ethernet devices that form the core of your LAN. You may already have a suitable one in place in your facility. There are literally hundreds of different models available in the market place which vary widely in size and capability, costing anywhere from \$30 to \$30,000 and up. Obviously the \$30,000 switch has more features and capability than the \$30 switch. The important thing to remember is that most Gigabit switches will work with WheatNet-IP – up to a point. As the size of your system increases, it's easy to exceed the capability of inexpensive switches. Large systems need high capacity managed switches to avoid the bane of Ethernet audio systems, network overload. Simply put, if the WheatNet-IP devices are streaming packets faster than the Ethernet switch can distribute them,

packets get dropped and the audio starts to break up. This is why your Ethernet switches must be sized appropriately, and your network traffic managed and controlled so that the sizing assumptions you made remain valid. Because 24 bit 48K sample rate audio streams represent a much larger packet rate than Ethernet networks were originally assumed to contain, they can represent the vast majority of data in the network. Consequently just about any switch or link can get overloaded if you are streaming lots of channels and don't attempt to manage your network and switch configuration. Consult the Chapter 4 *Ethernet Network and Switches* for more information about switches, or call us at Wheatstone Corporation for help with switch recommendations.

CAT5e/CAT6 Wiring

The next component of your WheatNet-IP system is the CAT5e or CAT6 wiring itself. Each BLADE 3 requires a single 1 Gigabit network connection, which is typically a CAT5e or CAT6 cable. Due to the nature of Ethernet and CAT6 cabling, these connections must be at least 1 meter but less than 100 meters in length. If you must connect devices together that are more than 100 meters apart, use an interim Ethernet “edge” switch, or else use optical fiber and copper/fiber convertors to extend the range of the Ethernet LAN connections.

AoIP Driver

The next component of your system is the WheatNet-IP AoIP driver. This is software that will allow any Windows 2000 or XP device to send and receive audio packets as a member of the WheatNet-IP system. Typically, this driver would be installed on your Automation PCs to allow them to play back audio into the WheatNet-IP system without using a sound card. You can install the driver on any PC that you wish to get audio to/from. On a modern PC, the driver will allow up to eight different audio streams playing back simultaneously while accepting eight different audio input streams. That's a lot of audio, representing over half of the total bandwidth available on the standard 100 Mbit Ethernet NIC card installed in most PCs. Please note that any PC can use the WheatNet-IP AoIP driver; it doesn't need to be an Automation server. If you want to stream your station's Program output to the PD's office PC, you can. Likewise, many modern audio devices such as codecs are really PCs at heart. If they are running Windows and can work with standard WDM drivers, they can most likely be directly connected to the WheatNet-IP system.

Software Tool

The next component of your WheatNet-IPs system is the software tool used to administer it. While the WheatNet-IP system is completely functional (unlike some competitors) without running any software on a PC, you will find the Navigator GUI program very handy for administrating normal system functions like setting access passwords, controlling signal visibilities, naming sources and destinations, etc. Navigator described later in this manual.

Audio Devices

Lastly are your audio devices themselves. Your loudspeakers and headphone amps, your microphones, CD players, and Sat receivers, your processors and codecs. These are the devices you've created your audio network for. Wire them up to the appropriate “BLADE3” and they have instant access to all of the audio in your system. Connecting any source to any destination is just a simple “click” away.

I/O Connections

All audio input and output, control, Ethernet, and power supply connections are made via DB-25, RJ-45, XLR, BNC connectors, and 1/4" jacks mounted on the WheatNet-IP rear panel. The pinout drawings on pages 1-46 through 1-57 summarize all wiring connections.

Model IP 88a



INPUTS

The WheatNet-IP 88a is fed from analog line level inputs via two DB-25 or eight RJ-45 connectors.

The line level analog audio inputs are +4dBu balanced. The analog line inputs exhibit a bridging impedance and can handle signals up to +20dBu.

Analog 1-4 DB-25

Pin 24 – HI	}	Line 1 Lt In
Pin 12 – LO		
Pin 25 – SH		
Pin 10 – HI	}	Line 1 Rt In
Pin 23 – LO		
Pin 11 – SH		
Pin 21 – HI	}	Line 2 Lt In
Pin 9 – LO		
Pin 22 – SH		
Pin 7 – HI	}	Line 2 Rt In
Pin 20 – LO		
Pin 8 – SH		
Pin 18 – HI	}	Line 3 Lt In
Pin 6 – LO		
Pin 19 – SH		
Pin 4 – HI	}	Line 3 Rt In
Pin 17 – LO		
Pin 5 – SH		
Pin 15 – HI	}	Line 4 Lt In
Pin 3 – LO		
Pin 16 – SH		
Pin 1 – HI	}	Line 4 Rt In
Pin 14 – LO		
Pin 2 – SH		

Analog 5-8 DB-25

Pin 24 – HI]	Line 5 Lt In
Pin 12 – LO		
Pin 25 – SH		
Pin 10 – HI]	Line 5 Rt In
Pin 23 – LO		
Pin 11 – SH		
Pin 21 – HI]	Line 6 Lt In
Pin 9 – LO		
Pin 22 – SH		
Pin 7 – HI]	Line 6 Rt In
Pin 20 – LO		
Pin 8 – SH		
Pin 18 – HI]	Line 7 Lt In
Pin 6 – LO		
Pin 19 – SH		
Pin 4 – HI]	Line 7 Rt In
Pin 17 – LO		
Pin 5 – SH		
Pin 15 – HI]	Line 8 Lt In
Pin 3 – LO		
Pin 16 – SH		
Pin 1 – HI]	Line 8 RT In
Pin 14 – LO		
Pin 2 – SH		

Analog 1-8 RJ-45

RJ-45#1 Pin 1 – HI]	Line 1 Lt In
RJ-45#1 Pin 2 – LO		
RJ-45#1 Pin 3 – HI]	Line 1 Rt In
RJ-45#1 Pin 6 – LO		
RJ-45#2 Pin 1 – HI]	Line 2 Lt In
RJ-45#2 Pin 2 – LO		
RJ-45#2 Pin 3 – HI]	Line 2 Rt In
RJ-45#2 Pin 6 – LO		
RJ-45#3 Pin 1 – HI]	Line 3 Lt In
RJ-45#3 Pin 2 – LO		
RJ-45#3 Pin 3 – HI]	Line 3 Rt In
RJ-45#3 Pin 6 – LO		
RJ-45#4 Pin 1 – HI]	Line 4 Lt In
RJ-45#4 Pin 2 – LO		
RJ-45#4 Pin 3 – HI]	Line 4 Rt In
RJ-45#4 Pin 6 – LO		
RJ-45#5 Pin 1 – HI]	Line 5 Lt In
RJ-45#5 Pin 2 – LO		
RJ-45#5 Pin 3 – HI]	Line 5 Rt In
RJ-45#5 Pin 6 – LO		
RJ-45#6 Pin 1 – HI]	Line 6 Lt In
RJ-45#6 Pin 2 – LO		
RJ-45#6 Pin 3 – HI]	Line 6 Rt In
RJ-45#6 Pin 6 – LO		

RJ-45#7 Pin 1 – HI]	Line 7 Lt In
RJ-45#7 Pin 2 – LO		
RJ-45#7 Pin 3 – HI]	Line 7 Rt In
RJ-45#7 Pin 6 – LO		
RJ-45#8 Pin 1 – HI]	Line 8 Lt In
RJ-45#8 Pin 2 – LO		
RJ-45#8 Pin 3 – HI]	Line 8 Rt In
RJ-45#8 Pin 6 – LO		

OUTPUTS

The line level analog output signal is +4dBu, balanced.

Analog 1-4 DB-25

Pin 24 – HI]	Line 1 Lt Out
Pin 12 – LO		
Pin 25 – SH		
Pin 10 – HI]	Line 1 Rt Out
Pin 23 – LO		
Pin 11 – SH		
Pin 21 – HI]	Line 2 Lt Out
Pin 9 – LO		
Pin 22 – SH		
Pin 7 – HI]	Line 2 Rt Out
Pin 20 – LO		
Pin 8 – SH		
Pin 18 – HI]	Line 3 Lt Out
Pin 6 – LO		
Pin 19 – SH		
Pin 4 – HI]	Line 3 Rt Out
Pin 17 – LO		
Pin 5 – SH		
Pin 15 – HI]	Line 4 Lt Out
Pin 3 – LO		
Pin 16 – SH		
Pin 1 – HI]	Line 4 Rt Out
Pin 14 – LO		
Pin 2 – SH		

Analog 5-8 DB-25

Pin 24 – HI]	Line 5 Lt Out
Pin 12 – LO		
Pin 25 – SH		
Pin 10 – HI]	Line 5 Rt Out
Pin 23 – LO		
Pin 11 – SH		
Pin 21 – HI]	Line 6 Lt Out
Pin 9 – LO		
Pin 22 – SH		

Pin 7 – HI	}	Line 6 Rt Out
Pin 20 – LO		
Pin 8 – SH		
Pin 18 – HI	}	Line 7 Lt Out
Pin 6 – LO		
Pin 19 – SH		
Pin 4 – HI	}	Line 7 Rt Out
Pin 17 – LO		
Pin 5 – SH		
Pin 15 – HI	}	Line 8 Lt Out
Pin 3 – LO		
Pin 16 – SH		
Pin 1 – HI	}	Line 8 Rt Out
Pin 14 – LO		
Pin 2 – SH		

Analog 1-8 RJ-45

RJ-45#1 Pin 1 – HI	}	Line 1 Lt Out
RJ-45#1 Pin 2 – LO		
RJ-45#1 Pin 3 – HI	}	Line 1 Rt Out
RJ-45#1 Pin 6 – LO		
RJ-45#2 Pin 1 – HI	}	Line 2 Lt Out
RJ-45#2 Pin 2 – LO		
RJ-45#2 Pin 3 – HI	}	Line 2 Rt Out
RJ-45#2 Pin 6 – LO		
RJ-45#3 Pin 1 – HI	}	Line 3 Lt Out
RJ-45#3 Pin 2 – LO		
RJ-45#3 Pin 3 – HI	}	Line 3 Rt Out
RJ-45#3 Pin 6 – LO		
RJ-45#4 Pin 1 – HI	}	Line 4 Lt Out
RJ-45#4 Pin 2 – LO		
RJ-45#4 Pin 3 – HI	}	Line 4 Rt Out
RJ-45#4 Pin 6 – LO		
RJ-45#5 Pin 1 – HI	}	Line 5 Lt Out
RJ-45#5 Pin 2 – LO		
RJ-45#5 Pin 3 – HI	}	Line 5 Rt Out
RJ-45#5 Pin 6 – LO		
RJ-45#6 Pin 1 – HI	}	Line 6 Lt Out
RJ-45#6 Pin 2 – LO		
RJ-45#6 Pin 3 – HI	}	Line 6 Rt Out
RJ-45#6 Pin 6 – LO		
RJ-45#7 Pin 1 – HI	}	Line 7 Lt Out
RJ-45#7 Pin 2 – LO		
RJ-45#7 Pin 3 – HI	}	Line 7 Rt Out
RJ-45#7 Pin 6 – LO		
RJ-45#8 Pin 1 – HI	}	Line 8 Lt Out
RJ-45#8 Pin 2 – LO		
RJ-45#8 Pin 3 – HI	}	Line 8 Rt Out
RJ-45#8 Pin 6 – LO		

Model IP 88d



INPUTS

The WheatNet-IP 88d is fed from digital inputs via two DB-25 or eight RJ-45 connectors.

The WheatNet-IP 88d will accommodate digital inputs having a wide range of sample rates. These inputs will be sample rate converted to the system's chosen sample rate of 44.1kHz or 48kHz, which is set via the WheatNet-IP Navigator GUI. The GUI also allows you to select input 8 of the digital BLADE 3, or of any BLADE3 that has a digital input as input 8, to be a primary external reference, and a digital input 8 from a different BLADE3 to be a secondary external reference. Please note that the sample rate of a digital input 8 should be the same, either 44.1kHz or 48kHz, as the system's chosen sample rate.

AES sources are by design stereo; if the BLADE 3 is not set to be stereo the appropriate Left or Right signal within the AES stream will be applied to the signal path.

Digital 1-4 DB-25

Pin 24 – HI	}	AES 1 In
Pin 12 – LO		
Pin 25 – SH		
Pin 21 – HI	}	AES 2 In
Pin 9 – LO		
Pin 22 – SH		
Pin 18 – HI	}	AES 3 In
Pin 6 – LO		
Pin 19 – SH		
Pin 15 – HI	}	AES 4 In
Pin 3 – LO		
Pin 16 – SH		

Digital 5-8 DB-25

Pin 24 – HI	}	AES 5 In
Pin 12 – LO		
Pin 25 – SH		
Pin 21 – HI	}	AES 6 In
Pin 9 – LO		
Pin 22 – SH		
Pin 18 – HI	}	AES 7 In
Pin 6 – LO		
Pin 19 – SH		
Pin 15 – HI	}	AES 8 In
Pin 3 – LO		
Pin 16 – SH		

Digital 1-8 RJ-45

RJ-45#1 Pin 1 – HI]	AES 1 In
RJ-45#1 Pin 2 – LO		
RJ-45#2 Pin 1 – HI]	AES 2 In
RJ-45#2 Pin 2 – LO		
RJ-45#3 Pin 1 – HI]	AES 3 In
RJ-45#3 Pin 2 – LO		
RJ-45#4 Pin 1 – HI]	AES 4 In
RJ-45#4 Pin 2 – LO		
RJ-45#5 Pin 1 – HI]	AES 5 In
RJ-45#5 Pin 2 – LO		
RJ-45#6 Pin 1 – HI]	AES 6 In
RJ-45#6 Pin 2 – LO		
RJ-45#7 Pin 1 – HI]	AES 7 In
RJ-45#7 Pin 2 – LO		
RJ-45#8 Pin 1 – HI]	AES 8 In
RJ-45#8 Pin 2 – LO		

OUTPUTS**Digital 1-4 DB-25**

Pin 24 – HI]	AES 1 Out
Pin 12 – LO		
Pin 25 – SH		
Pin 21 – HI]	AES 2 Out
Pin 9 – LO		
Pin 22 – SH		
Pin 18 – HI]	AES 3 Out
Pin 6 – LO		
Pin 19 – SH		
Pin 15 – HI]	AES 4 Out
Pin 3 – LO		
Pin 16 – SH		

Digital 5-8 DB-25

Pin 24 – HI]	AES 5 Out
Pin 12 – LO		
Pin 25 – SH		
Pin 21 – HI]	AES 6 Out
Pin 9 – LO		
Pin 22 – SH		
Pin 18 – HI]	AES 7 Out
Pin 6 – LO		
Pin 19 – SH		
Pin 15 – HI]	AES 8 Out
Pin 3 – LO		
Pin 16 – SH		

Digital 1-8 RJ-45

RJ-45#1 Pin 1 – HI]	AES 1 Out
RJ-45#1 Pin 2 – LO		
RJ-45#2 Pin 1 – HI]	AES 2 Out
RJ-45#2 Pin 2 – LO		
RJ-45#3 Pin 1 – HI]	AES 3 Out
RJ-45#3 Pin 2 – LO		
RJ-45#4 Pin 1 – HI]	AES 4 Out
RJ-45#4 Pin 2 – LO		
RJ-45#5 Pin 1 – HI]	AES 5 Out
RJ-45#5 Pin 2 – LO		
RJ-45#6 Pin 1 – HI]	AES 6 Out
RJ-45#6 Pin 2 – LO		
RJ-45#7 Pin 1 – HI]	AES 7 Out
RJ-45#7 Pin 2 – LO		
RJ-45#8 Pin 1 – HI]	AES 8 Out
RJ-45#8 Pin 2 – LO		

Model IP 88ad**INPUTS**

The WheatNet-IP 88ad is fed from a combination of analog and digital inputs via two DB-25 or eight RJ-45 connectors.

The digital inputs of the WheatNet-IP 88ad (inputs 5-8) will accommodate digital inputs having a wide range of sample rates. These inputs will be sample rate converted to the system's chosen sample rate of 44.1kHz or 48kHz, which is set via the WheatNet-IP Navigator GUI. The GUI also allows you to select input 8 of the digital BLADE 3, or of any BLADE 3 that has a digital input as input 8, to be a primary external reference, and a digital input 8 from a different BLADE 3 to be a secondary external reference. Please note that the sample rate of a digital input 8 should be the same, either 44.1kHz or 48kHz, as the system's chosen sample rate.

AES sources are by design stereo; if the BLADE 3 is not set to be stereo the appropriate Left or Right signal within the AES stream will be applied to the signal path.

Analog 1-4 DB-25

Pin 24 – HI]	Line 1 Lt In
Pin 12 – LO		
Pin 25 – SH		
Pin 10 – HI]	Line 1 Rt In
Pin 23 – LO		
Pin 11 – SH		

Pin 21 – HI]	Line 2 Lt In
Pin 9 – LO		
Pin 22 – SH		
Pin 7 – HI]	Line 2 Rt In
Pin 20 – LO		
Pin 8 – SH		
Pin 18 – HI]	Line 3 Lt In
Pin 6 – LO		
Pin 19 – SH		
Pin 4 – HI]	Line 3 Rt In
Pin 17 – LO		
Pin 5 – SH		
Pin 15 – HI]	Line 4 Lt In
Pin 3 – LO		
Pin 16 – SH		
Pin 1 – HI]	Line 4 Rt In
Pin 14 – LO		
Pin 2 – SH		

Digital 5-8 DB-25

Pin 24 – HI]	AES 5 In
Pin 12 – LO		
Pin 25 – SH		
Pin 21 – HI]	AES 6 In
Pin 9 – LO		
Pin 22 – SH		
Pin 18 – HI]	AES 7 In
Pin 6 – LO		
Pin 19 – SH		
Pin 15 – HI]	AES 8 In
Pin 3 – LO		
Pin 16 – SH		

Analog 1-4 RJ-45

RJ-45#1 Pin 1 – HI]	Line 1 Lt In
RJ-45#1 Pin 2 – LO		
RJ-45#1 Pin 3 – HI]	Line 1 Rt In
RJ-45#1 Pin 6 – LO		
RJ-45#2 Pin 1 – HI]	Line 2 Lt In
RJ-45#2 Pin 2 – LO		
RJ-45#2 Pin 3 – HI]	Line 2 Rt In
RJ-45#2 Pin 6 – LO		
RJ-45#3 Pin 1 – HI]	Line 3 Lt In
RJ-45#3 Pin 2 – LO		
RJ-45#3 Pin 3 – HI]	Line 3 Rt In
RJ-45#3 Pin 6 – LO		
RJ-45#4 Pin 1 – HI]	Line 4 Lt In
RJ-45#4 Pin 2 – LO		
RJ-45#4 Pin 3 – HI]	Line 4 Rt In
RJ-45#4 Pin 6 – LO		

Digital 5-8 RJ-45

RJ-45#5 Pin 1 – HI]	AES 5 In
RJ-45#5 Pin 2 – LO		
RJ-45#6 Pin 1 – HI]	AES 6 In
RJ-45#6 Pin 2 – LO		
RJ-45#7 Pin 1 – HI]	AES 7 In
RJ-45#7 Pin 2 – LO		
RJ-45#8 Pin 1 – HI]	AES 8 In
RJ-45#8 Pin 2 – LO		

OUTPUTS**Analog 1-4 DB-25**

Pin 24 – HI]	Line 1 Lt Out
Pin 12 – LO		
Pin 25 – SH		
Pin 10 – HI]	Line 1 Rt Out
Pin 23 – LO		
Pin 11 – SH		
Pin 21 – HI]	Line 2 Lt Out
Pin 9 – LO		
Pin 22 – SH		
Pin 7 – HI]	Line 2 Rt Out
Pin 20 – LO		
Pin 8 – SH		
Pin 18 – HI]	Line 3 Lt Out
Pin 6 – LO		
Pin 19 – SH		
Pin 4 – HI]	Line 3 Rt Out
Pin 17 – LO		
Pin 5 – SH		
Pin 15 – HI]	Line 4 Lt Out
Pin 3 – LO		
Pin 16 – SH		
Pin 1 – HI]	Line 4 Rt Out
Pin 14 – LO		
Pin 2 – SH		

Digital 5-8 DB-25

Pin 24 – HI]	AES 5 Out
Pin 12 – LO		
Pin 25 – SH		
Pin 21 – HI]	AES 6 Out
Pin 9 – LO		
Pin 22 – SH		
Pin 18 – HI]	AES 7 Out
Pin 6 – LO		
Pin 19 – SH		
Pin 15 – HI]	AES 8 Out
Pin 3 – LO		
Pin 16 – SH		

Analog 1-4 RJ-45

RJ-45#1 Pin 1 – HI	}	Line 1 Lt Out
RJ-45#1 Pin 2 – LO		
RJ-45#1 Pin 3 – HI	}	Line 1 Rt Out
RJ-45#1 Pin 6 – LO		
RJ-45#2 Pin 1 – HI	}	Line 2 Lt Out
RJ-45#2 Pin 2 – LO		
RJ-45#2 Pin 3 – HI	}	Line 2 Rt Out
RJ-45#2 Pin 6 – LO		
RJ-45#3 Pin 1 – HI	}	Line 3 Lt Out
RJ-45#3 Pin 2 – LO		
RJ-45#3 Pin 3 – HI	}	Line 3 Rt Out
RJ-45#3 Pin 6 – LO		
RJ-45#4 Pin 1 – HI	}	Line 4 Lt Out
RJ-45#4 Pin 2 – LO		
RJ-45#4 Pin 3 – HI	}	Line 4 Rt Out
RJ-45#4 Pin 6 – LO		

Digital 5-8 RJ-45

RJ-45#5 Pin 1 – HI	}	AES 5 Out
RJ-45#5 Pin 2 – LO		
RJ-45#6 Pin 1 – HI	}	AES 6 Out
RJ-45#6 Pin 2 – LO		
RJ-45#7 Pin 1 – HI	}	AES 7 Out
RJ-45#7 Pin 2 – LO		
RJ-45#8 Pin 1 – HI	}	AES 8 Out
RJ-45#8 Pin 2 – LO		

Model IP 88m**INPUTS**

The WheatNet-IP 88m analog mono mic level input (-50dBu nominal) is fed from the female XLR connector to the internal microphone preamplifier. The mic preamp has digitally controlled gain, up to a maximum of 70 dB, and displays remarkably high performance and accuracy. Phantom power is available.

Analog 1-8 XLR

XLR#1 Pin 1 – SH	}	Mic 1 In
XLR#1 Pin 2 – HI		
XLR#1 Pin 3 – LO		
XLR#2 Pin 1 – SH	}	Mic 2 In
XLR#2 Pin 2 – HI		
XLR#2 Pin 3 – LO		
XLR#3 Pin 1 – SH	}	Mic 3 In
XLR#3 Pin 2 – HI		
XLR#3 Pin 3 – LO		

XLR#4 Pin 1 – SH	}	Mic 4 In
XLR#4 Pin 2 – HI		
XLR#4 Pin 3 – LO		
XLR#5 Pin 1 – SH	}	Mic 5 In
XLR#5 Pin 2 – HI		
XLR#5 Pin 3 – LO		
XLR#6 Pin 1 – SH	}	Mic 6 In
XLR#6 Pin 2 – HI		
XLR#6 Pin 3 – LO		
XLR#7 Pin 1 – SH	}	Mic 7 In
XLR#7 Pin 2 – HI		
XLR#7 Pin 3 – LO		
XLR#8 Pin 1 – SH	}	Mic 8 In
XLR#8 Pin 2 – HI		
XLR#8 Pin 3 – LO		

OUTPUTS

The output signals are available as analog line level (+4dBu, balanced) or mono mic level (-50dBu) on the DB-25 connector, or on the four RJ-45 (#1 through #4) connectors.

Analog 1-4 DB-25

Pin 24 – HI	}	Line 1 Lt Out
Pin 12 – LO		
Pin 25 – SH		
Pin 10 – HI	}	Line 1 Rt Out
Pin 23 – LO		
Pin 11 – SH		
Pin 21 – HI	}	Line 2 Lt Out
Pin 9 – LO		
Pin 22 – SH		
Pin 7 – HI	}	Line 2 Rt Out
Pin 20 – LO		
Pin 8 – SH		
Pin 18 – HI	}	Line 3 Lt Out
Pin 6 – LO		
Pin 19 – SH		
Pin 4 – HI	}	Line 3 Rt Out
Pin 17 – LO		
Pin 5 – SH		
Pin 15 – HI	}	Line 4 Lt Out
Pin 3 – LO		
Pin 16 – SH		
Pin 1 – HI	}	Line 4 Rt Out
Pin 14 – LO		
Pin 2 – SH		

Analog 1-8 RJ-45

RJ-45#1 Pin 1 – HI	}	Line 1 Lt Out
RJ-45#1 Pin 2 – LO		
RJ-45#1 Pin 3 – HI	}	Line 1 Rt Out
RJ-45#1 Pin 6 – LO		

RJ-45#2 Pin 1 – HI	}	Line 2 Lt Out
RJ-45#2 Pin 2 – LO		
RJ-45#2 Pin 3 – HI	}	Line 2 Rt Out
RJ-45#2 Pin 6 – LO		
RJ-45#3 Pin 1 – HI	}	Line 3 Lt Out
RJ-45#3 Pin 2 – LO		
RJ-45#3 Pin 3 – HI	}	Line 3 Rt Out
RJ-45#3 Pin 6 – LO		
RJ-45#4 Pin 1 – HI	}	Line 4 Lt Out
RJ-45#4 Pin 2 – LO		
RJ-45#4 Pin 3 – HI	}	Line 4 Rt Out
RJ-45#4 Pin 6 – LO		

Model IP 88cb/88cbe/88cbl



INPUTS

The WheatNet-IP 88cb, 88cbe, and 88cbl console BLADE 3s can be fed from three different types of inputs: microphone, analog line level, and AES-3 digital.

When processing mic level (-50dBu nominal) inputs, the input to the internal microphone preamplifiers is fed from one of the two female XLR connectors. When using the internal microphone preamplifiers, a jumper must be connected from the MIC OUTS RJ-45 to a selected Analog input (1-4). The mic preamp has digitally controlled gain, up to a maximum of 70dB, and displays remarkably high performance and accuracy. Phantom power is available via recessed rear panel switches.

Four RJ-45 connectors can be used for analog line level inputs. The line level analog audio inputs are +4dBu balanced. The analog line inputs exhibit a bridging impedance and can handle signals up to +20dBu.

To handle digital line level sources there are also four RJ-45 connectors.

The digital inputs of the WheatNet-IP 88cb, 88cbe, and 88cbl (inputs 5-8) will accommodate digital inputs having a wide range of sample rates. These inputs will be sample rate converted to the system's chosen sample rate of 44.1kHz or 48kHz, which is set via the WheatNet-IP Navigator GUI. The GUI also allows you to select input 8 of the digital BLADE 3, or of any BLADE 3 that has a digital input as input 8, to be a primary external reference, and a digital input 8 from a different BLADE 3 to be a secondary external reference. Please note that the sample rate of a digital input 8 should be the same, either 44.1kHz or 48kHz, as the system's chosen sample rate.

AES sources are by design stereo; if the BLADE 3 is not set to be stereo the appropriate Left or Right signal within the AES stream will be applied to the signal path.

MIC IN XLR

XLR#1 Pin 1 – SH	}	Mic 1 In
XLR#1 Pin 2 – HI		
XLR#1 Pin 3 – LO		

XLR#2 Pin 1 – SH	}	Mic 2 In
XLR#2 Pin 2 – HI		
XLR#2 Pin 3 – LO		

Analog 1-4 RJ-45

RJ-45#1 Pin 1 – HI	}	Line 1 Lt In
RJ-45#1 Pin 2 – LO		
RJ-45#1 Pin 3 – HI	}	Line 1 Rt In
RJ-45#1 Pin 6 – LO		
RJ-45#2 Pin 1 – HI	}	Line 2 Lt In
RJ-45#2 Pin 2 – LO		
RJ-45#2 Pin 3 – HI	}	Line 2 Rt In
RJ-45#2 Pin 6 – LO		
RJ-45#3 Pin 1 – HI	}	Line 3 Lt In
RJ-45#3 Pin 2 – LO		
RJ-45#3 Pin 3 – HI	}	Line 3 Rt In
RJ-45#3 Pin 6 – LO		
RJ-45#4 Pin 1 – HI	}	Line 4 Lt In
RJ-45#4 Pin 2 – LO		
RJ-45#4 Pin 3 – HI	}	Line 4 Rt In
RJ-45#4 Pin 6 – LO		

Digital 5-8 RJ-45

RJ-45#5 Pin 1 – HI	}	AES 5 In
RJ-45#5 Pin 2 – LO		
RJ-45#6 Pin 1 – HI	}	AES 6 In
RJ-45#6 Pin 2 – LO		
RJ-45#7 Pin 1 – HI	}	AES 7 In
RJ-45#7 Pin 2 – LO		
RJ-45#8 Pin 1 – HI	}	AES 8 In
RJ-45#8 Pin 2 – LO		

OUTPUTS

The WheatNet-IP 88cb, 88cbe, and 88cbl provide four stereo analog outputs on RJ-45 connectors, four digital AES formatted outputs on RJ-45 connectors, cue and headphone outputs on RJ-45 connector and on 1/4" jacks, and control room and studio monitor outputs on XLR male connectors.

MIC OUTS RJ-45

RJ-45 Pin 1 – HI	}	Mic 1 Out
RJ-45 Pin 2 – LO		
RJ-45 Pin 3 – HI	}	Mic 2 Out
RJ-45 Pin 6 – LO		



When using the microphone preamplifiers, a jumper must be connected from the MIC OUTS to the desired analog input port (1-4).

CUE/HDPN OUT RJ-45

RJ-45 Pin 1 – HI	}	HDPN Lt Out
RJ-45 Pin 2 – LO		
RJ-45 Pin 3 – HI	}	HDPN Rt Out
RJ-45 Pin 6 – LO		

RJ-45 Pin 4 – HI	}	Cue Lt Out
RJ-45 Pin 5 – LO		
RJ-45 Pin 7 – HI	}	Cue Rt Out
RJ-45 Pin 8 – LO		

STUDIO OUT XLR

XLR#1 Pin 1 – SH	}	Studio Lt Out
XLR#1 Pin 2 – HI		
XLR#1 Pin 3 – LO		
XLR#2 Pin 1 – SH	}	Studio Rt Out
XLR#2 Pin 2 – HI		
XLR#2 Pin 3 – LO		

CR OUT XLR

XLR#1 Pin 1 – SH	}	CR Lt Out
XLR#1 Pin 2 – HI		
XLR#1 Pin 3 – LO		
XLR#2 Pin 1 – SH	}	CR Rt Out
XLR#2 Pin 2 – HI		
XLR#2 Pin 3 – LO		

PGM OUT ANALOG RJ-45

RJ-45 A Pin 1 – HI	}	PGM A Lt Out
RJ-45 A Pin 2 – LO		
RJ-45 A Pin 3 – HI	}	PGM A Rt Out
RJ-45 A Pin 6 – LO		
RJ-45 B Pin 1 – HI	}	PGM B Lt Out
RJ-45 B Pin 2 – LO		
RJ-45 B Pin 3 – HI	}	PGM B Rt Out
RJ-45 B Pin 6 – LO		
RJ-45 C Pin 1 – HI	}	PGM C Lt Out
RJ-45 C Pin 2 – LO		
RJ-45 C Pin 3 – HI	}	PGM C Rt Out
RJ-45 C Pin 6 – LO		
RJ-45 D Pin 1 – HI	}	PGM D Lt Out
RJ-45 D Pin 2 – LO		
RJ-45 D Pin 3 – HI	}	PGM D Rt Out
RJ-45 D Pin 6 – LO		

PGM OUT DIGITAL RJ-45

RJ-45 A Pin 1 – HI	}	PGM AES A Out
RJ-45 A Pin 2 – LO		
RJ-45 B Pin 1 – HI	}	PGM AES B Out
RJ-45 B Pin 2 – LO		
RJ-45 C Pin 1 – HI	}	PGM AES C Out
RJ-45 C Pin 2 – LO		
RJ-45 D Pin 1 – HI	}	PGM AES D Out
RJ-45 D Pin 2 – LO		

Model Aura8ip

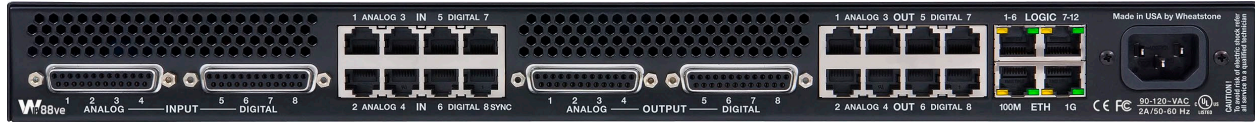

INPUTS

The WheatNet-IP Aura8ip is fed from a combination of analog and digital inputs via two DB-25 or eight RJ-45 connectors.

The WheatNet-IP Aura8ip will accommodate digital inputs having a wide range of sample rates. These inputs will be sample rate converted to the system's chosen sample rate of 44.1kHz or 48kHz, which is set via the WheatNet-IP Navigator GUI. The GUI also allows you to select input 8 of the digital BLADE3, or of any BLADE3 that has a digital input as input 8, to be a primary external reference, and a digital input 8 from a different BLADE3 to be a secondary external reference. Please note that the sample rate of a digital input 8 should be the same, either 44.1kHz or 48kHz, as the system's chosen sample rate. If you are using the Aura8ip in a stand-alone application, one involving no other BLADE3s, and if the outputs from Aura8ip must be synchronized to downstream digital equipment, you must use input 8 for your external reference, even if you are not using all 8 inputs.

AES sources are by design stereo; if the BLADE3 is not set to be stereo the appropriate Left or Right signal within the AES stream will be applied to the signal path.

Analog 1-4 DB-25

Pin 24 – HI	}	Line 1 Lt In
Pin 12 – LO		
Pin 25 – SH		
Pin 10 – HI	}	Line 1 Rt In
Pin 23 – LO		
Pin 11 – SH		
Pin 21 – HI	}	Line 2 Lt In
Pin 9 – LO		
Pin 22 – SH		
Pin 7 – HI	}	Line 2 Rt In
Pin 20 – LO		
Pin 8 – SH		
Pin 18 – HI	}	Line 3 Lt In
Pin 6 – LO		
Pin 19 – SH		
Pin 4 – HI	}	Line 3 Rt In
Pin 17 – LO		
Pin 5 – SH		
Pin 15 – HI	}	Line 4 Lt In
Pin 3 – LO		
Pin 16 – SH		
Pin 1 – HI	}	Line 4 Rt In
Pin 14 – LO		
Pin 2 – SH		

Digital 5-8 DB-25

Pin 24 – HI	}	AES 5 In
Pin 12 – LO		
Pin 25 – SH		
Pin 21 – HI	}	AES 6 In
Pin 9 – LO		
Pin 22 – SH		
Pin 18 – HI	}	AES 7 In
Pin 6 – LO		
Pin 19 – SH		
Pin 15 – HI	}	AES 8 In
Pin 3 – LO		
Pin 16 – SH		

Analog 1-4 RJ-45

RJ-45#1 Pin 1 – HI	}	Line 1 Lt In
RJ-45#1 Pin 2 – LO		
RJ-45#1 Pin 3 – HI	}	Line 1 Rt In
RJ-45#1 Pin 6 – LO		
RJ-45#2 Pin 1 – HI	}	Line 2 Lt In
RJ-45#2 Pin 2 – LO		
RJ-45#2 Pin 3 – HI	}	Line 2 Rt In
RJ-45#2 Pin 6 – LO		
RJ-45#3 Pin 1 – HI	}	Line 3 Lt In
RJ-45#3 Pin 2 – LO		
RJ-45#3 Pin 3 – HI	}	Line 3 Rt In
RJ-45#3 Pin 6 – LO		
RJ-45#4 Pin 1 – HI	}	Line 4 Lt In
RJ-45#4 Pin 2 – LO		
RJ-45#4 Pin 3 – HI	}	Line 4 Rt In
RJ-45#4 Pin 6 – LO		

Digital 5-8 RJ-45

RJ-45#5 Pin 1 – HI	}	AES 5 In
RJ-45#5 Pin 2 – LO		
RJ-45#6 Pin 1 – HI	}	AES 6 In
RJ-45#6 Pin 2 – LO		
RJ-45#7 Pin 1 – HI	}	AES 7 In
RJ-45#7 Pin 2 – LO		
RJ-45#8 Pin 1 – HI	}	AES 8 In
RJ-45#8 Pin 2 – LO		

OUTPUTS**Analog 1-4 DB-25**

Pin 24 – HI	}	Line 1 Lt Out
Pin 12 – LO		
Pin 25 – SH		
Pin 10 – HI	}	Line 1 Rt Out
Pin 23 – LO		
Pin 11 – SH		

Pin 21 – HI]	Line 2 Lt Out
Pin 9 – LO		
Pin 22 – SH		
Pin 7 – HI]	Line 2 Rt Out
Pin 20 – LO		
Pin 8 – SH		
Pin 18 – HI]	Line 3 Lt Out
Pin 6 – LO		
Pin 19 – SH		
Pin 4 – HI]	Line 3 Rt Out
Pin 17 – LO		
Pin 5 – SH		
Pin 15 – HI]	Line 4 Lt Out
Pin 3 – LO		
Pin 16 – SH		
Pin 1 – HI]	Line 4 Rt Out
Pin 14 – LO		
Pin 2 – SH		

Digital 5-8 DB-25

Pin 24 – HI]	AES 5 Out
Pin 12 – LO		
Pin 25 – SH		
Pin 21 – HI]	AES 6 Out
Pin 9 – LO		
Pin 22 – SH		
Pin 18 – HI]	AES 7 Out
Pin 6 – LO		
Pin 19 – SH		
Pin 15 – HI]	AES 8 Out
Pin 3 – LO		
Pin 16 – SH		

Analog 1-4 RJ-45

RJ-45#1 Pin 1 – HI]	Line 1 Lt Out
RJ-45#1 Pin 2 – LO		
RJ-45#1 Pin 3 – HI]	Line 1 Rt Out
RJ-45#1 Pin 6 – LO		
RJ-45#2 Pin 1 – HI]	Line 2 Lt Out
RJ-45#2 Pin 2 – LO		
RJ-45#2 Pin 3 – HI]	Line 2 Rt Out
RJ-45#2 Pin 6 – LO		
RJ-45#3 Pin 1 – HI]	Line 3 Lt Out
RJ-45#3 Pin 2 – LO		
RJ-45#3 Pin 3 – HI]	Line 3 Rt Out
RJ-45#3 Pin 6 – LO		
RJ-45#4 Pin 1 – HI]	Line 4 Lt Out
RJ-45#4 Pin 2 – LO		
RJ-45#4 Pin 3 – HI]	Line 4 Rt Out
RJ-45#4 Pin 6 – LO		

Digital 5-8 RJ-45

RJ-45#5 Pin 1 – HI]	AES 5 Out
RJ-45#5 Pin 2 – LO		
RJ-45#6 Pin 1 – HI]	AES 6 Out
RJ-45#6 Pin 2 – LO		
RJ-45#7 Pin 1 – HI]	AES 7 Out
RJ-45#7 Pin 2 – LO		
RJ-45#8 Pin 1 – HI]	AES 8 Out
RJ-45#8 Pin 2 – LO		

Model MADI



Digital Audio Connections

A pair of 75 ohm BNC connectors are provided on the rear panel for input and output connections. All connections should be made with a high quality 75 ohm coaxial cable terminated to male BNC connectors. By installing digital video grade coax, cable runs of 200M or more can be realized.

BNC IN Pin 1 – HI]	AES In
BNC IN Pin 2 – SH		
BNC OUT Pin 1 – HI]	AES Out
BNC OUT Pin 2 – SH		

Optical Fiber Interface

The MADI BLADE3 supports an optional fiber connection to the Bridge/Gibraltar Router or other 3rd-party devices. The MADI BLADE uses an SFP module interface with integral LC connectors.

Note that the QOT-2001 rear panel on the Bridge/Gibraltar Router uses SC connectors, so to connect to a Bridge/Gibraltar MADI card a patch cable fitted with LC connectors on one end and SC connectors on the other end is required.

Optical Transceiver

Optical Transceivers convert physical signals from electrical to optical (and vice-versa) in a network and couple the optical signals into (and out of) optical fiber. Small form factor pluggable (SFP) transceivers, used in the MADI BLADE, are designed to be hot-swappable in industry standard cages and connectors (for easy field repair), and offer high speed and physical compactness.

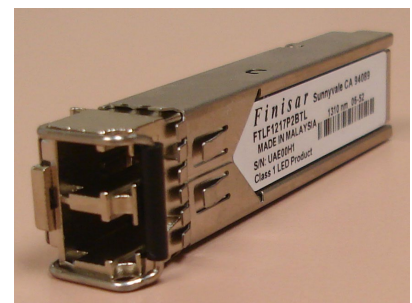

Optical Transceiver

Connector Type

The high-density *LC Duplex* connector has a tabbed locking mechanism similar to what you would find on a phone jack. This enables secure connectivity and easy removal.

The *SC* (subscription channel) *Duplex* connector is a low insertion loss connector using a push/pull locking mechanism.

Optical Fiber Cable

The SC-LC optical fiber cable required in this application is a multimode duplex fiber optic patch cable with a core/cladding size *62.5/125 micron* suitable for low-to-moderate-speed data links ($\leq 100\text{Mbps}$). The following Fiber Instrument Sales, Inc. part number X2YLM3FISC may be used to reference the physical characteristics of the required cable assembly. The full-duplex nature of the audio network interface requires one fiber for transmit, and one for receive; hence dual zip cables are recommended.

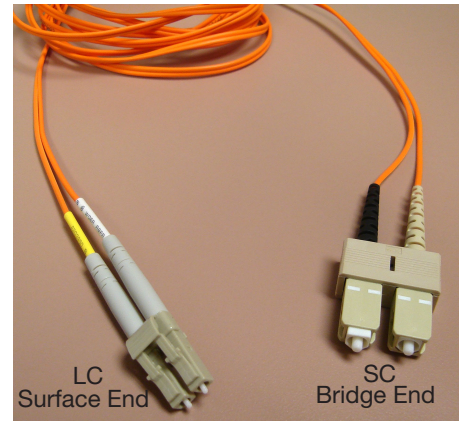

Optical Fiber Cable

Optical fiber cables are manufactured with a variety of jacket materials, which directly affect cable cost, including Thermoplastic Elastomer (TPE), Kynar® and Teflon® FEP. Physical properties of the jacket material determine a cable's resistance to abrasions, flame retardancy, etc. *Check local codes to be sure the cable you plan on using is compliant in your application.*

Model M4IP



INPUTS

The M4IP analog mono mic level input (-50dBu nominal) is fed from the female XLR connector to the internal microphone preamplifier. The mic preamp has digitally controlled gain, up to a maximum of 70 dB , and displays remarkably high performance and accuracy. Phantom power is available.

Analog 1-4 XLR

XLR#1 Pin 1 – SH	}	Mic 1 In
XLR#1 Pin 2 – HI		
XLR#1 Pin 3 – LO		
XLR#2 Pin 1 – SH	}	Mic 2 In
XLR#2 Pin 2 – HI		
XLR#2 Pin 3 – LO		
XLR#3 Pin 1 – SH	}	Mic 3 In
XLR#3 Pin 2 – HI		
XLR#3 Pin 3 – LO		
XLR#4 Pin 1 – SH	}	Mic 4 In
XLR#4 Pin 2 – HI		
XLR#4 Pin 3 – LO		

OUTPUTS

The output signals are available as analog line level (+4dBu, balanced) on the DB-25 connector, or on the four RJ-45 (#1 through #4) connectors, and as four digital AES formatted outputs on the RJ-45 (#5 through #8) connectors.

Analog 1-4 DB-25

Pin 24 – HI	}	Line 1 Lt Out
Pin 12 – LO		
Pin 25 – SH		
Pin 10 – HI	}	Line 1 Rt Out
Pin 23 – LO		
Pin 11 – SH		
Pin 21 – HI	}	Line 2 Lt Out
Pin 9 – LO		
Pin 22 – SH		
Pin 7 – HI	}	Line 2 Rt Out
Pin 20 – LO		
Pin 8 – SH		
Pin 18 – HI	}	Line 3 Lt Out
Pin 6 – LO		
Pin 19 – SH		
Pin 4 – HI	}	Line 3 Rt Out
Pin 17 – LO		
Pin 5 – SH		
Pin 15 – HI	}	Line 4 Lt Out
Pin 3 – LO		
Pin 16 – SH		
Pin 1 – HI	}	Line 4 Rt Out
Pin 14 – LO		
Pin 2 – SH		

Analog 1-4 RJ-45

RJ-45#1 Pin 1 – HI	}	Line 1 Lt Out
RJ-45#1 Pin 2 – LO		
RJ-45#1 Pin 3 – HI	}	Line 1 Rt Out
RJ-45#1 Pin 6 – LO		
RJ-45#2 Pin 1 – HI	}	Line 2 Lt Out
RJ-45#2 Pin 2 – LO		
RJ-45#2 Pin 3 – HI	}	Line 2 Rt Out
RJ-45#2 Pin 6 – LO		
RJ-45#3 Pin 1 – HI	}	Line 3 Lt Out
RJ-45#3 Pin 2 – LO		
RJ-45#3 Pin 3 – HI	}	Line 3 Rt Out
RJ-45#3 Pin 6 – LO		
RJ-45#4 Pin 1 – HI	}	Line 4 Lt Out
RJ-45#4 Pin 2 – LO		
RJ-45#4 Pin 3 – HI	}	Line 4 Rt Out
RJ-45#4 Pin 6 – LO		

Digital 5-8 RJ-45

RJ-45#5 Pin 1 – HI	}	AES 5 Out
RJ-45#5 Pin 2 – LO		
RJ-45#6 Pin 1 – HI	}	AES 6 Out
RJ-45#6 Pin 2 – LO		
RJ-45#7 Pin 1 – HI	}	AES 7 Out
RJ-45#7 Pin 2 – LO		
RJ-45#8 Pin 1 – HI	}	AES 8 Out
RJ-45#8 Pin 2 – LO		

Model HD-SDI

There are four pairs of the BNC IN and LOOP connectors for four SDI inputs and one pair of the BNC DARS IN/OUT connectors.

BNC IN Pin 1 – HI	}	SDI A, B, C, D
BNC IN Pin 2 – SH		
BNC LOOP Pin 1 – HI		
BNC LOOP Pin 2 – SH		

BNC DARS IN Pin 1 – HI	}	DARS
BNC DARS IN Pin 2 – LO		
BNC DARS OUT Pin 1 – HI		
BNC DARS OUT Pin 2 – LO		

Logic Ports - All Models (except LIO-48)

All models, with exception of the LIO-48, have two LOGIC I/O RJ-45 connectors that provide 12 Universal logic ports.

LOGIC I/O 1 - 6 RJ-45

RJ-45 Pin 1 – Digital Ground
RJ-45 Pin 2 – Logic 1 In/Out
RJ-45 Pin 3 – Logic 2 In/Out
RJ-45 Pin 4 – Logic 3 In/Out
RJ-45 Pin 5 – Logic 4 In/Out
RJ-45 Pin 6 – Logic 5 In/Out
RJ-45 Pin 7 – Logic 6 In/Out
RJ-45 Pin 8 – +5V Digital

LOGIC I/O 7 - 12 RJ-45

RJ-45 Pin 1 – Digital Ground
RJ-45 Pin 2 – Logic 7 In/Out
RJ-45 Pin 3 – Logic 8 In/Out
RJ-45 Pin 4 – Logic 9 In/Out
RJ-45 Pin 5 – Logic 10 In/Out
RJ-45 Pin 6 – Logic 11 In/Out
RJ-45 Pin 7 – Logic 12 In/Out
RJ-45 Pin 8 – +5V Digital

LIO-48 Logic Ports



The rear panel has eight RJ-45 connectors that have the connections for all 48 ports (each RJ-45 has connections for six ports). Two DB-25 female connectors duplicate the logic port connections. A DB-9 female connector provides access to +5VDC from the BLADE.

LOGIC I/O “A” RJ-45

- RJ-45 Pin 1 – Digital Ground
- RJ-45 Pin 2 – Logic 1 In/Out
- RJ-45 Pin 3 – Logic 2 In/Out
- RJ-45 Pin 4 – Logic 3 In/Out
- RJ-45 Pin 5 – Logic 4 In/Out
- RJ-45 Pin 6 – Logic 5 In/Out
- RJ-45 Pin 7 – Logic 6 In/Out
- RJ-45 Pin 8 – +5V Digital

All “LOGIC RJ PORTS” connectors wired in same manner as the “A” connector shown above.

LOGIC I/O “1 - 24” DB-25

- Pin 1 – Logic 1 In/Out
- Pin 2 – Logic 2 In/Out
- Pin 3 – Logic 3 In/Out
- Pin 4 – Logic 4 In/Out
- Pin 5 – Logic 5 In/Out
- Pin 6 – Logic 6 In/Out
- Pin 7 – Logic 7 In/Out
- Pin 8 – Logic 8 In/Out
- Pin 9 – Logic 9 In/Out
- Pin 10 – Logic 10 In/Out
- Pin 11 – Logic 11 In/Out
- Pin 12 – Logic 12 In/Out
- Pin 13 – Logic 13 In/Out
- Pin 14 – Logic 14 In/Out
- Pin 15 – Logic 15 In/Out
- Pin 16 – Logic 16 In/Out
- Pin 17 – Logic 17 In/Out
- Pin 18 – Logic 18 In/Out
- Pin 19 – Logic 19 In/Out
- Pin 20 – Logic 20 In/Out
- Pin 21 – Logic 21 In/Out
- Pin 22 – Logic 22 In/Out
- Pin 23 – Logic 23 In/Out
- Pin 24 – Logic 24 In/Out
- Pin 25 – Digital Ground

The “25-48” DB-25 connector wired in same manner as the “A” connector shown above.

+5VDC LOGIC DB-9

- Pin 1 – +5V Logic 1
- Pin 2 – +5V Logic 2
- Pin 3 – +5V Logic 3
- Pin 4 – +5V Logic 4
- Pin 5 – +5V Logic 5
- Pin 6 – +5V Logic 6
- Pin 7 – +5V Logic 7
- Pin 8 – +5V Logic 8
- Pin 9 – Digital Ground

Simplified BLADE Logic I/O

Input Logic

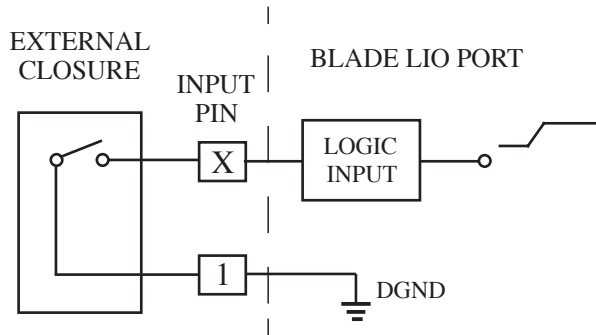

Input Port Specs
• Internally current limited
• No pull up required

Logic Inputs are activated when the input pin is pulled to DGND.

Output Logic

Logic Output ports are pulled to DGND when activated.

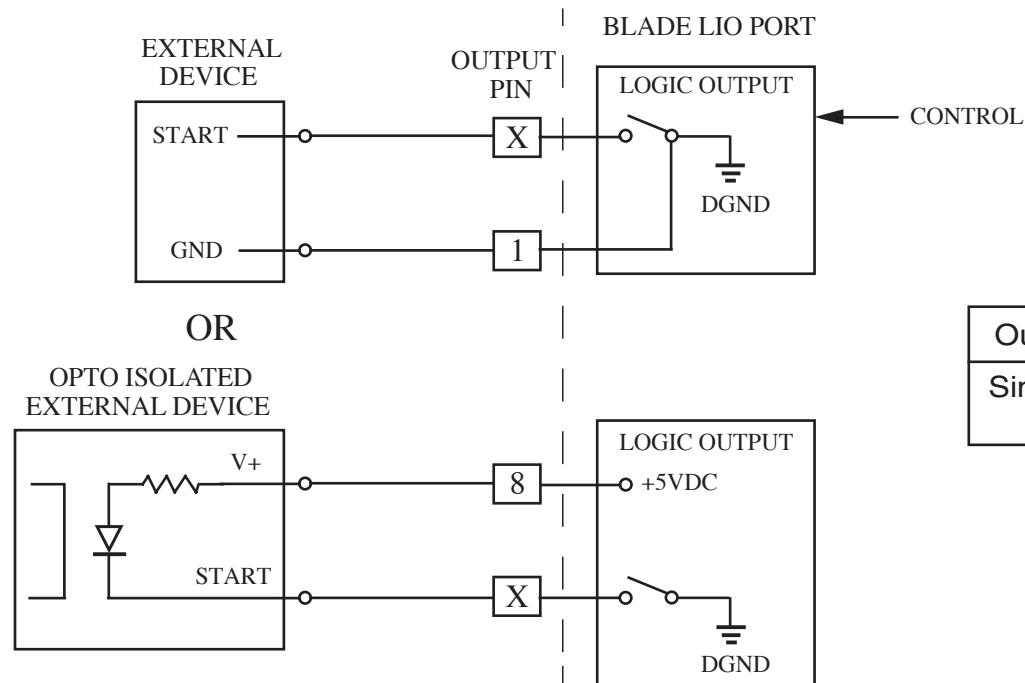

Output Port Specs
Sink: • 50mA nom
• 100mA max

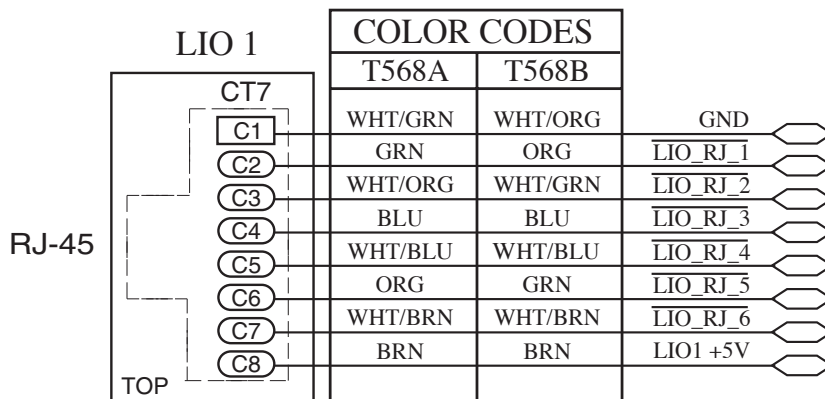

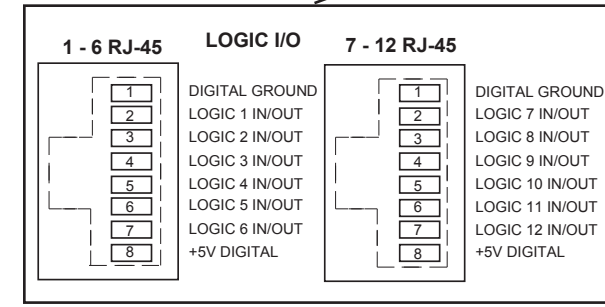
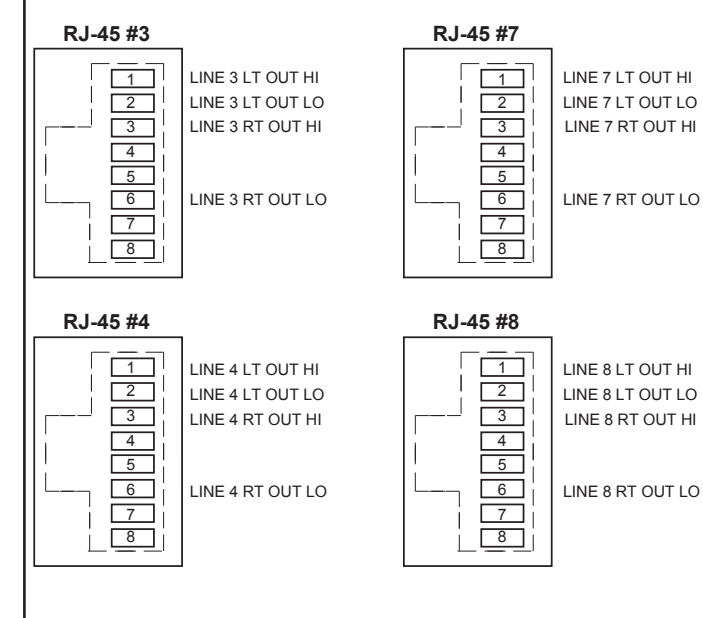
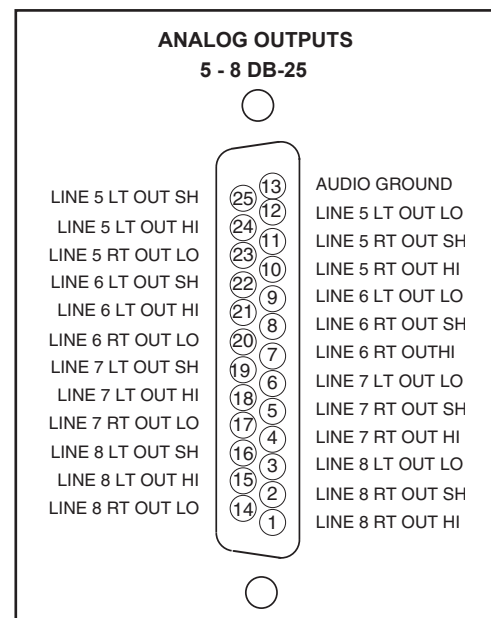
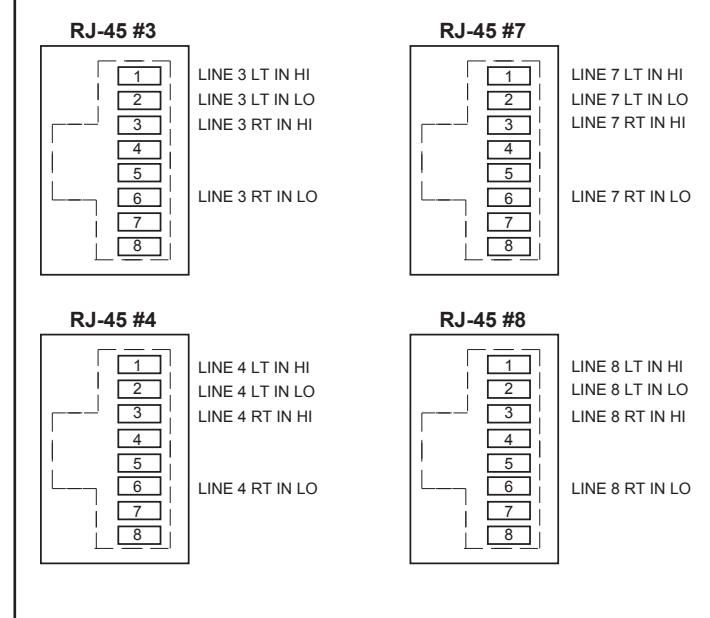
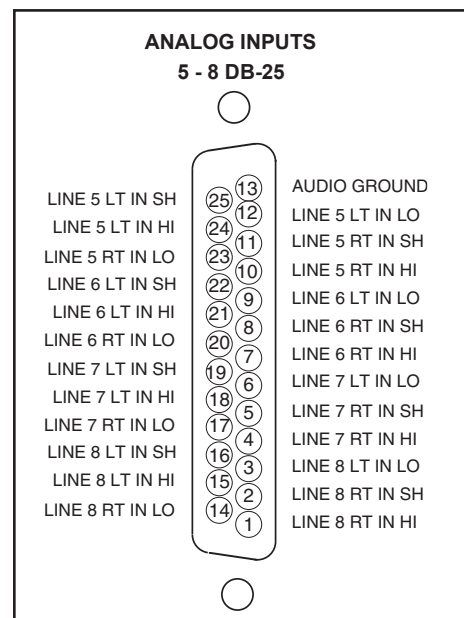
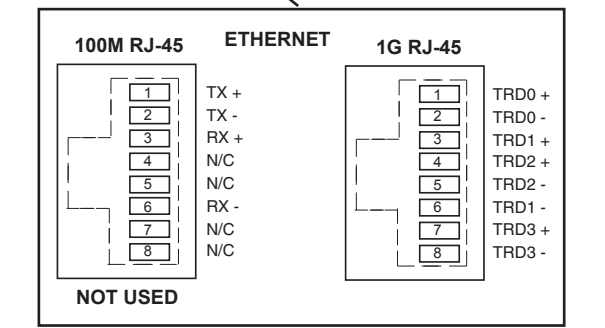
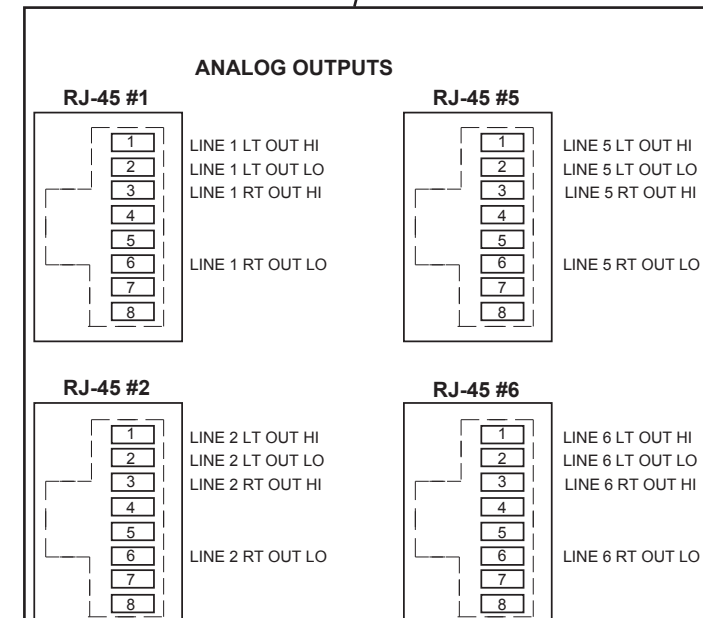
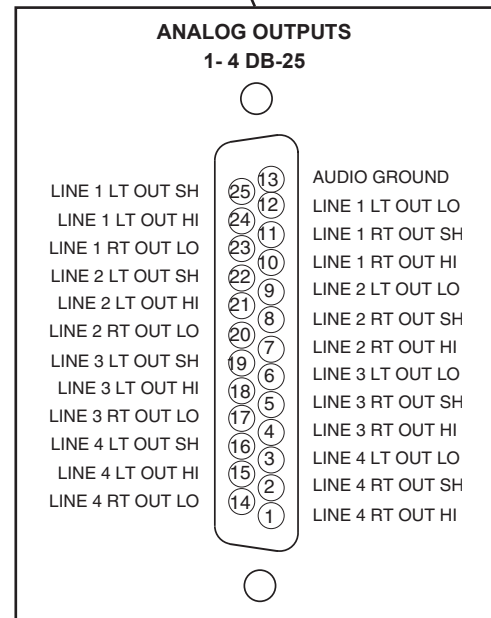
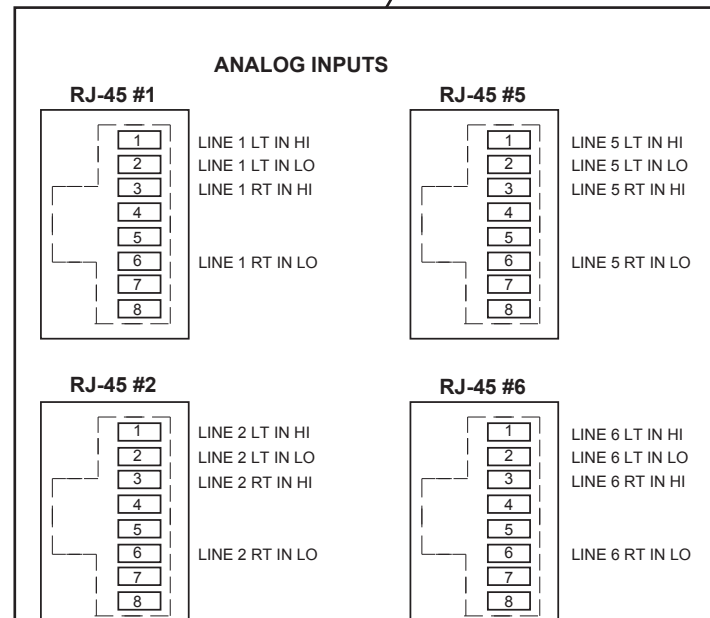
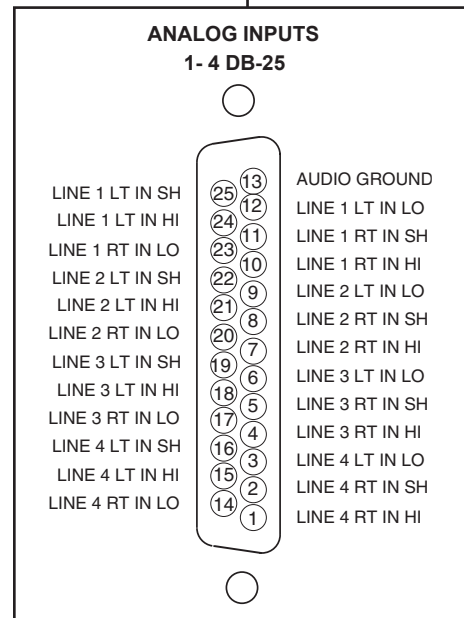

NOTE: DB-25 audio connections and RJ-45 audio connections are paralleled. Either may be used.

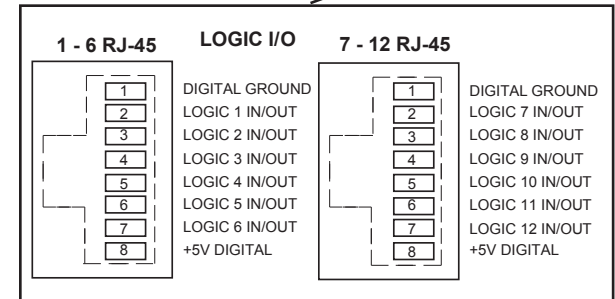
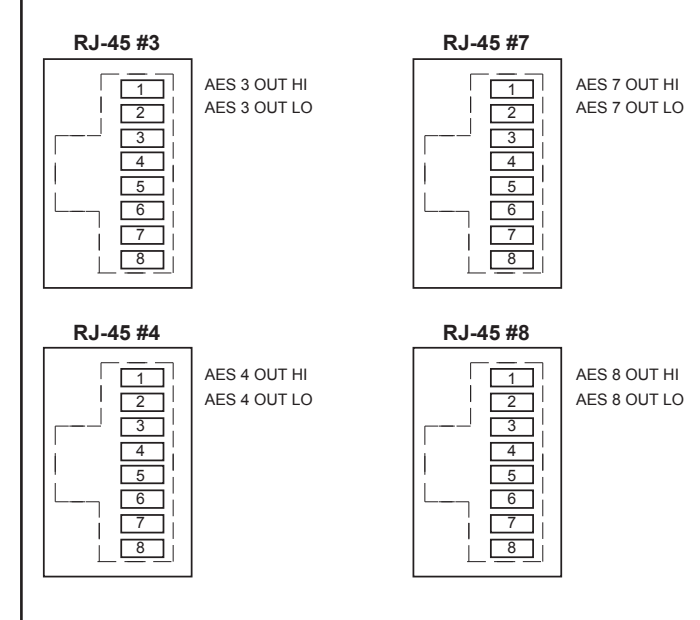
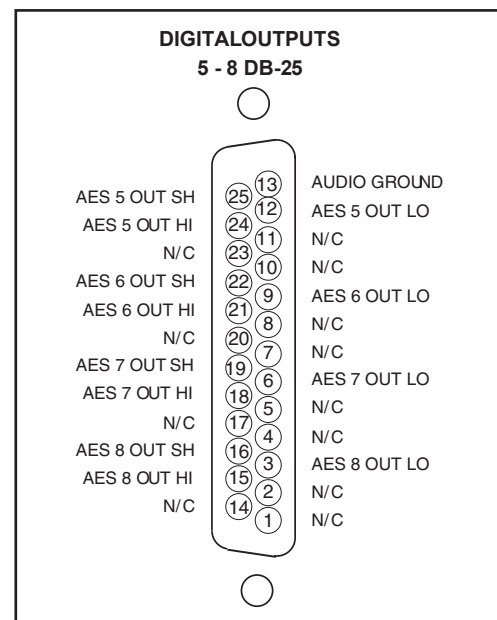
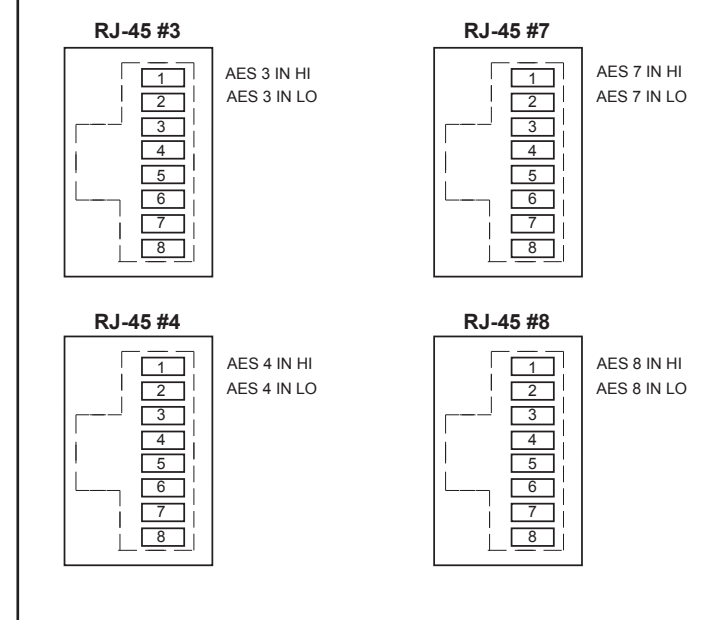
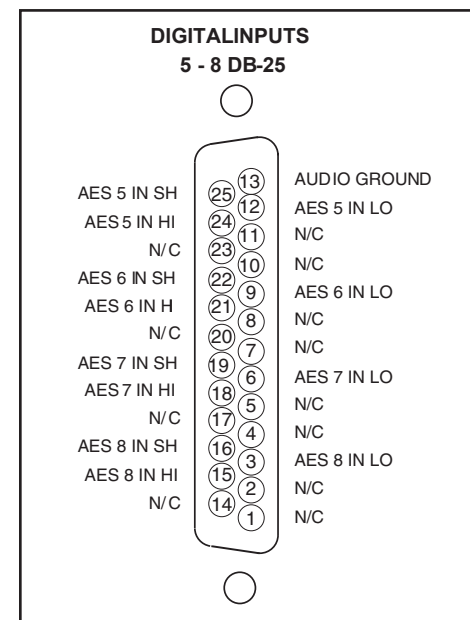
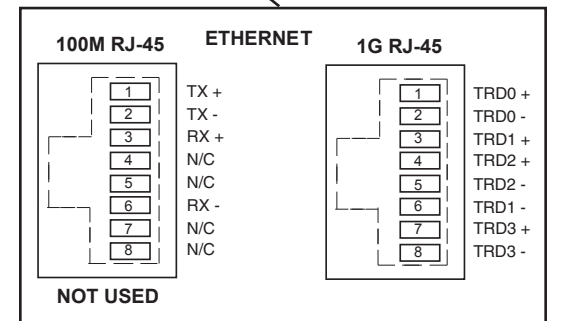
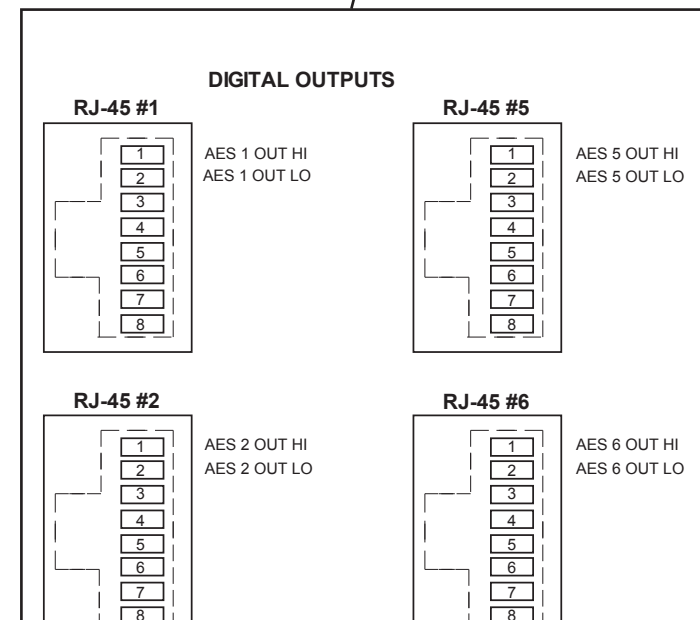
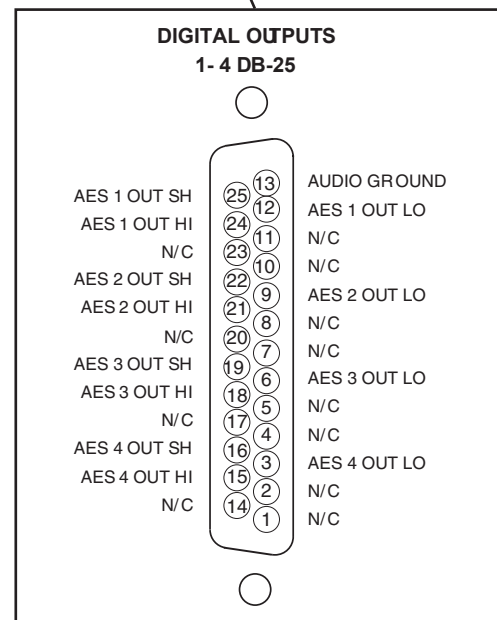
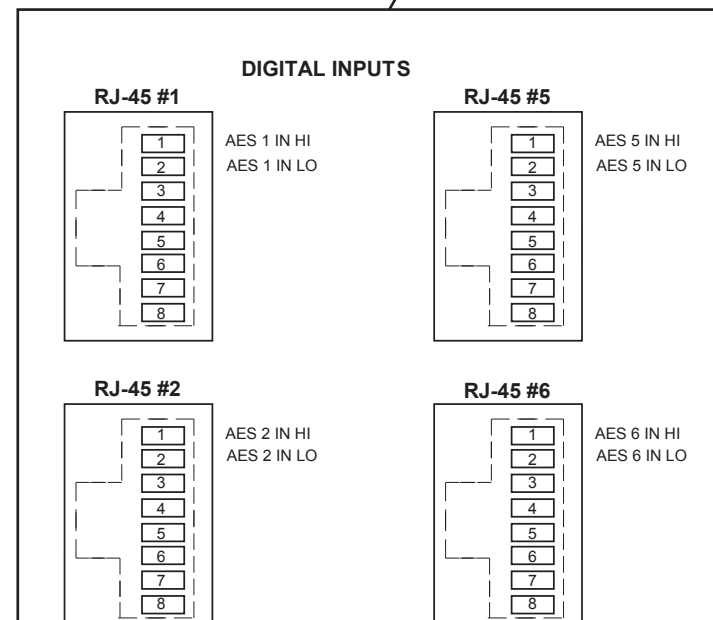
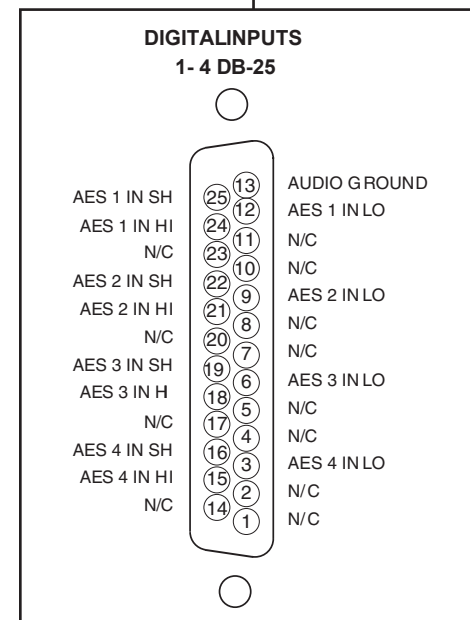
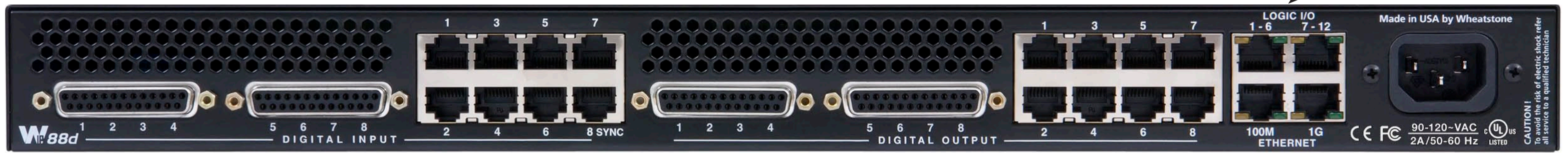

NOTE: DB-25 audio connections and RJ-45 audio connections are paralleled. Either may be used.

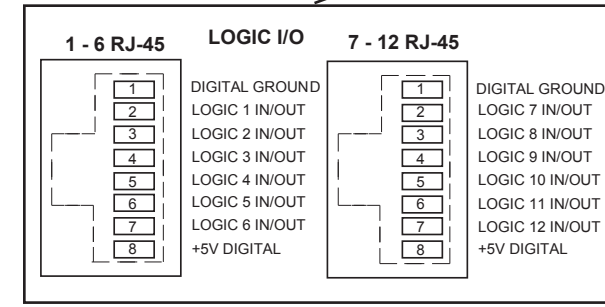
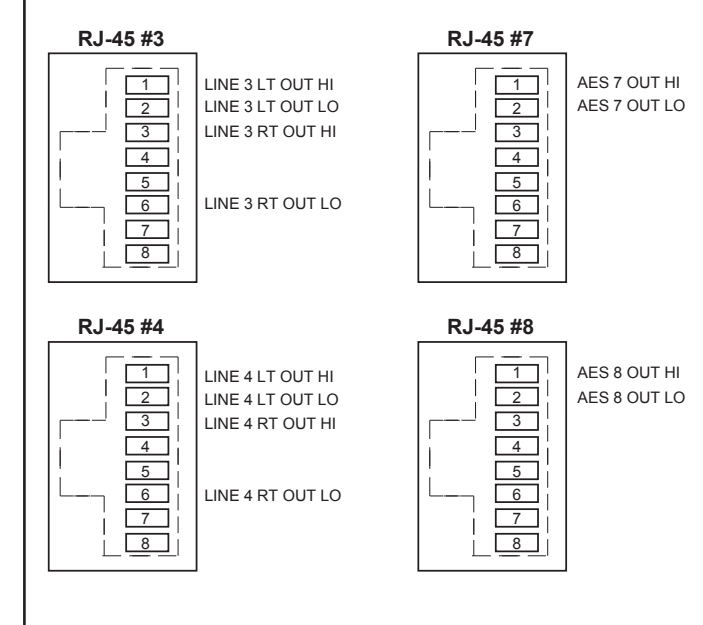
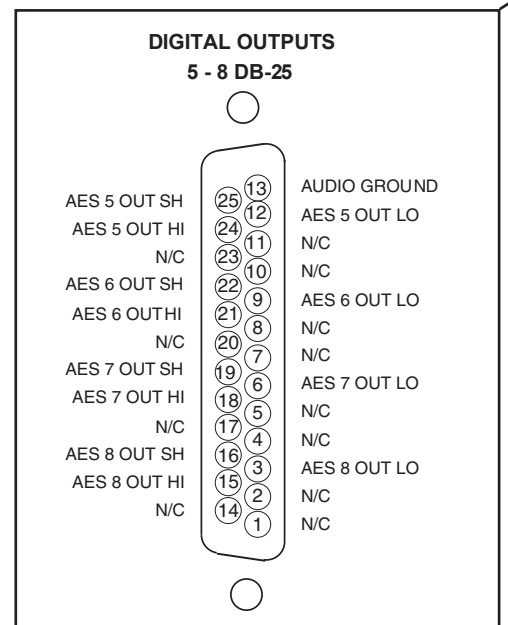
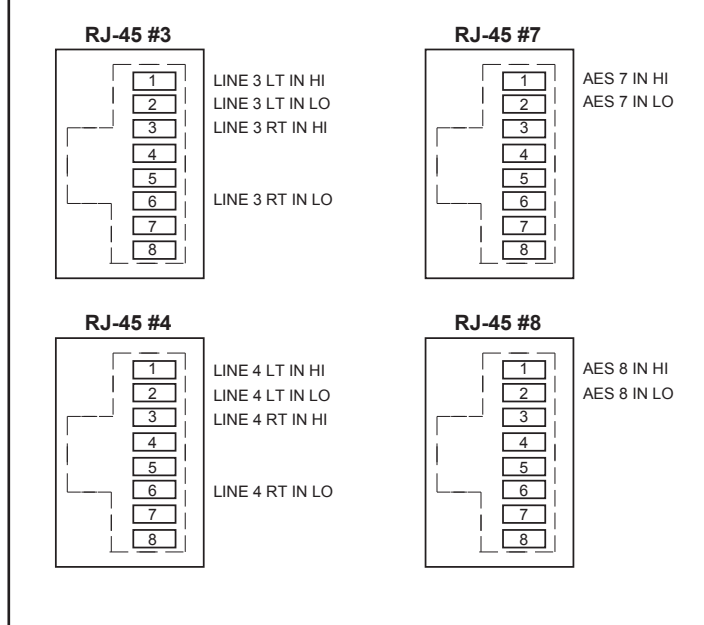
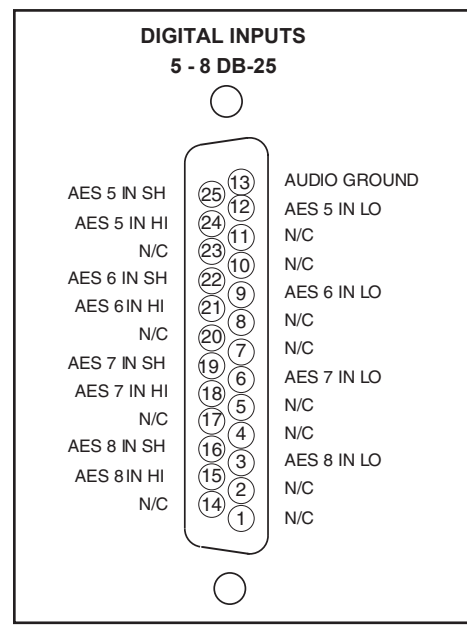
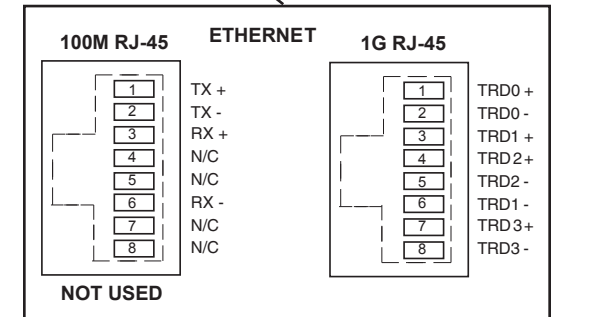
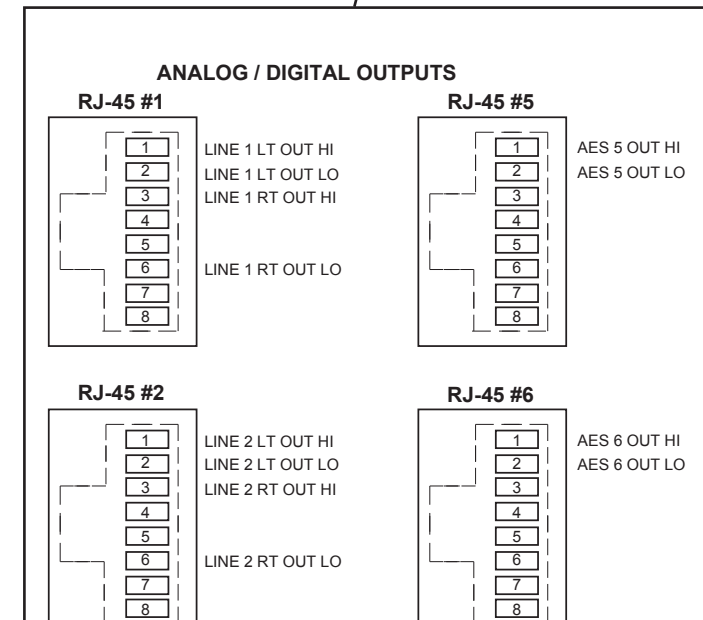
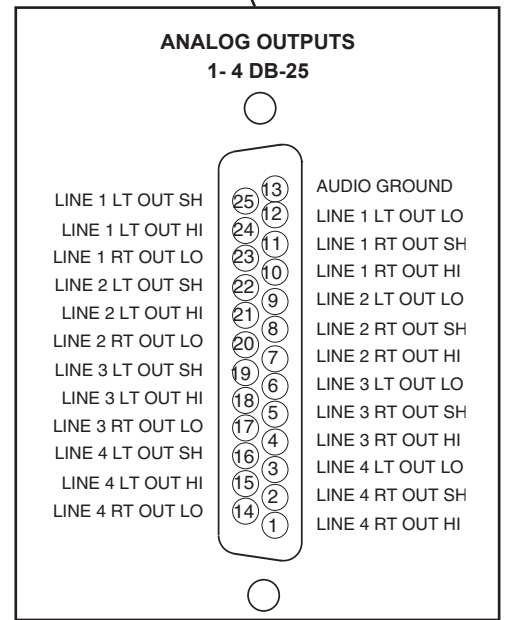
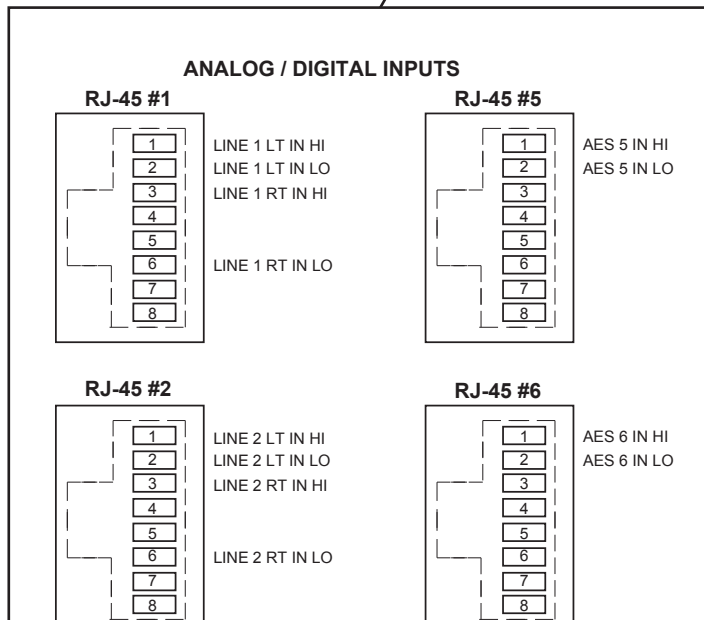
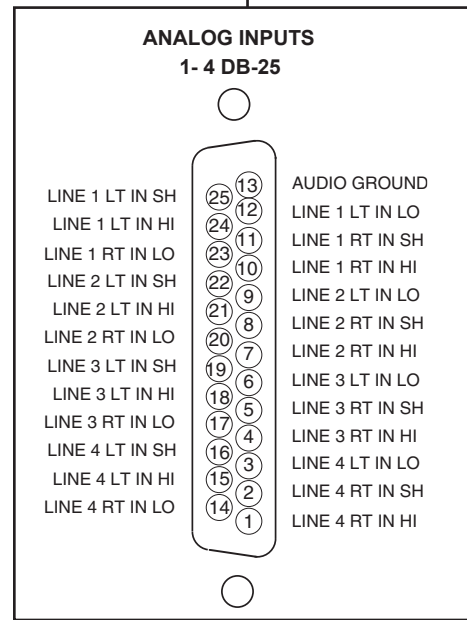
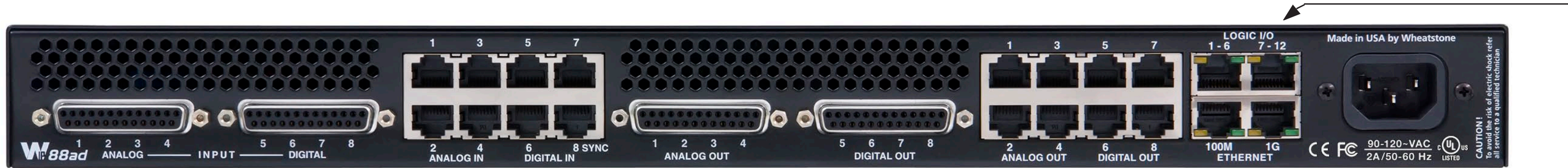

NOTE: DB-25 audio connections and RJ-45 audio connections are paralleled. Either may be used.

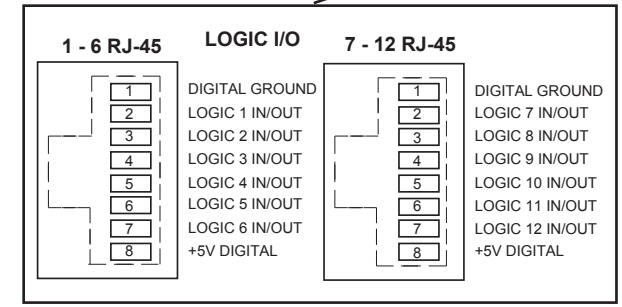
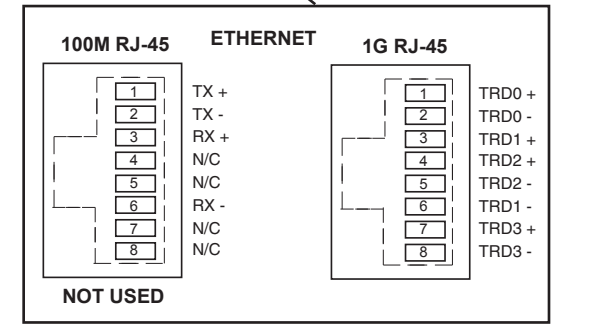
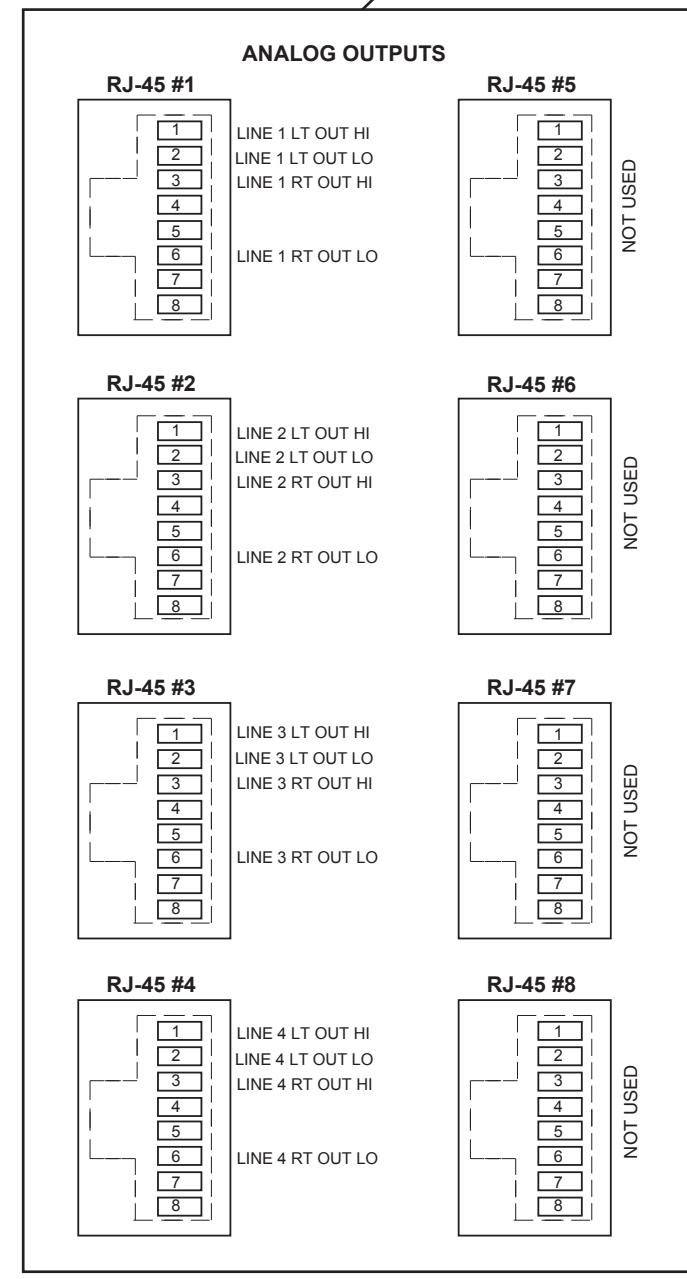
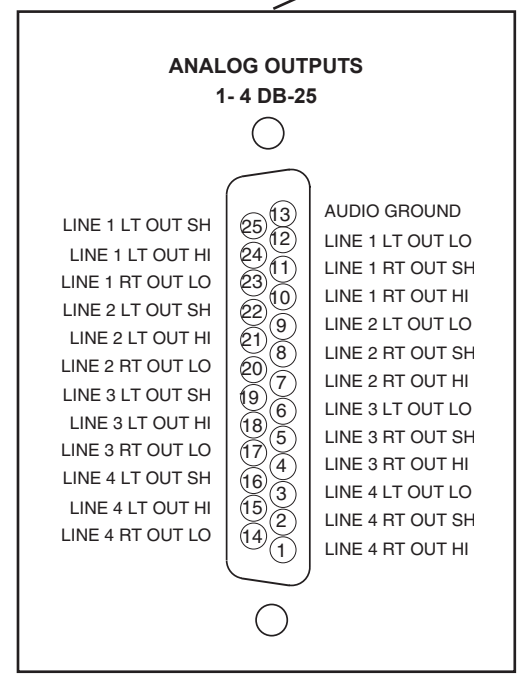
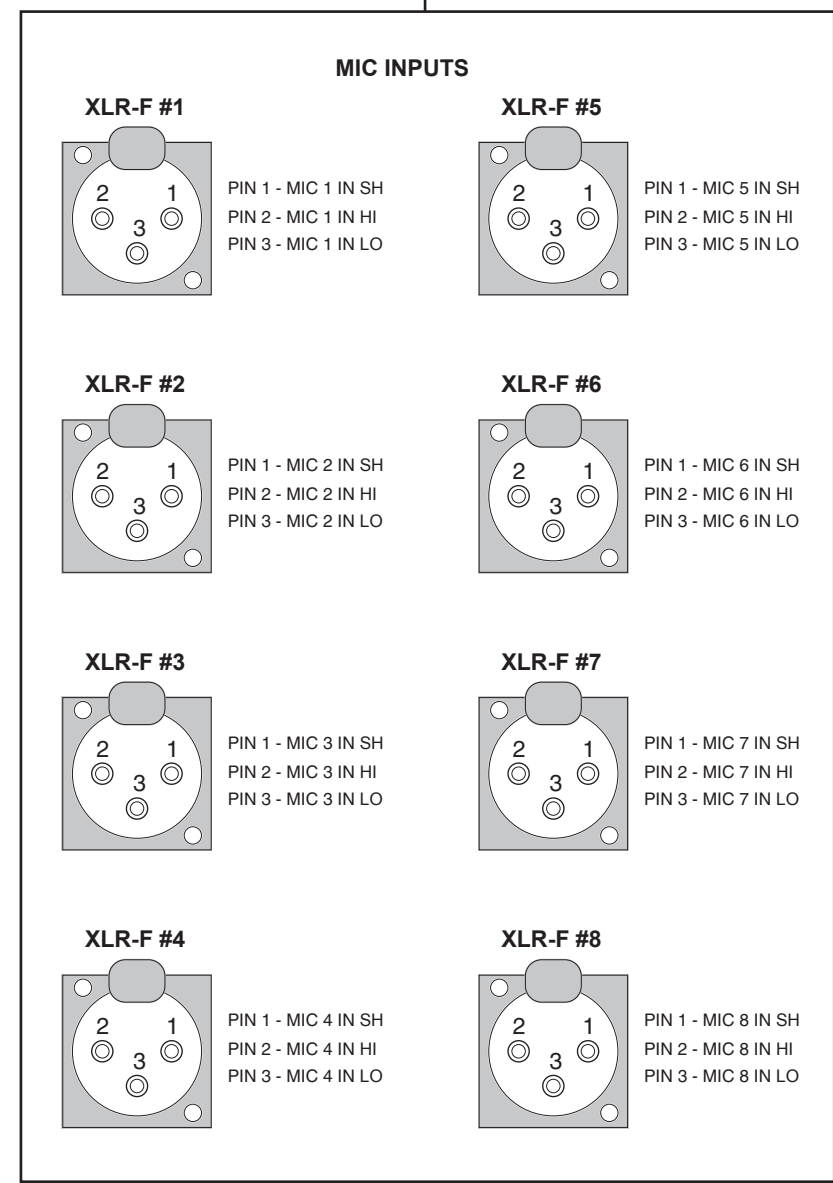

NOTE: DB-25 audio connections and RJ-45 audio connections are paralleled. Either may be used.

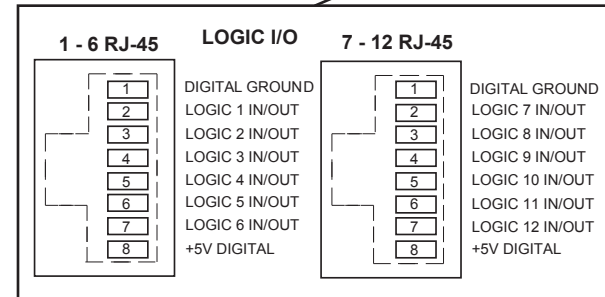
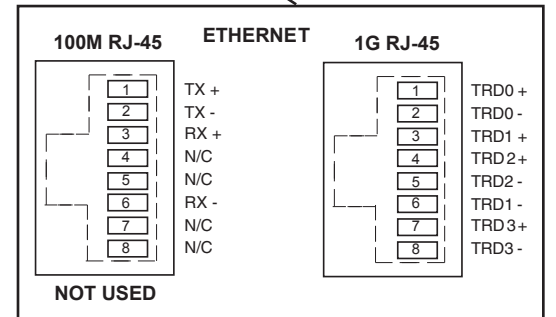
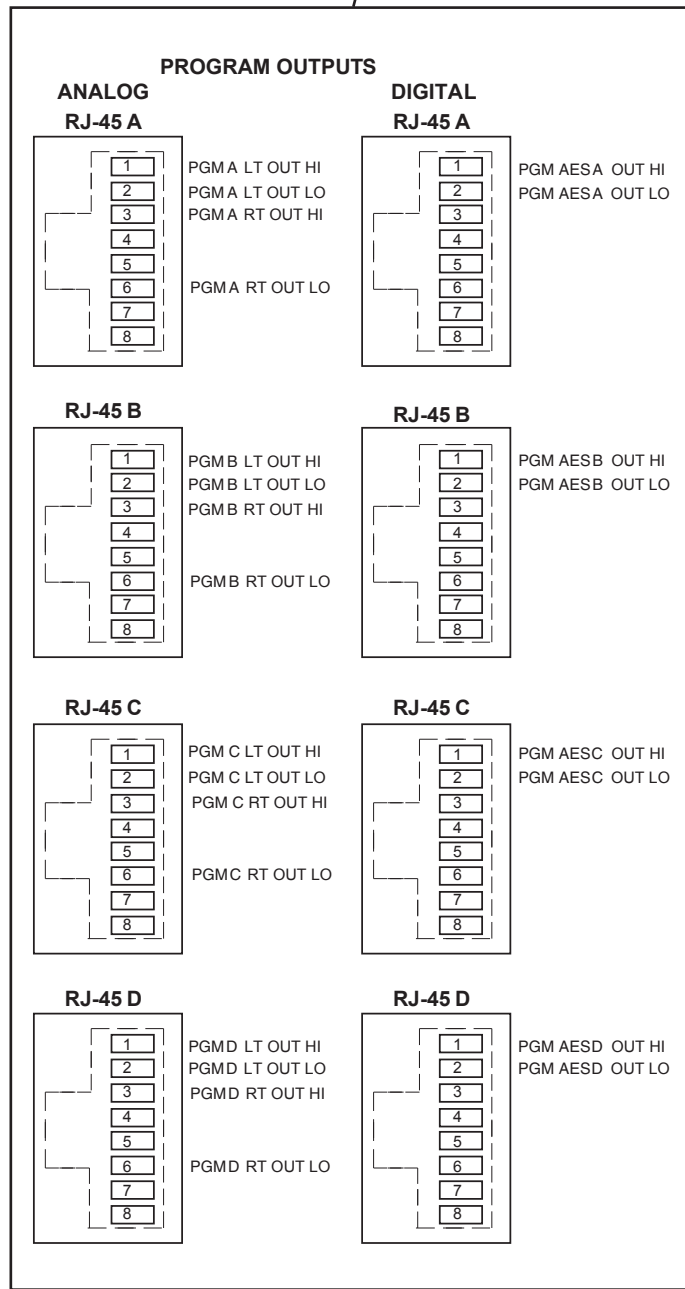
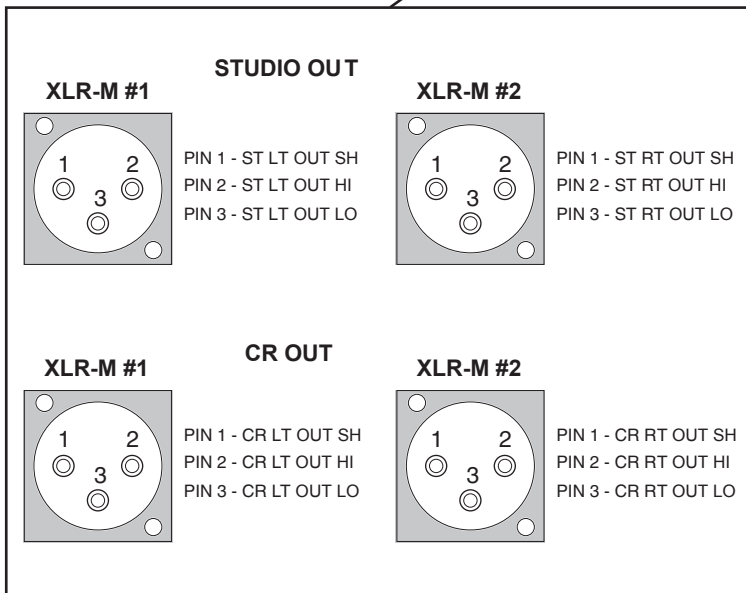
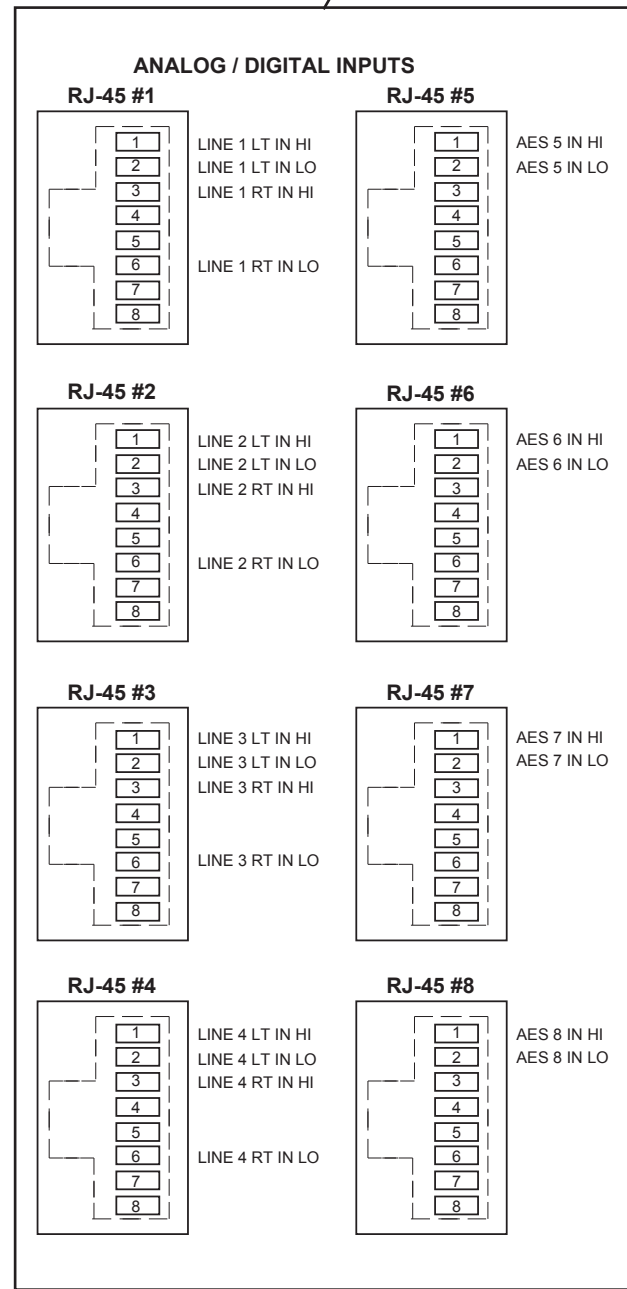
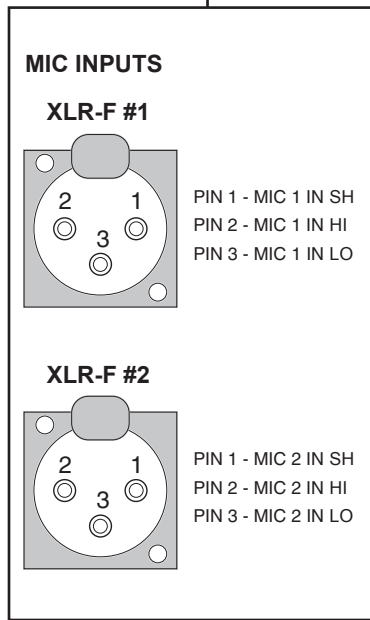

NOTE: DB-25 audio connections and RJ-45 audio connections are paralleled. Either may be used.

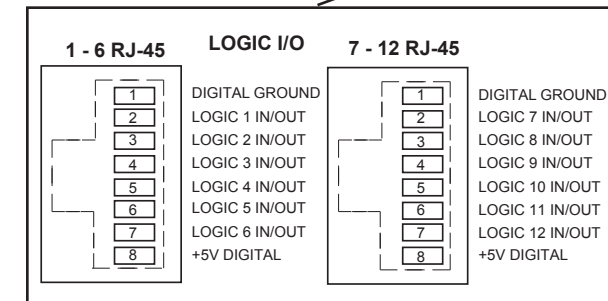
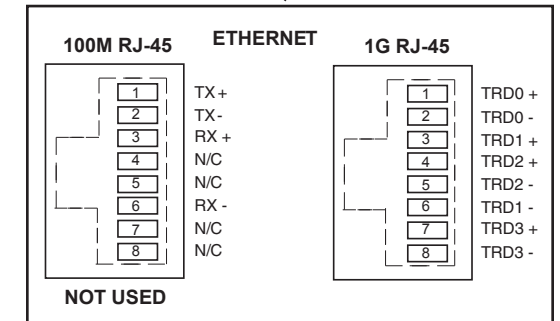
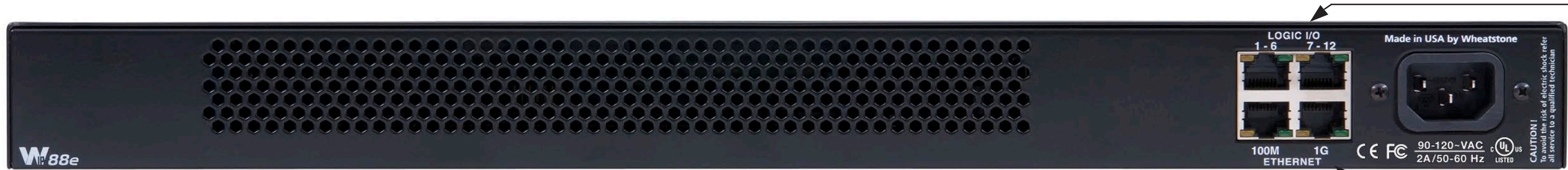

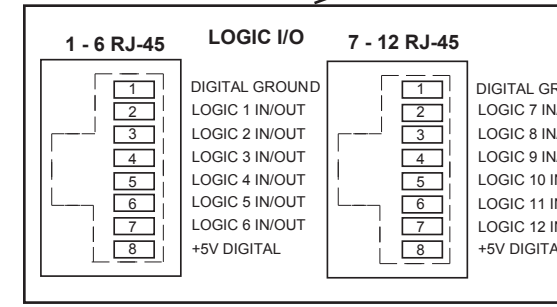
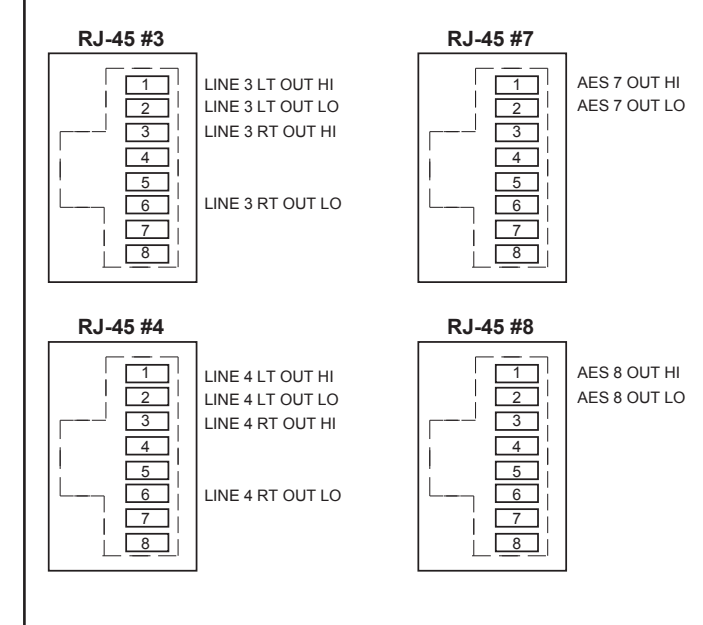
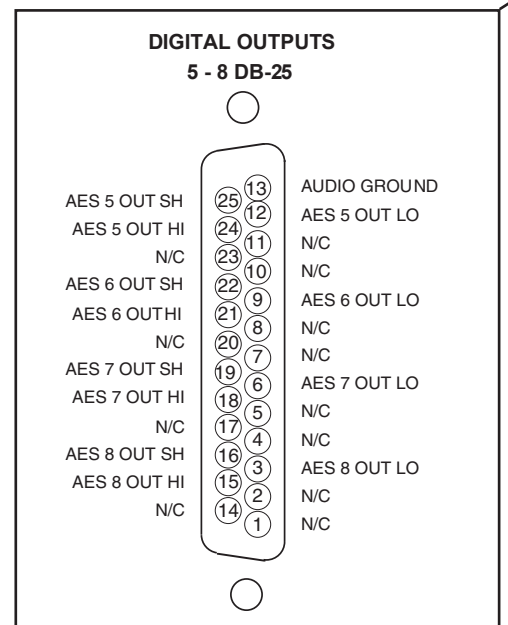
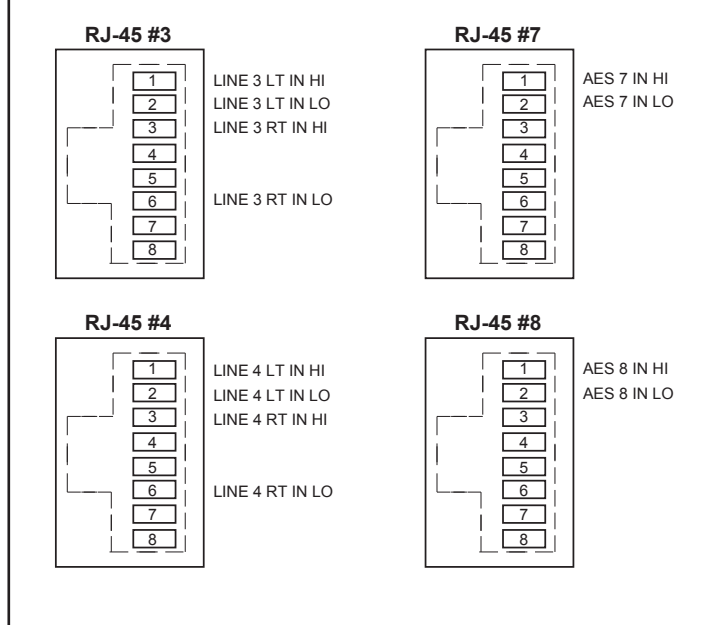
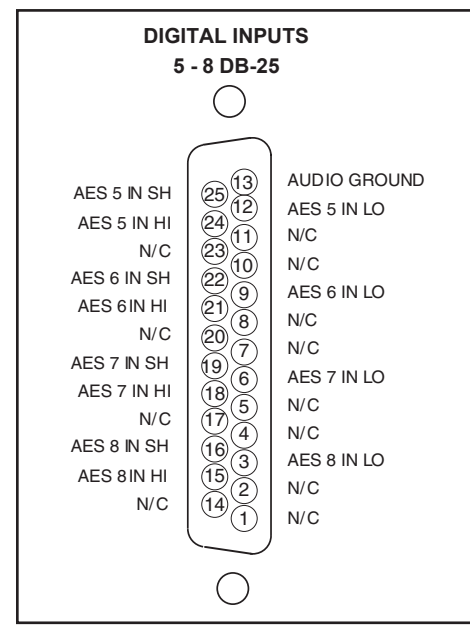
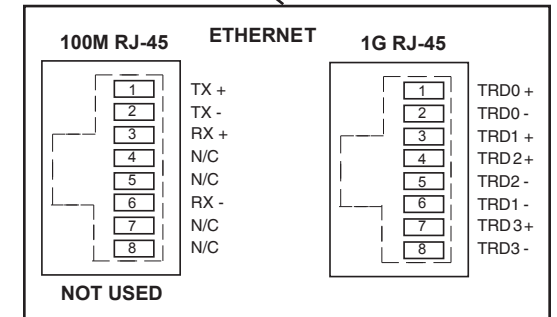
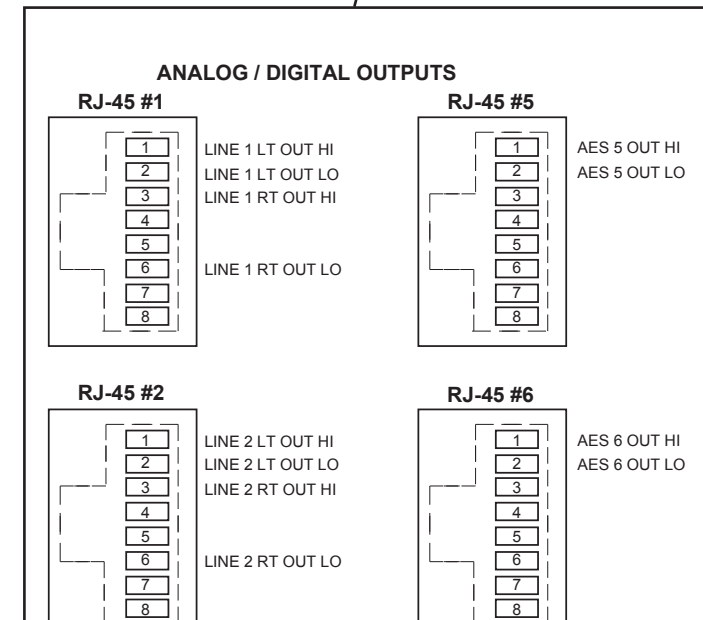
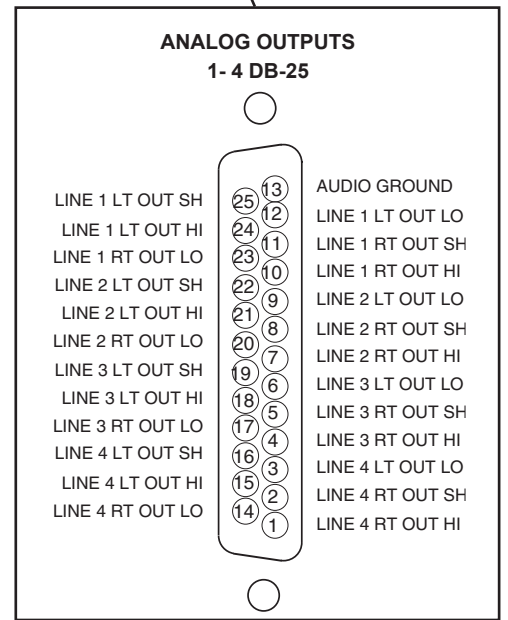
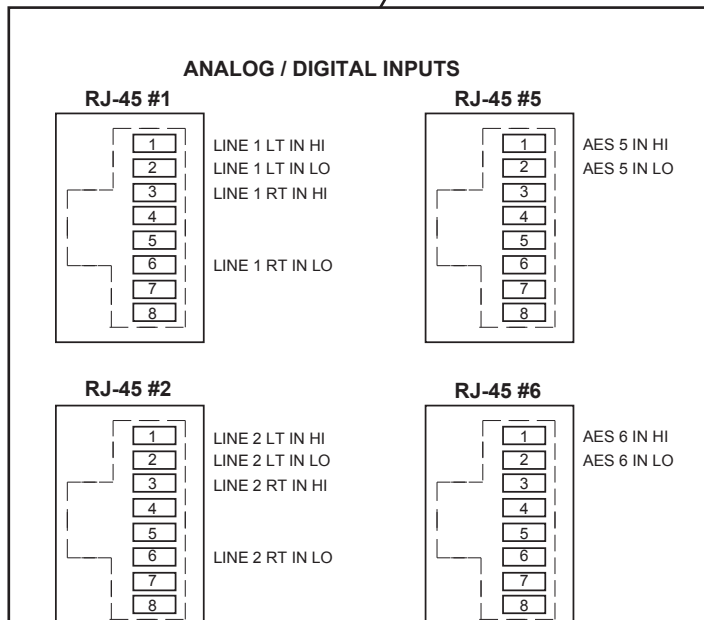
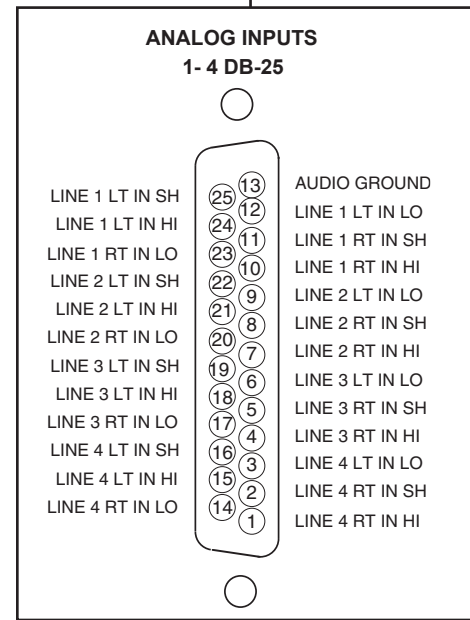
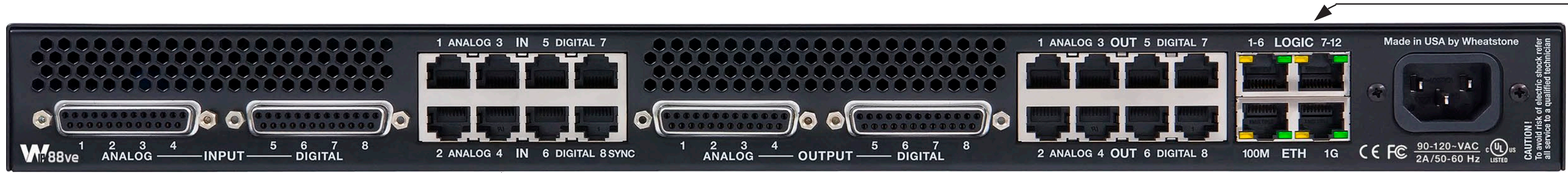

NOTE: DB-25 audio connections and RJ-45 audio connections are paralleled. Either may be used.



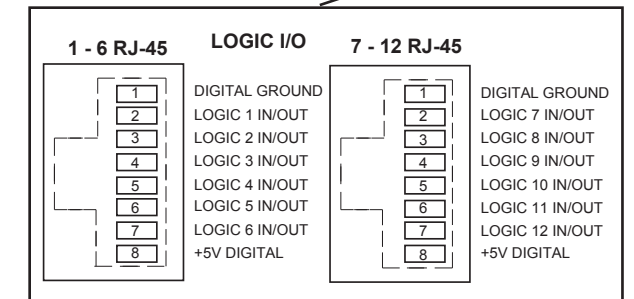
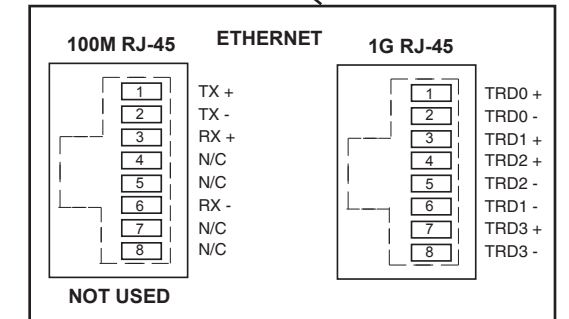
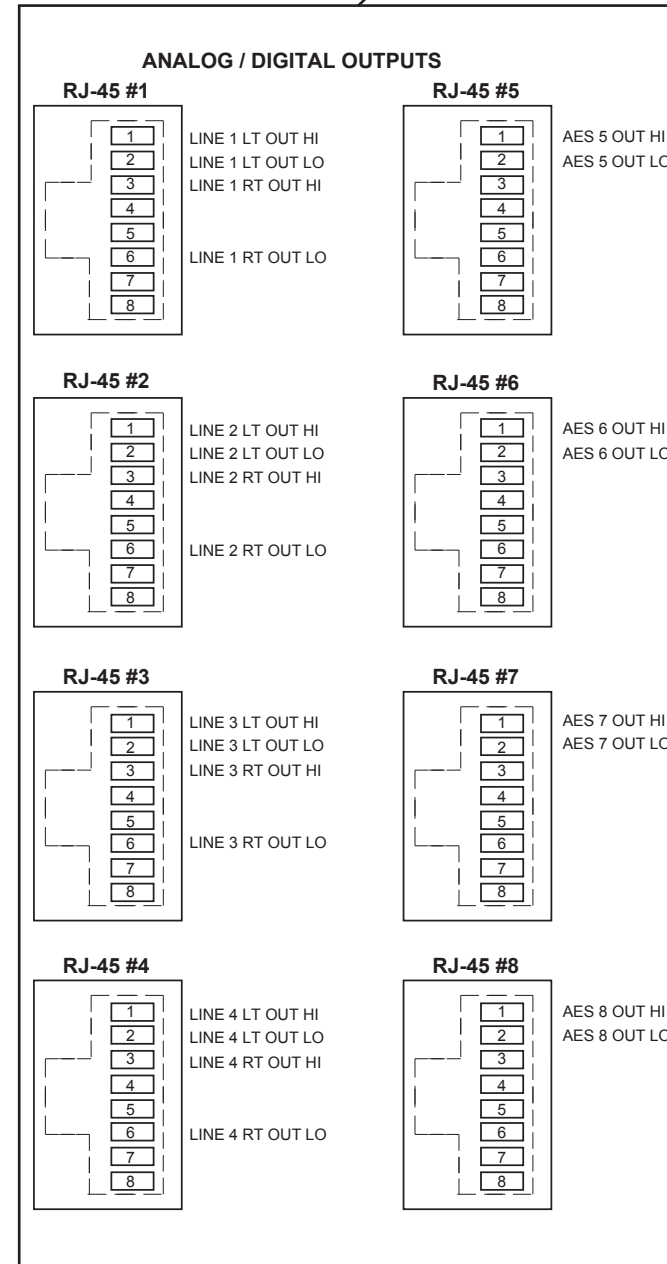
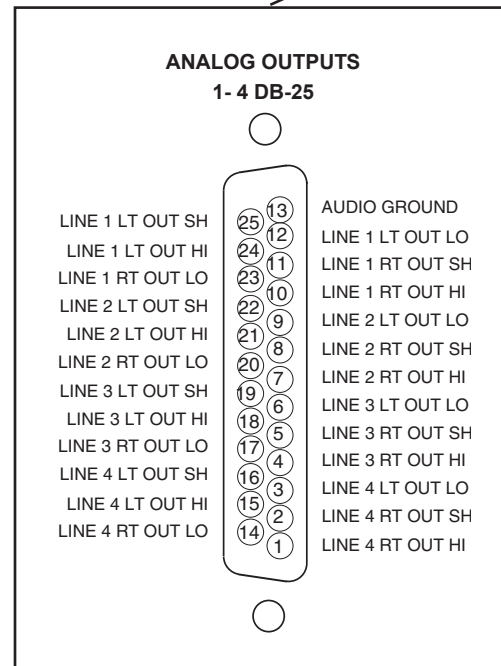
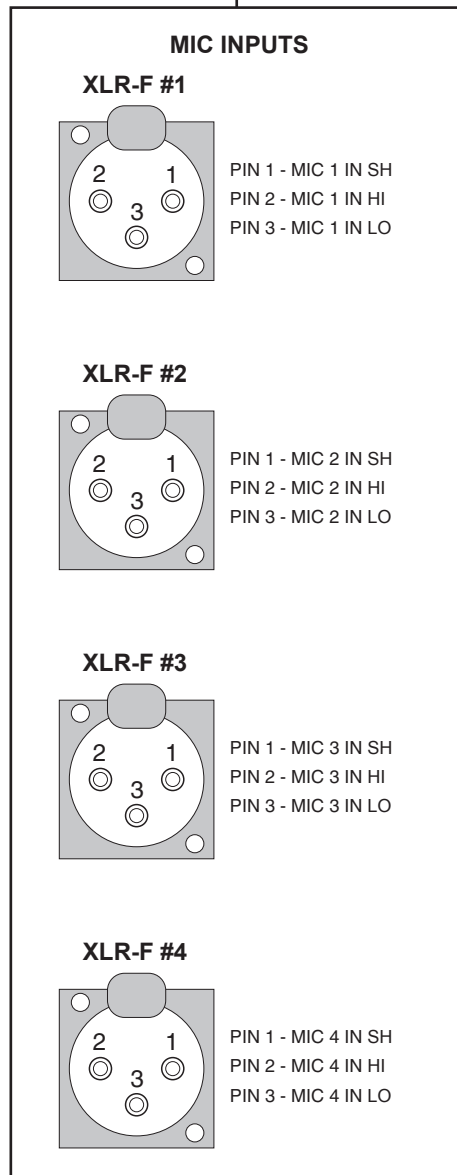

NOTE: DB-25 analog output connections and RJ-45 analog output connections are paralleled. Either may be used.

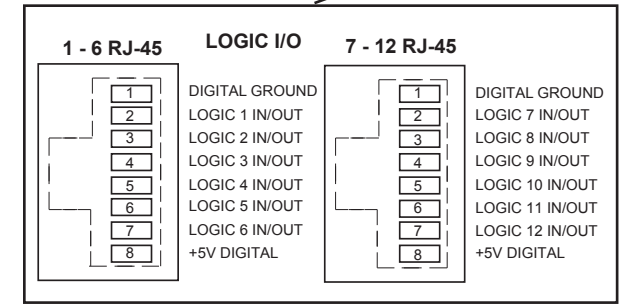
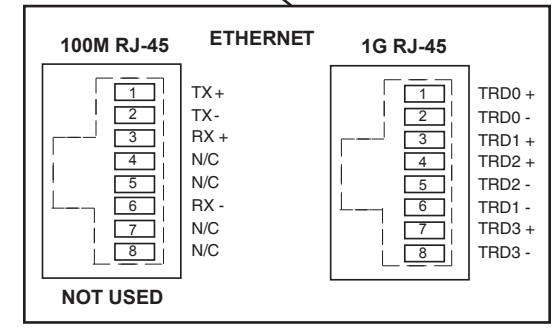
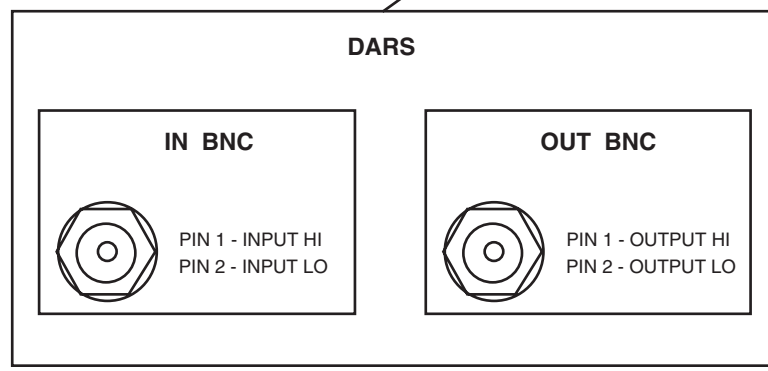
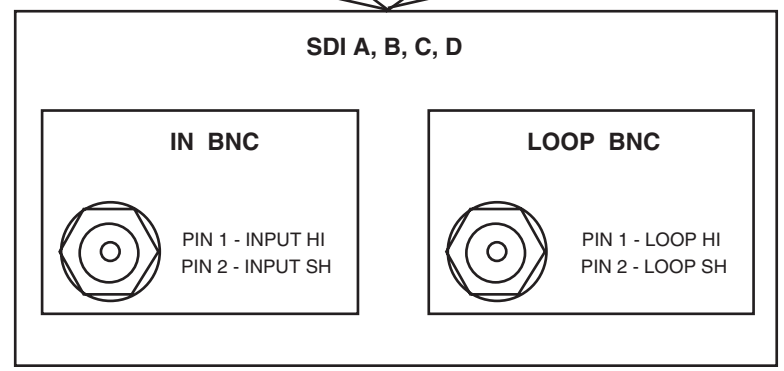

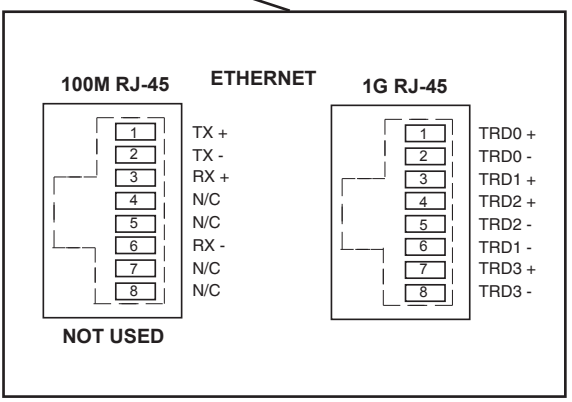
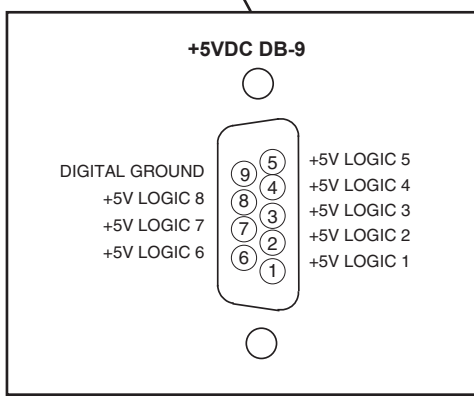
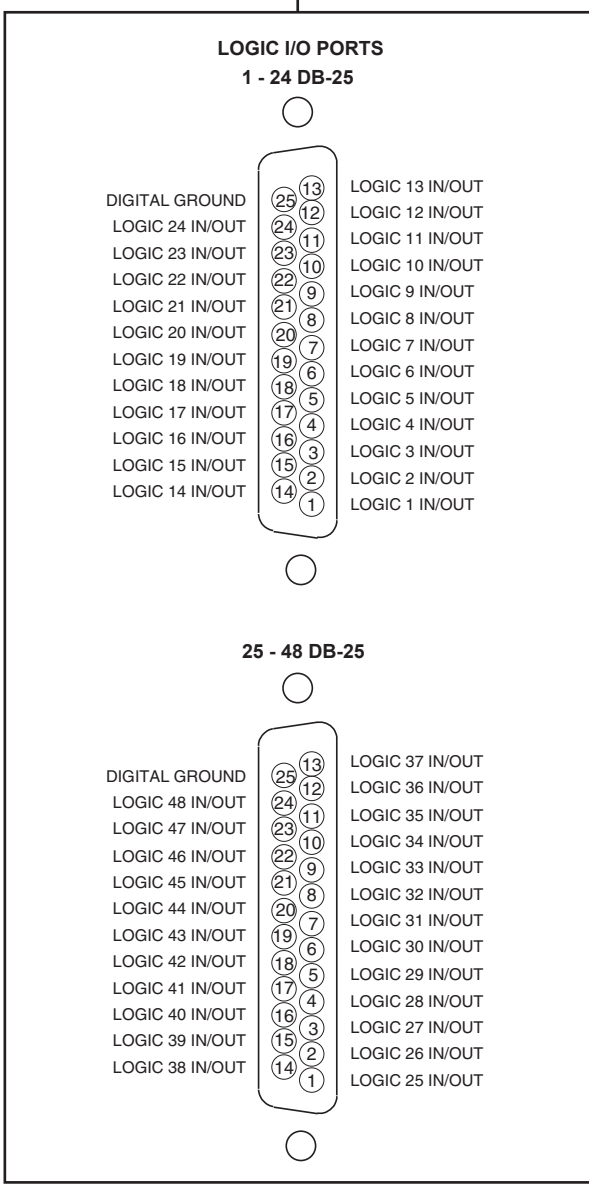
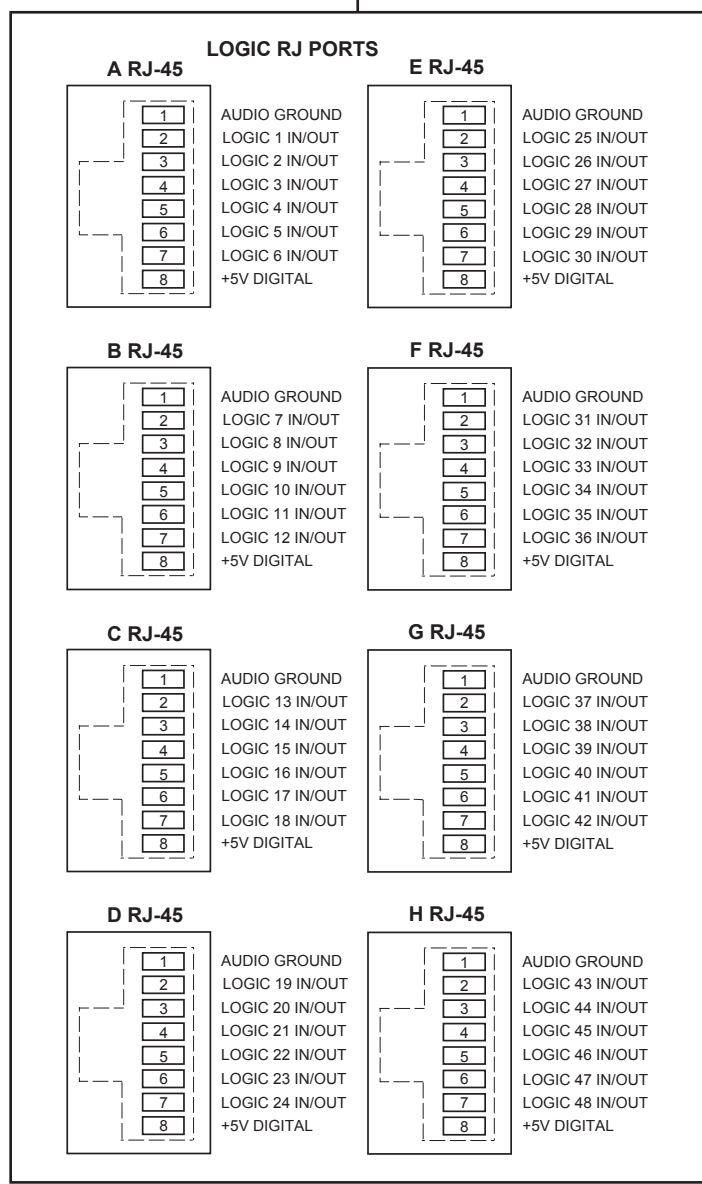

NOTE: DB-25 logic connections and RJ-45 logic connections are paralleled. Either may be used.

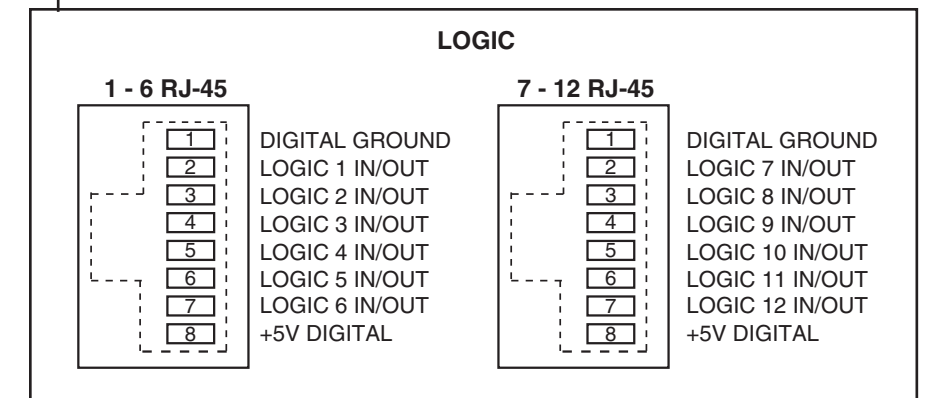
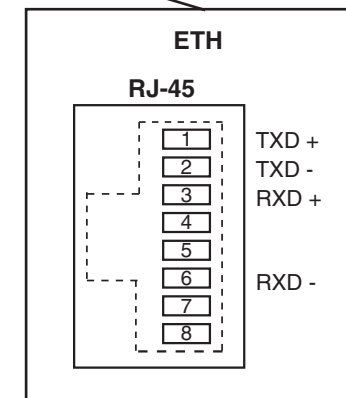
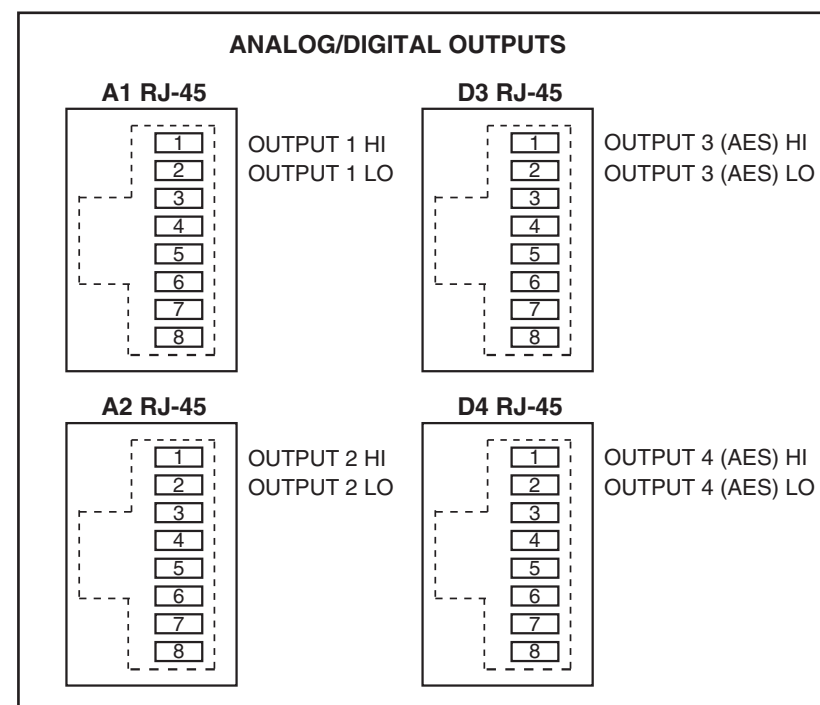
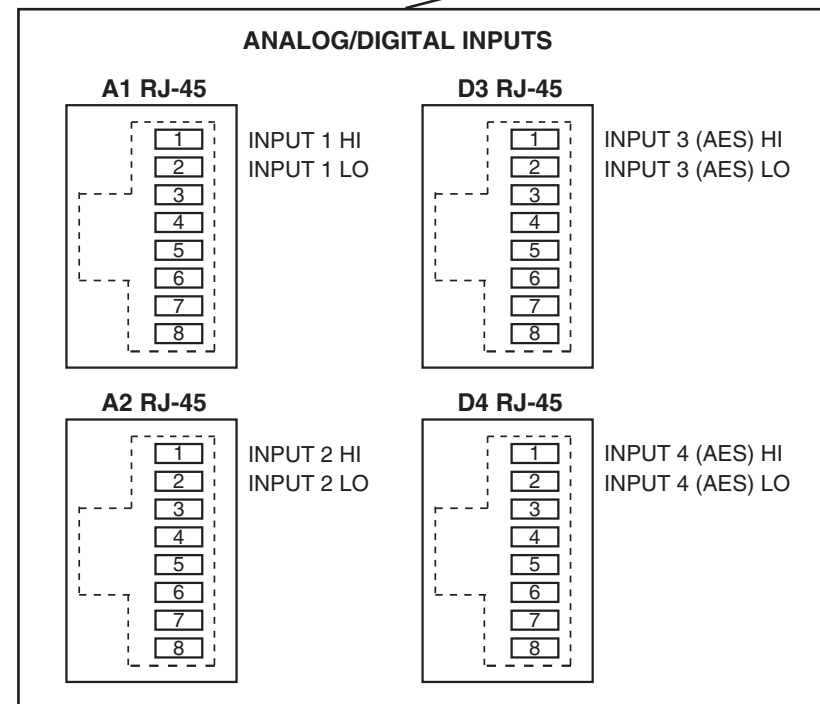
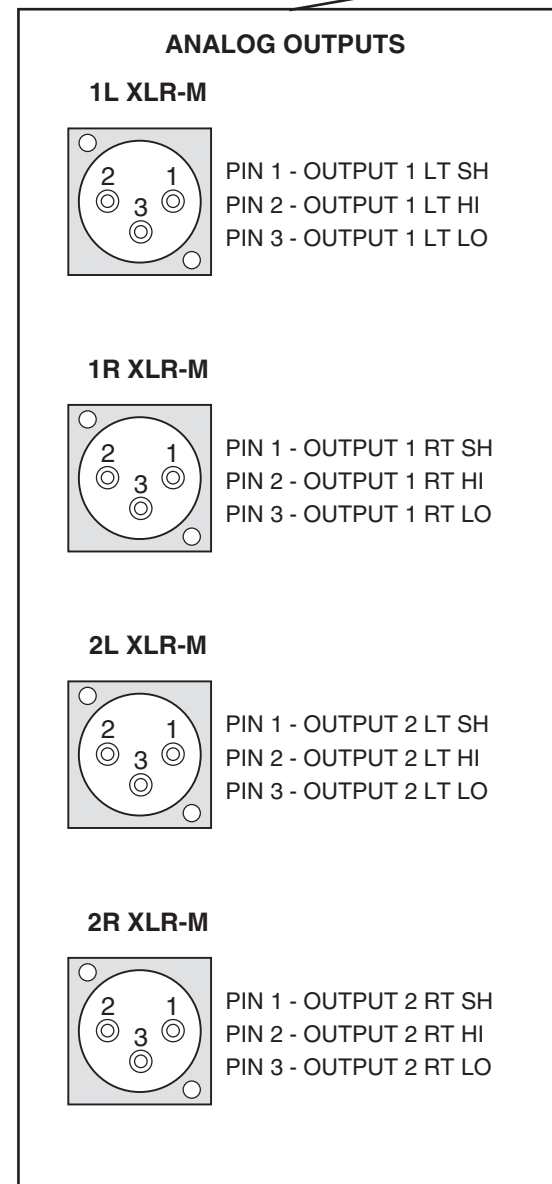
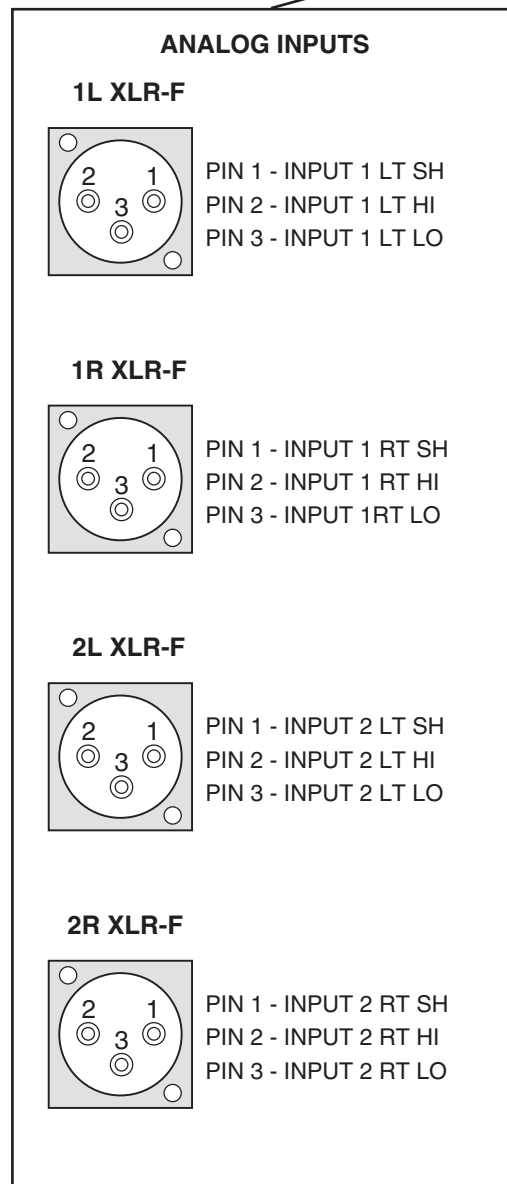

BLADE3 Setup and Configuration

Chapter Contents

BLADE3 Setup Mode.....	2-2
Front Panel Configuration	2-5
Front Panel Menu Diagram.....	2-7

BLADE3 Setup and Configuration



BLADE3 Setup Mode

As shipped from the factory, each BLADE 3 will initially start up in **Blade Setup** mode.

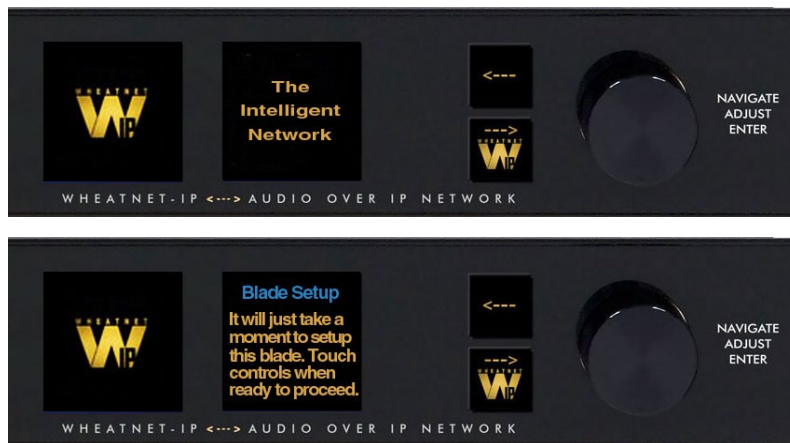

Activating any of the front panel controls will begin the setup process, during which you will be faced with a small number of choices, as indicated on the right side OLED display.

Your first decision involves “System Size” and is something that should be well thought out before doing **Blade Setup** on your first BLADE 3. Here are the three choices, and their significance:

- **1-99 Blades** – This would be your choice for a small to medium sized system. When you choose this size the setup wizard will automatically assign network settings to the BLADE 3 based on your choice of Blade ID (see below). IP addresses will be assigned within the 192.168.87.xxx subnet, with the last octet being assigned a value of 100 plus the Blade ID. The subnet mask will be set to 255.255.255.0, and the gateway will be set to 192.168.87.1. Once you have gone through the complete **Blade Setup** process you will be able to change the network settings, if desired. If you are setting up a system that you know will never grow beyond 99 BLADE 3 units, then this is your best choice.
- **100+ Blades** – This would be your choice for a large system. When you choose this size the setup wizard will automatically assign network settings to the BLADE 3 based on your choice of Blade ID. For IDs in the range of 1 to 99, IP addresses will be assigned within the 192.168.87.xxx subnet, with the last octet being assigned a value of 100 plus the Blade ID. The subnet mask will be set to 255.255.0.0, and the gateway will be set to 192.168.87.1. For IDs in the range of 100 to 199, IP addresses will be assigned within the 192.168.88.xxx subnet, with the last octet being assigned a value equal to the Blade ID. The subnet mask will be set to 255.255.0.0, and the gateway will be set to 192.168.88.1. Once you have gone through the complete **Blade**

Setup process you will be able to change the network settings, if desired. If you are setting up a system with more than 100 BLADE 3 units, or a system that you know will grow beyond 99 BLADE 3 units in the future, then this is your best choice.

- **Snake (2 Blades)** – This would only be your choice if, and only if, your system has exactly 2 BLADE 3 units, *and* you want them to act as a basic audio snake, routing audio from the first BLADE 3 inputs directly to the second BLADE 3 outputs, and *vice versa*, with no option to change the routing. In this case one BLADE 3 *must* be set up in the Snake sub-menu as **Snake A** and the other *must* be set up as **Snake B**.

Scroll the knob to the desired system size and click the right arrow button to accept that size. If you have chosen either **1-99 Blades** or **100+ Blades** you will then need to select a BLADE 3 Blade ID. Note that each BLADE 3 in the system must have a unique Blade ID. If you are choosing the **Snake** mode you will be asked to choose between **Snake A** and **Snake B**, as indicated above.

Once you have completed the decision process for system size, the setup wizard will display the settings on the right side OLED display. Press the right arrow button to advance to the next decision, that of **Default Sample Rate**. Here there are only two choices: **48K** (48kHz), or **44K** (44.1kHz). If you are not sure which one to select, and you are not working with audio for television, use **44K**. You can change the sample rate at a later time if needed. Scroll to the desired selection and press the right arrow button.

The final choice you need to make is which **I/O Template** to use. Here are the three choices, and their significance:

- **Stereo I/O** – This would be the most common choice if your facility consists primarily of equipment with stereo inputs and outputs, such as tape machines, CD players, computers, etc. When this template is employed the setup wizard will configure the inputs and outputs of the BLADE 3 as stereo signals and add these signals to the system. If you choose this template, you can later on change some of your signals to mono if necessary.
- **Mono I/O** – This would be the most common choice if your facility consists primarily of monophonic equipment, such as microphones, phone systems, etc. When this template is employed the setup wizard will configure the inputs and outputs of the BLADE 3 as mono signals and add these signals to the system. If you choose this template, you can later on change some of your signals to stereo if necessary. Please note that if you have a lot of mono sources you may be tempted to use this template, but you should also consider the rest of your audio equipment; you may actually still have more stereo signal requirements than mono ones.
- **Custom** – This would be a tempting choice if you have a fairly even balance between mono and stereo signals in your facility. However, if you choose this template the setup wizard will not configure the BLADE 3 inputs and outputs, nor will it add input and output signals to the system. With this template, you will need to create the signals for each input and output connection.

Once all the choices have been made, the setup wizard will complete the configuration process. The right side OLED display will indicate that the BLADE 3 is entering the system:



Once the BLADE 3 has joined the system its basic information will show on the OLED displays:



When the front panel controls are idle for a while the OLED displays will show the Screen Saver:



Front Panel Configuration



Activating any of the front panel controls will replace the screen saver display with the main menu screen.



Press the left arrow button  twice to open up the BLADE 3 information screens:

On the left window of the Info screens you will find your digital system clock rate, that can be either 44.1K, 48K, External Reference, or AES 67. The “Master” on the top row will be displayed if this BLADE 3 assumes the role as system master over the rest of the BLADE 3s in your network, or a square wave icon shows if this BLADE 3 is acting as the clock master. The BLADE 3’s Name, ID number, and inside temperature also display in this window. The RJ-45 connector icon will show green and have moving dots next to it if the BLADE 3 is connected to the network. If it is not connected the RJ-45 icon will show red and there will be no dots.



The right window of the Info screens displays whether the BLADE 3’s signal meters are displaying input or output, and also shows the BLADE 3 IP Address and Uptime.

Pressing the left arrow button again will take you back to the screen saver display.

Clockwise rotation of the knob navigates up and down a menu when there is a list, or scrolls thru options in a submenu once one has been selected. Pressing the right arrow button navigates through sub-menu options. Pushing the knob “takes” an option. 

To edit any parameter or name, press the right arrow button to highlight the parameter. Turn the knob to find the desired value or character, then press the right arrow button to take it. If the parameter has more than one field you can press the knob to cycle through the fields.

The  button backs out of a submenu to the main menu.

For example, when you select *Headphone...* by pressing the right arrow button the main menu list will be displayed in the left window and *Headphone Level* and *Connected Source* show in the right window.



To adjust the volume level, turn the knob to highlight *Headphone Level* and push the knob. You can then adjust the volume to a safe and comfortable level by turning the knob. Once complete, push the knob to exit the adjustment mode.

Press the  button to get back to the main menu.

For *Gain Levels...* select *Sources...* or *Destination...*



that brings up screens with list of sources (shown) or destinations and gain levels.



Try your hand at making some adjustments to help you get more familiar with the front panel controls.

The main menu of the BLADE 3 shows all of the options available from the front panel. These options are:

- **Headphone...** – Selects the headphone source and volume level.
- **Inputs...** – Sets the gain structure and phantom power (BLADE 3 Mic type only).
- **Blade...** – Displays current info of the BLADE 3, software and hardware version, external clock reference, and network settings. These settings can also be edited from this submenu.
- **Display...** – Sets the display's brightness and screen saver time
- **Gain Levels...** – Displays the gain levels for selected sources and destinations and allows the user to set the input level for each source and destination.
- **Utility Mixer...** – Each BLADE 3 has two Utility Mixers. Their features include panning, channel On/OFF, fader levels, and access to any source signal in the system. They also include a full ACI (Automation Control Interface) allowing remote control, ducking, auto fade, channel on/off, levels, source assign, etc.
- **Routing...** – Routes any audio input to any output or all outputs.
- **Status...** – Displays Uptime, Runtime, Date/Time, Temperature, ANNC Pkts/Errors, LIO Pkts/Errors, and GUI information, Surface availability (BLADE 3 Engine or Console types only), Route and Clock Master status.
- **Meters...** – Sets the front panel meter mode for BLADE 3 to show the input signal levels for each source or output signal levels for each destination.
- **Logic...** – Displays LIO Status and allows testing of the LIO outputs.
- **Password...** – Allows you to set a password to secure front panel access.

Front Panel Menu Diagram

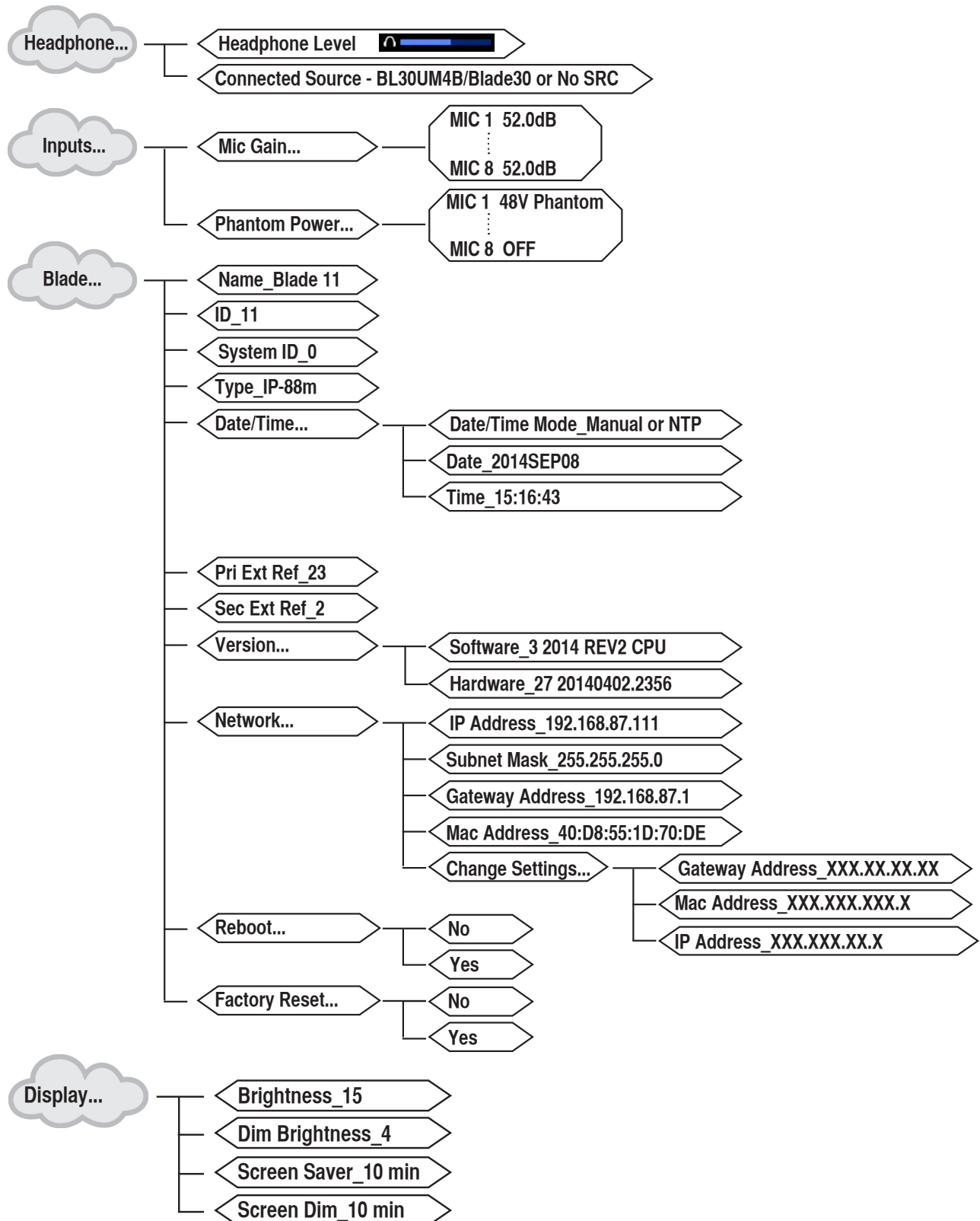

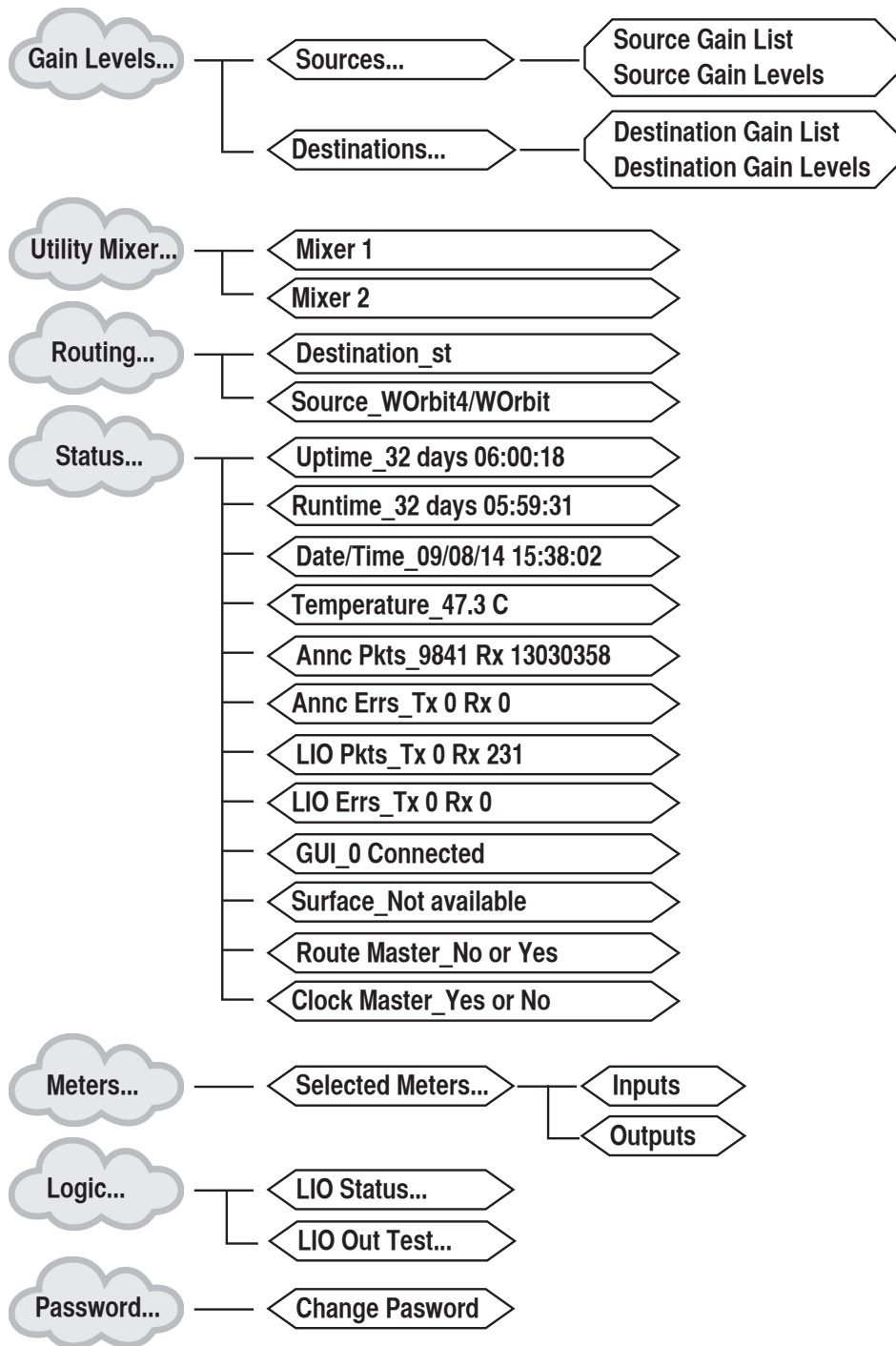

WheatNet-IP Networks

Chapter Contents

WheatNet-IP Networks and What They Do.....3-2

WheatNet-IP Networks

WheatNet-IP Networks and What They Do

What exactly is an “WheatNet-IP network?” Simply put, it is a collection of WheatNet-IP devices and driver equipped PCs connected together via an Ethernet LAN. In a WheatNet-IP network, each device is represented as a “BLADE 3” with a unique BLADE 3 ID. Each WheatNet-IP rackmount unit is a BLADE 3, each control surface rackmount engine is a BLADE 3, and even each driver equipped PC is a BLADE 3. The Navigator GUI gives a Windows Explorer style device tree system view showing all of the devices currently connected in the system.

You’ll notice in the example at the right that there are twelve WheatNet-IP rackmount units connected in this system, with IDs 1 - 12. You’ll notice 6 and 11 control surface engines, with the control surface at IPs 192.168.87.206 and 192.168.87.211 associated with them. Finally, you’ll notice PCs with IDs 95 and 97 connected as well; these are typically your Automation PCs, but in the WheatNet-IP system each is represented as a PC style BLADE 3.

This system tree view given by the Navigator GUI is a very handy tool for monitoring your system. It sure beats scrolling through a long list of names from the front panel of a BLADE 3. It will always show your system connection status. This is a very important point and indicates a big feature of the WheatNet-IP system. Every WheatNet-IP network system is dynamic. Devices can be added to it or removed from it at will, in real time, just like computers in your LAN. Creating and managing a LAN is beyond the scope of this manual, but a few things must be taken into account. First, the WheatNet-IP system uses fixed IP addresses for each BLADE 3, therefore your LAN must have the required IP addresses available. Second, the WheatNet-IP system comes configured with a default IP address scheme to make it easy to configure; the default addresses are 192.168.87.100 through 192.168.87.199, corresponding to BLADE ID=1 to BLADE ID=99. Third, to make sure that audio can be streamed throughout the network without disruption, the bandwidth and traffic patterns on the network must be carefully controlled. For these reasons, Wheatstone strongly recommends that the WheatNet-IP system and its various components be isolated (either physically or virtually) on its own LAN using the default IP addressing scheme. If this is done, a good sized WheatNet-IP system can be brought up and streaming audio in less than an hour.

As you add a WheatNet-IP device to the network (by plugging it in and assigning it a BLADE 3 ID) it’s associated signals are also automatically added and made available to the system. They will show up in the front panel displays of other BLADE 3s, and insert themselves into the crosspoint grid of the Navigator GUI. No complicated configuration or IP management is required; the BLADE 3s take care of it all for you.

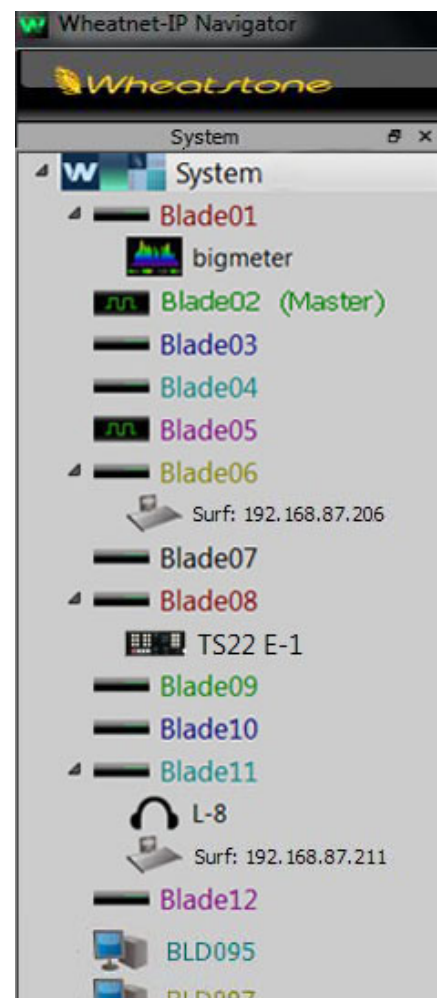

Should you need to remove a device (say because you want to borrow it to use elsewhere), no problem. Just unplug it from the network and it and its signals will automatically “disappear.” Later on, if you want to add it back in, again no problem. Just plug it back in and use the same BLADE 3 ID it previously had when it was in the system. It will reappear in the network with all of its old signal names, logic connections, silence detect settings, etc. The distributed intelligence of the WheatNet-IP system “knew” it was missing and reserved all of the information for when it came back. You don’t have to reconfigure anything.

So what does this WheatNet-IP network actually do? Actually, quite a lot of things. First and foremost, it transports audio from one device to another, or others. It matters not whether the devices are analog or digital, rackmount BLADE 3s or PCs or control surfaces. Once an audio signal is present in the system, it can be made to appear anywhere else with the scroll of a knob or the click of a mouse. That’s all there is to it; go to the destination you want the audio to appear at and click on the source channel you want to appear there and you’re done.

There are some purpose built extensions to this arrangement. Perhaps you would like a particular destination, say an airchain connection, to be protected from unauthorized connection changes. You can “lock” a connection so that it cannot be changed. Control surfaces automatically issue a temporary connection “lock” whenever a channel goes to the ON state or On Air, so someone doesn’t disconnect a source while it is playing out a program channel.

Locking a signal also “locks” any logic associated with the source signal to that particular destination. This can lead to undesired results if the source is taken to multiple destinations. The first destination connected typically will be only one to use the “logic” if assigned.

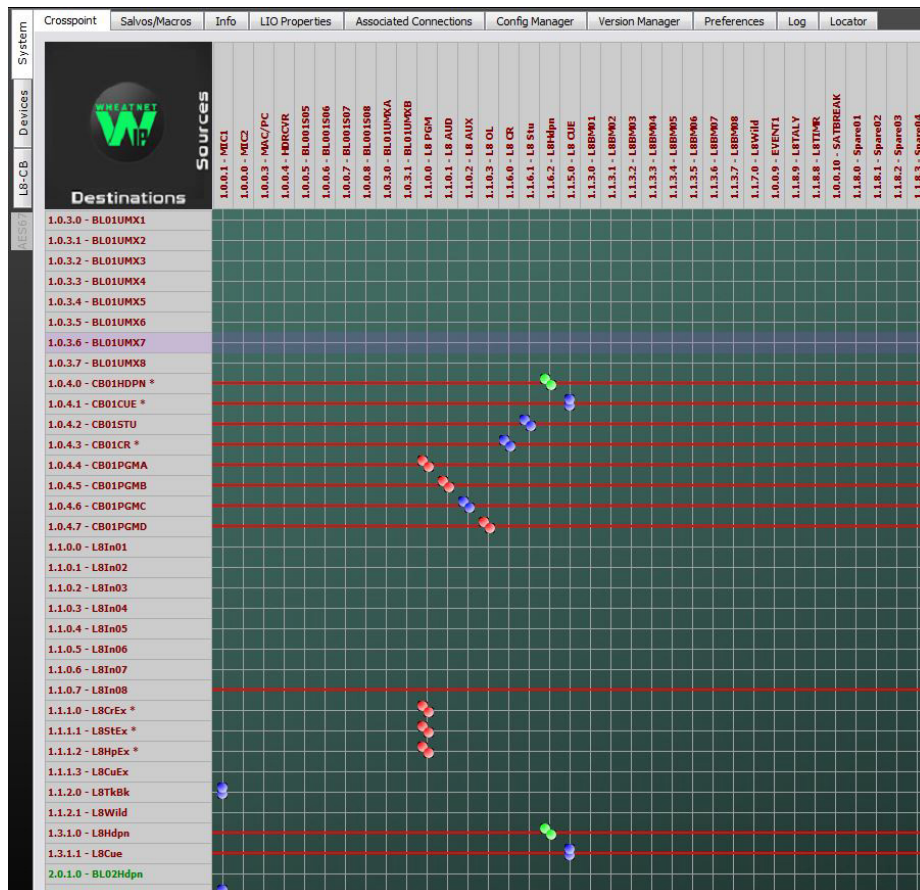

Maybe you want to restrict connection choices in some places. After all, a large system can have hundreds and hundreds of sources available. Why force your Air talent to scroll through hundreds and hundreds of names looking for the few choices he actually needs to have? You can create a “visibility” list so he sees only what you want him to. Each of the hundreds of destinations can have its own visibility settings.

Audio connections can also be combined into groups. We call these salvos. A salvo can be an assortment of up to 120 connections. Once defined, all of these multiple connection changes can be initiated with a single mouse click. These salvos can also be programmed to fire from logic connections or control surface buttons, making it easy to manage large changes. They can even be programmed to fire based on time of day from the Event Scheduler software.

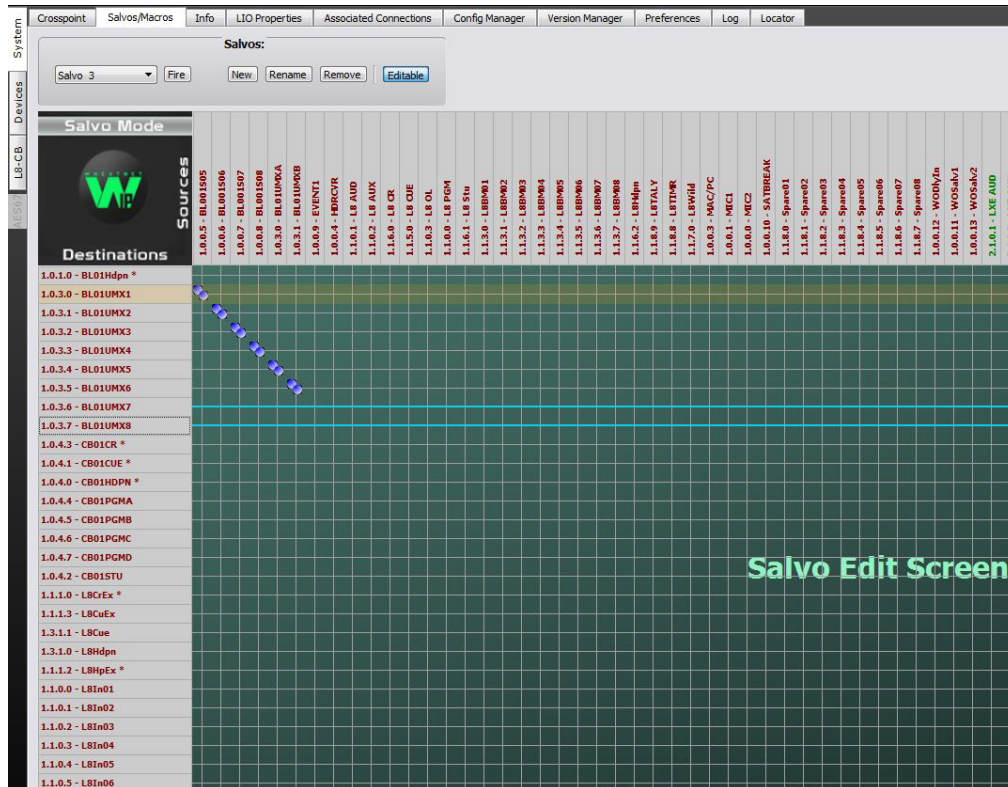
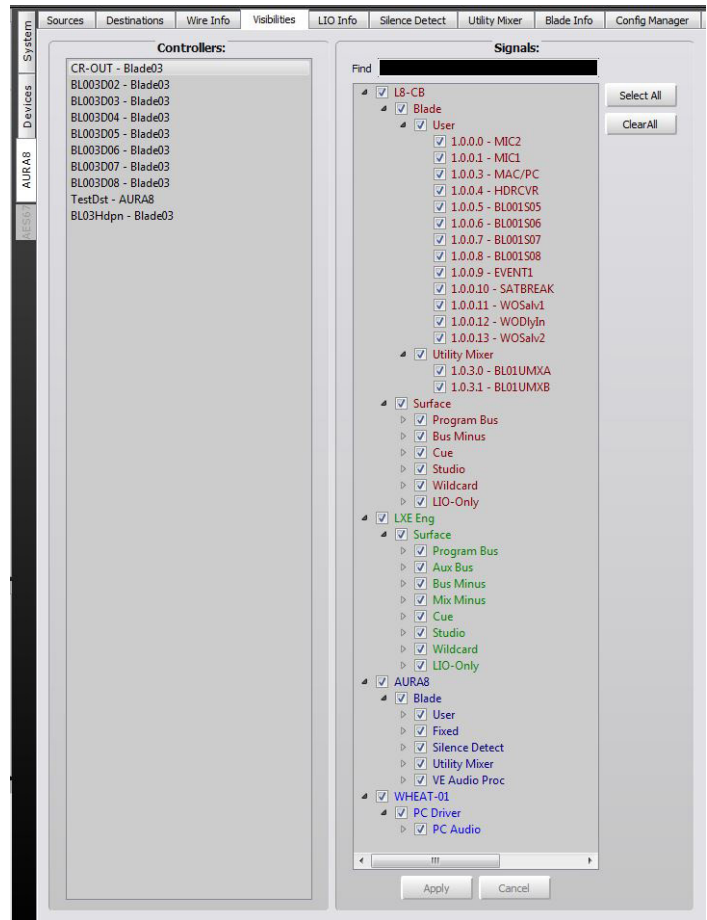

Audio connections can be mixed, or combined together. That's obviously what a control surface is for. You assign various sources to the fader channels (in the WheatNet-IP system, console fader channels appear as destinations just like physical outputs do)



and combine them into different buses and/or outputs, which can then be sent on to other destinations (again, in the WheatNet-IP system, all of the mix buses and console outputs appear as sources, just like physical inputs do). This is a huge advantage in system design, because you don't need to buy physical inputs or outputs for your consoles, nor do you need to buy distribution amps to get the same signal to multiple places. You need only one connection for each physical input or output device (say a microphone or speaker) and the WheatNet-IP network takes care of the rest.

But control surfaces aren't the only ways you can combine signals in the WheatNet-IP system. After all, a control surface can be a fairly expensive proposition if all you need to do is mix a few channels together. So each rackmount BLADE 3 includes two built Utility Mixers. Each mixer can select up to eight WheatNet-IP network sources, and provides two stereo buses which become available throughout the WheatNet-IP network. Each mixer channel has a separate fader for each bus output in the same mixer. The mixers are configured with the Navigator GUI, with the mixer inputs showing up in the crosspoint grid as destinations and the mixer bus outputs showing up as sources. And, for simple summing, such as combining the left and right channels of a stereo source into a mono destination, the WheatNet-IP system does that too.



What about when an audio connection goes bad? You'll be pleased to know that each physical output destination in each and every BLADE3 has the ability to automatically detect silence and, if need be, switch to an alternate source defined by you should the silence endure for longer than a specified period. Furthermore, it can be programmed to automatically switch back when the audio is restored. You can use this extensive capability to map out multiple levels of automatic failover to enhance your system's reliability. If a program output from a control room goes away, you can switch to an alternate. If a mix-minus feed to a remote drops out, you can feed him a back up. If your entire network goes down, you can have the BLADE 3 that feeds your air chain switch to a backup playback machine and start it playing. Because every output on every BLADE3 has this capability, you can layer as many levels of failover as you care to.

Consult the Navigator GUI section of this manual for specific details on audio signals, connections, salvos, mixing, and more.

There's more that the WheatNet-IP network can do besides transport audio. It can also transport logic changes. No modern broadcast facility can operate without logic control. This is what lights a warning light when a studio goes On-Air, mutes a speaker when a microphone turns on, starts a playback machine when a console button is pushed, or starts a recording when a relay is closed. The WheatNet-IP network transports logic change information between every BLADE 3, control surface, and PC that is attached to the system, via the same CAT6 LAN connection and Ethernet switch used for audio. You don't need to add anything. Each physical BLADE 3 has 12 general purpose logic connections that can be individually mapped as inputs or outputs. Each control surface has a number of automatically defined logic functions (Start, Stop, On, etc.) for each fader, as well as a number of programmable buttons and indicators, plus an assortment of mutes, tallies, and other functions. Between the jacks on the BLADE 3s for physical connections, plus all of the virtual ones on the control surfaces, just about any logic function you need can be accomplished. On top of that, Wheatstone can provide dedicated switch panels for host and talent locations, some of which contain their own scripting language for creating complex conditional logic configurations.

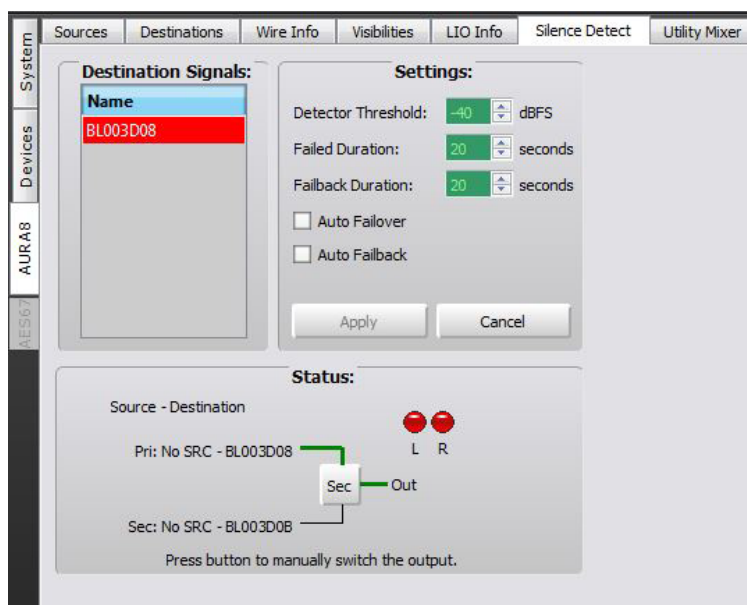

WheatNet-IP Rear



E-6 Surface



GP Turret

Logic functions in the WheatNet-IP system come in a number of different types. First there is the simple but direct self contained functions that are typically found in consoles and control surfaces. “If this mic channel is on then mute the control room output” and “if this channel is turned on then start the timer” are examples of direct logic. In the WheatNet-IP system, these functions and many more similar ones are programmed in the VDIP screens of the control surfaces.

A second type of logic in the WheatNet-IP system is audio associated logic. A “START” or “STOP” command for a playback device or an “ON” or “OFF” command for a microphone channel is an example of audio associated logic. What we mean by audio associated is that the particular logic function is “associated with,” or “belongs to” the audio signal being programmed. For instance, playback deck 1 of your Automation PC has a START command reserved only for deck 1, and playback deck 2 has a similar START command reserved for deck 2. If you make audio connections between these playback decks and faders 1 and 2 of a control surface, how can you use the buttons on the surface to activate the playback? In the WheatNet-IP system, audio channels can have these common

logic functions “associated” with the audio such that any other device (such as a control surface for instance) that has matching logic functions associated with it will allow the logic functions to work as long as there is a crosspoint connection (which is of course necessary for the audio to flow) between them. Audio associated logic is very powerful, because the “associations” take care of most of your common logic functions without lots of physical wired connections or undue programming. In the WheatNet-IP system, as many as 12 logic functions can be attached to each audio signal.

A third type of logic in the WheatNet-IP system is discrete logic. In this case you have some input device somewhere that needs to control some output device somewhere else. A profanity delay DUMP button is a good example. This is where the 12 physical logic connections on each BLADE 3 come in especially handy. In the WheatNet-IP system, you can create a special class of signal called “LIO

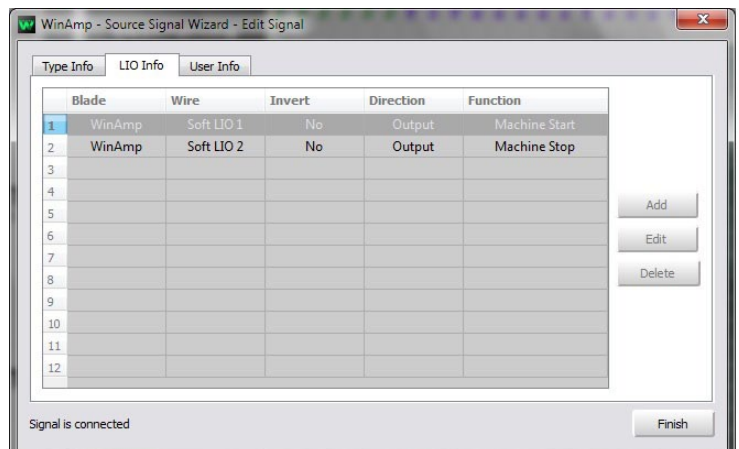
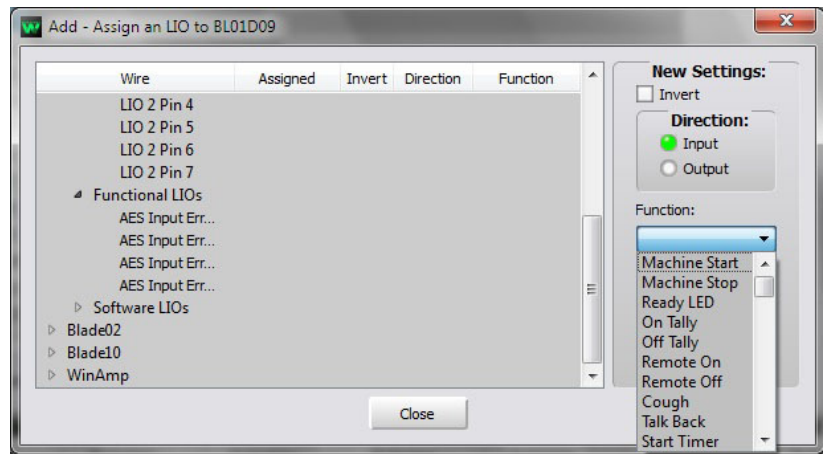
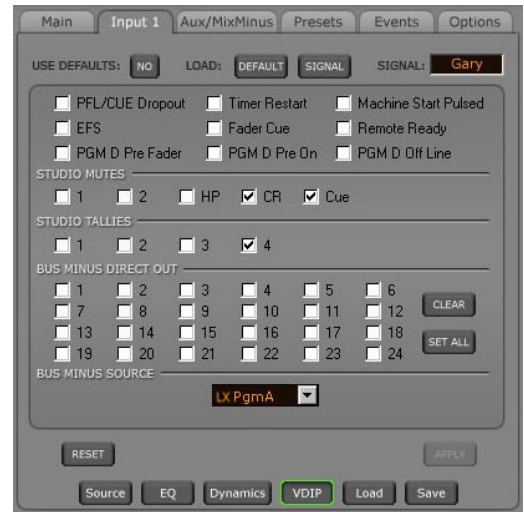

only.” These signals appear in the crosspoint matrix as logic “sources,” i.e. switches, and logic “destinations,” i.e. relays or indicators. When a logic source is cross connected to a logic destination, via the Navigator GUI for instance, then the logic state of the source will affect the logic state of the destination; the switch will fire the relay. No actual logic wiring between the switch and the relay is required, it all happens (with sub millisecond latency, by the way) over the LAN.

A fourth type of logic function in the WheatNet-IP system is called “action logic.” This is where you want some kind of system action to be controlled by a logic state. An example of this might be switches that are programmed to fire a salvo, or make a connection, or recall a control surface preset. Action logic is easily programmed with the Navigator GUI and is described in detail along with the other logic types in the GUI section of this manual.

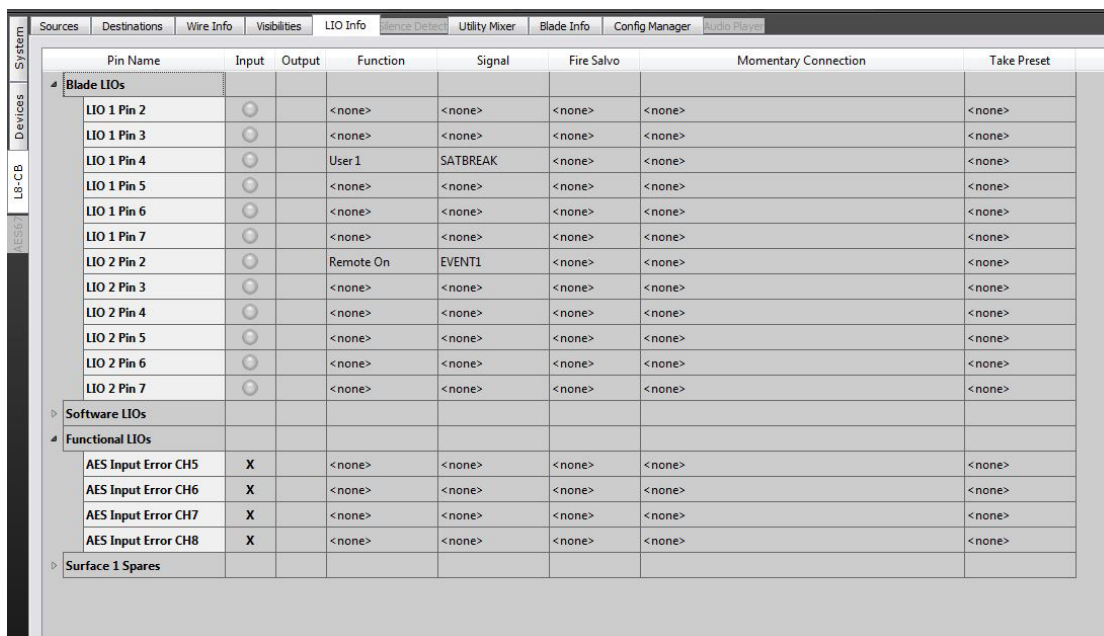

Pin Name	Input	Output	Function	Signal	Fire Salvo	Momentary Connection	Take Preset
Blade LIOs							
LIO 1 Pin 2	<input type="radio"/>		<none>	<none>	<none>	<none>	<none>
LIO 1 Pin 3	<input type="radio"/>		<none>	<none>	<none>	<none>	<none>
LIO 1 Pin 4	<input type="radio"/>		User 1	SATBREAK	<none>	<none>	<none>
LIO 1 Pin 5	<input type="radio"/>		<none>	<none>	<none>	<none>	<none>
LIO 1 Pin 6	<input type="radio"/>		<none>	<none>	<none>	<none>	<none>
LIO 1 Pin 7	<input type="radio"/>		<none>	<none>	<none>	<none>	<none>
LIO 2 Pin 2	<input type="radio"/>		Remote On	EVENT1	<none>	<none>	<none>
LIO 2 Pin 3	<input type="radio"/>		<none>	<none>	<none>	<none>	<none>
LIO 2 Pin 4	<input type="radio"/>		<none>	<none>	<none>	<none>	<none>
LIO 2 Pin 5	<input type="radio"/>		<none>	<none>	<none>	<none>	<none>
LIO 2 Pin 6	<input type="radio"/>		<none>	<none>	<none>	<none>	<none>
LIO 2 Pin 7	<input type="radio"/>		<none>	<none>	<none>	<none>	<none>
Software LIOs							
Functional LIOs							
AES Input Error CH5	X		<none>	<none>	<none>	<none>	<none>
AES Input Error CH6	X		<none>	<none>	<none>	<none>	<none>
AES Input Error CH7	X		<none>	<none>	<none>	<none>	<none>
AES Input Error CH8	X		<none>	<none>	<none>	<none>	<none>
Surface 1 Spares							

One of the most challenging parts of any logic system is getting it all right, making sure the senses, polarities, timing, and connections are all correct. In the WheatNet-IP system we provide a number of useful tools to help. First of all, logic pin outs, functions, and polarities can all be changed with a click of a mouse. You can also specify what you want a logic connection to do when it’s disconnected (go to a specific state or retain its last setting), and then change your mind about it later. Each logic input or output is fully independent and not linked into a scheme or template that uses them up needlessly. The physical logic connections on each BLADE3 are fully programmable; they can be all inputs, all outputs, or any combination. Changing them is simple via the Navigator GUI. The GUI provides on-screen indication of logic state changes so you can see that your buttons are actually triggering the right ports. The BLADE 3s themselves have a logic test display mode that will show the state changes on every logic input or output. They also have a front panel LOGIC PORTS indicators that show status for active logic and direction (in or out) of the BLADE 3. Best of all, the WheatNet-IP logic functionality is a completely integrated part of the WheatNet-IP system itself and does not require the Navigator GUI or any other PC to be running to make it work. The GUI is needed only for programming.

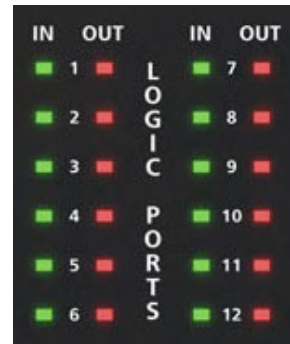

There is one last feature of a WheatNet-IP audio system that should be mentioned. Because WheatNet-IP is based on standard network models, the system has SNMP capability. Simple Network Management Protocol is a standard built into some networked devices to allow for a third party remote program to query them and retrieve important information regarding the status and operation of the networked devices. Depending on its complexity and set up, this remote program can acquire statistics, issue alarms, and even send email reports of the systems functionality. Consult the “Ethernet Networks and Switches” chapter of this manual for more information regarding the SNMP capability of WheatNet-IP systems.

The above descriptions of the functionality of the WheatNet-IP system are a brief overview of what it can do. For more details about these functions and others, please read the Navigator GUI section of this manual.

Ethernet Networks and Switches

Chapter Contents

Overview	4-2
Gigabit Ethernet Technology	4-2
Choosing Ethernet Switches	4-2
Switch Feature Considerations	4-2
Unmanaged vs. Managed Switches.....	4-3
Rules of Thumb	4-3
What's on the Wire?	4-4
Designing the WheatNet-IP Network	4-5
Where to Start	4-5
Cabling	4-5
GbE Network Cabling Guidelines.....	4-6
1000BASE-T vs. 1000BASE-TX	4-6
Wireless Connectivity	4-6
Configuring the Network	4-6
Managed Switch Configuration.....	4-6
Default LAN Parameters.....	4-6
BLADE3 Configuration	4-7
Surface Configuration	4-8
PC Configuration	4-10
Network Interface Card (NIC)	4-10
Typical Small Network Block Diagram	4-11
Typical Medium Network Block Diagram	4-12
Typical Large Network Block Diagram	4-13
Network Troubleshooting	4-14
Useful ICMP Commands.....	4-14
Software Tools.....	4-14
Simple Network Management Protocol (SNMP)	4-14
Hardware Status Indicators.....	4-15
Error Logs.....	4-15
PC GUI Log	4-15
Alarms	4-16

Ethernet Networks and Switches

Overview

The underlying network plays a major role in the successful deployment of your WheatNet-IP system. In the IP audio world, the Ethernet network is the analog of the punch block wall in a traditional broadcast plant. As such, careful consideration should be given to network topology when planning the installation. Because the size and type of network you design and deploy directly depends on the amount of WheatNet-IP and surface hardware you are installing, it is wise to build a network that has reasonable overhead and room to grow as formats and audio distribution needs change over time.

Gigabit Ethernet Technology

The WheatNet-IP system uses 1000BASE-T gigabit Ethernet technology exclusively to transport audio and control packets between BLADE3s. Because the WheatNet-IP system uses gigabit connectivity, the possibility of link overload is drastically reduced when compared to competing 100BASE-TX systems. Each Gigabit connection is capable of handling literally hundreds of audio streams, along with associated GPIO, system configuration, and network monitoring capabilities. Advantageously, the cost of gigabit technology is rapidly decreasing due to economy of scale benefits gained by cross application use of the technology.

Choosing Ethernet Switches

There are literally hundreds of choices of Ethernet switches on the market today. Chances are you have a compatible switch in your facility already. However it is recommended that the WheatNet-IP network be isolated from any existing network using separate switches or a unique VLAN on existing switches.

Switch Feature Considerations

- **10/100/1000 Ports** – When looking at switches, make sure all the ports support full-duplex 1000BASE-T connections. Some switch models are touted as Gigabit, but really only have one or two 1000BASE-T ports.
- **Hubs** – Packets entering a hub or repeater are broadcast out of every other port on the device. Gigabit hubs must be avoided because they are a single collision domain and can slow your GbE audio network to a crawl. If you find a really good deal on a Gigabit “switch” be sure it is not really a hub.
- **Throughput** – Is an important specification when deciding on a Gigabit switch. Throughput is the amount of cumulative data traffic a switch is capable of transceiving. Ideally an eight port 1000BASE-T switch should incorporate an 8Gbps non-blocking switch fabric. Low throughput switches typically use input buffering techniques susceptible to Head-Of-Line blocking which can adversely affect the real time performance of medium to large IP audio networks.
- **Rack Mounting** – Rack mounting is a useful option for most broadcast systems.
- **Chassis Based** – Large enterprise systems may benefit from installing or expanding existing chassis based managed switch solutions.

Unmanaged vs. Managed Switches

An unmanaged Ethernet switch is a low cost WYSIWYG device and has no configuration software interface. Unmanaged switches do not support IGMP snooping and will therefore act as repeaters to IP audio multicast packets, effectively flooding all ports with audio packet traffic. Unmanaged switches are inexpensive, acceptable cost vs. performance compromise.

Managed switches, on the other hand, allow users to configure the switch hardware with a software interface of some kind, such as Telnet, Web, Terminal, etc. Primary configuration features applicable to your Ethernet audio network are the ability to configure VLAN's, IGMP management, built in diagnostics, and routing. We highly recommend the deployment of managed switches throughout the network.

Managed switches fall in to several market niches. Low end managed switches, or "Smart Switches," offer some configuration, but may not provide the level of configurability required in a medium to large Ethernet audio network. For example, these switches may forward IGMP host messages and multicast traffic but can not act as the IGMP router. In medium to large applications at least one switch capable of being the IGMP Querier is required. Mid-priced managed switches are better suited to the task and will provide more configuration flexibility.

In larger systems it makes sense to employ a "core and edge" model. This type of system balances the switching horsepower (cost) according to the throughput requirements at different physical segments of the network. Lighter bandwidth "edge" segments can use lower cost switches, while central rack room "core" segments utilize higher performance devices.

Rules of Thumb

The WheatNet-IP system will work with a minimum number of devices on an unmanaged switch. If the system is to include more than six BLADE3s, two Control Surfaces, and two PC drivers it is recommended that an IGMP compliant, managed switch be used.

In large systems, careful attention must be paid to the placement of core and edge switches.

- Each I/O (88a, 88d, 88ad) BLADE 3 requires 36.9Mb/s for eight Stereo connections.
- Each I/O (88a, 88d, 88ad) BLADE 3 Requires 73.7Mb/s for 16 Mono connections.
- Each Engine (e) requires 147.5Mb/s for 32 unique stereo connection streams.
- Each E-6 surface requires a 100Mb/s Ethernet connection.
- Each Surface requires an Engine (e) connected to the same GbE switch.
- Each PC driver requires 19.6Mb/s for eight Stereo outputs.
- An aggregate of eight BLADE3s (64 streams) requires roughly 295Mb/s of bandwidth when each BLADE3 have eight stereo connections.

The Multicast channels used by the WheatNet-IP System are as follows:

- one per audio source
- one for system announce messages
- one for metering data
- one for Logic messages.

What's on the Wire?

The WheatNet-IP system uses the standard 1000BASE-T gigabit Ethernet hardware infrastructure to distribute audio, logic, and control over copper UTP CAT5e or CAT6 cable. Because the WheatNet-IP system uses a standard, non-proprietary Ethernet network for connecting devices, the digital audio network supports the universal suite of Ethernet protocols, including TCP/IP, HTTP, FTP, Telnet, SNMP, RTP, IGMP, etc.

The WheatNet-IP system software utilizes RFC standards initially developed for VoIP applications to synchronize and distribute packetized audio between BLADE 3s (nodes), control surface processing, and PC's. Specifically, the Internet Group Management Protocol (IGMP) is used to manage the distribution of multicast audio packets, which are integral to WheatNet-IP design.

Designing the WheatNet-IP Network

Where to Start

Before you buy any network equipment, it may be beneficial to sketch out or formally draw a block diagram of your system. A few typical system block diagrams are included later in this chapter for your reference. Note the number of Ethernet ports required, wire length estimates, potential Ethernet switch locations as well as the number of BLADE 3s, PC drivers, and control surfaces. Remember this exercise is intended to give you a general idea on what physical topology might work best in your facility so it is probably best not to get bogged down in the details. This information will also help guide you in network hardware purchasing decisions.

Many small Ethernet audio network applications may be assembled without much preparation or difficulty while medium to large systems will require careful planning to eliminate potential bottlenecks. When designing your Ethernet audio network it is useful to consider the following parameters:

- **Scope** – Does the network design meet current interconnectivity requirements?
- **Physical Infrastructure** – Topology, switch placement, CAT5e/CAT6 cabling.
- **Throughput** – Is there enough switching throughput?
- **Headroom** – Is there room for growth built into the network?
- **Applications** – Will this be an audio only or shared use network?
- **Serviceability** – What is the maintenance plan?
- **Monitoring** – What network monitoring software tools are required?
- **Remote Access** – Is there a secure path to remotely monitor or troubleshoot the network?

Cabling

The wiring requirements for the WheatNet-IP system follow the specifications for 1000BASE-T set forth in IEEE 802.3ab. That specification calls for UTP CAT5e or CAT6 cabling, jacks, and patch cables to be used throughout the network. When wiring with CAT6 cable, use CAT6 rated RJ-45 connectors that are designed to accommodate the thicker wire insulation. Note that unlike common 1000BASE-T/100BASE-TX Ethernet networks, the 1000BASE-T gigabit networks use all four twisted pairs inside the cable. This specification requirement makes the system less tolerant of problems stemming from sub-standard wiring installation. Because Auto-negotiation is part of the 1000BASE-T specification either straight or crossover cabling may be used. We recommend that all cables be wired identically simply to avoid potential confusion.

One often overlooked but critical step in the installation of Ethernet networks is Certification. Poor installation methods can easily degrade your CAT6 cabling into CAT3 performance. It is recommended that all Ethernet audio network cable runs and patch cords be certified onsite to confirm that wiring patterns, bandwidth, and cable length all meet specifications. This relatively easy but important step gives you peace of mind and can save hours of troubleshooting time chasing connectivity and bandwidth problems.

GbE Network Cabling Guidelines

- 1000BASE-T Standard – All four twisted pairs are used.
- Use UTP CAT5e or CAT6 cable exclusively.
- Use the correct connectors for the cable type.
- Certify all end to end runs and patch cables.
- 100M (328ft) port to port distance limit.
- Auto-MDI/MDI-X supported on GbE switches.
- CAT6 crossover wiring pattern differs from CAT5.
- Switches may be linked with fiber using GBIC modules.

1000BASE-T vs. 1000BASE-TX

Note that these very similarly named standards specify different wiring methods. The prevailing Gigabit Ethernet 1000BASE-T standard uses all four pairs of wire, while the outdated 1000BASE-TX standard uses only two pairs. To add to the confusion some products marketed as 1000BASE-TX may actually be 1000BASE-T designs.

Wireless Connectivity

Wireless routers of the 802.11ab/g/n variety are currently not up to the task of reliably distributing multicast audio at the data rates required by the system. A wireless access point could be added to the network for administration, monitoring, or remote access purposes.

Configuring the Network

The WheatNet-IP system is very friendly when it comes to network configuration. By default, BLADE 3s will configure their IP Address and Multicast parameters automatically based on the BLADE 3 ID number. This auto-configuration method is similar to the Dynamic Host Configuration Protocol (DHCP) used on many Ethernet networks to configure PC wired and wireless NIC's on power up. A provision for user override of this functionality is provided for customers wishing to manually configure their network.

Configuring your WheatNet-IP network breaks down into four categories:

- Managed Switch configuration
- BLADE 3 configuration
- Surface configuration
- PC Configuration

Managed Switch Configuration

At first glance, the number of configuration options for a managed switch can be overwhelming. Luckily, there are only a few parameters that need to be configured on the managed switch to set it up for WheatNet-IP multicast traffic.

Default LAN Parameters

- IP Address Settings – Set the IP address of the core switch or WheatNet-IP VLAN to 192.168.87.1.
- Stacking switches – Give each subsequent switch an IP address on the same subnet.

- VLAN's – Modern managed switches allow the user to segment any number of ports into a VLAN or Virtual Local Area Network. This collection of ports is identified by a static base IP address and Subnet mask and, more importantly, constitutes a discrete Broadcast Domain. Segmenting a network into discrete Broadcast Domains allows you to control which ports send and receive the Multicast audio packets. VLAN's may be segmented across multiple managed switches connected to the core switch. Most switches that are capable of VLANs come out of the box with a default VLAN configured. You must assign an IP address to the default VLAN. For Sample Configuration Refer to the “*Configuring a Cisco 2960*” section in the Appendix 2.
- IGMP – IGMP will need to be enabled on the switches or VLAN's designated for the WheatNet-IP system. Settings may vary among switch manufacturers. When configuring Standard and Advanced IP services always refer to the switch documentation for setup specifics. For Sample Configuration Refer to the “*Configuring a Cisco 2960*” section in the Appendix 2.
- Spanning – Tree Portfast – It is recommended that Portfast be enabled only on switch ports connecting to a single BLADE 3. This allows the BLADE 3 to join the network immediately on power up, bypassing the listen and learn states.

Note: If you enable Portfast on a port connecting another network device such as a switch, you can create network loops. Use Caution when enabling Portfast.

BLADE 3 Configuration

The Quick Start Guide provides details on quickly setting up a BLADE 3. Note that some of the parameters listed below will automatically be created based on the BLADE 3 ID number you enter.

Important! Before you plug the BLADE 3 into the Network, set a unique BLADE 3 ID.

The following parameters must be configured on a BLADE 3.

- BLADE 3 ID number – This device number must be selected and entered by the user on each BLADE 3 in order to uniquely identify the BLADE 3 in the system.
- IP addressing – All WheatNet-IP devices use dynamic IP addressing based on their BLADE 3 ID number. Each device is given an IP address in the 192.168.87.xxx scheme, starting at .101 for the box with BLADE 3 ID 1 and so on.
- You can override the automatic setup and have full control over IP addressing.
- Subnet Mask – The default 255.255.255.0 subnet mask will work in most systems. This allows for 254 devices on the audio network.
- Gateways – Gateways may be employed for remote access and routing purposes.
- Ports – The system uses the following TCP/IP Ports - See Table on next page.

PORT	PURPOSE
23000	Telnet to Play Service
50000	GUI Connect
50100	Metronome Multicast Stream
51000	Web/XML Multicast Stream
52000	Announce Channel Multicast Stream
52001	Logged Channel Multicast Stream
52002	Meter Multicast Stream
55776	Automation Control Interface
60000	Surface Channel

Surface Configuration

Surface configuration is very easy using a mouse and VGA monitor connected directly to the control surface. When first powered up, a surface will ask you to configure its network parameters.



To configure the network settings for the surface select “YES” from the dialog box. The surface will now display the Options Tab’s Network Settings screen, where you will set the Mix Engine ID and IP address of the Engine to which

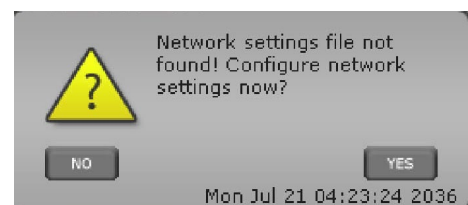

the surface will connect, along with the Surface IP Address (on the default 192.168.87.xxx scheme), Subnet Mask, and Gateway.



If Automatic mode is selected, enter the Mix Engine ID of the WheatNet-IP Mix Engine to be associated with the surface and remaining settings are configured for you. You can manually enter this information by pressing the Manual button and using the numbered keypad on the screen. Pressing NEXT will advance to the next field.

For convenience, Wheatstone uses the following convention for IP Addressing in the WheatNet-IP system:

1. The IP Address of a BLADE3 is equal to the BLADE3 ID plus 100; i.e., BLADE3 3 = 192.168.87.103
2. The IP Address of an E-6 control surface is equal to the Engine BLADE3 ID plus 200; i.e., Engine BLADE3 = 5, Surface IP Address = 192.168.87.205

When done simply press APPLY to finalize these settings and the surface will request a reboot.

Select YES from the dialog box and the surface will reboot.



Once the surface has been rebooted navigate to the Options Tab and select Network Settings from the drop down menu. If all information was entered properly the BLADE3 STATUS will display “CONNECTED.” The surface has been successfully configured.



PC Configuration

The WheatNet-IP PC Driver is a WDM driver that supports up to eight Stereo Output and eight Stereo Input streams. The driver eliminates the need for expensive sound cards. Each driver Output/Input is displayed in Windows as a unique sound device and can be controlled using the Windows mixer or any audio application that accesses sound cards.

Driver Installation – The driver may be installed on any Windows PC running Windows XP Service Pack 2 and higher. Please refer to the Appendix 5 of the manual for detailed installation and configuration information.

Network Interface Card (NIC)

It is recommended that a multi-home connection method be used on PCs that need to be connected to an office LAN while also connecting to the WheatNet-IP network. This will require a second NIC in the PC. There are many types of Network Interface Card on the market. While many of them may work for this application there may be some that do not perform well under such demanding conditions. Intel and Broadcom cards perform very well in this environment.

There are a few settings that can help improve the performance of many of the available cards:

- Disable Windows Power management on the Interface card.
- Set the Speed and Duplex to Auto negotiate (Default).
- Disable the Windows firewall.

Typical Small Network Block Diagram

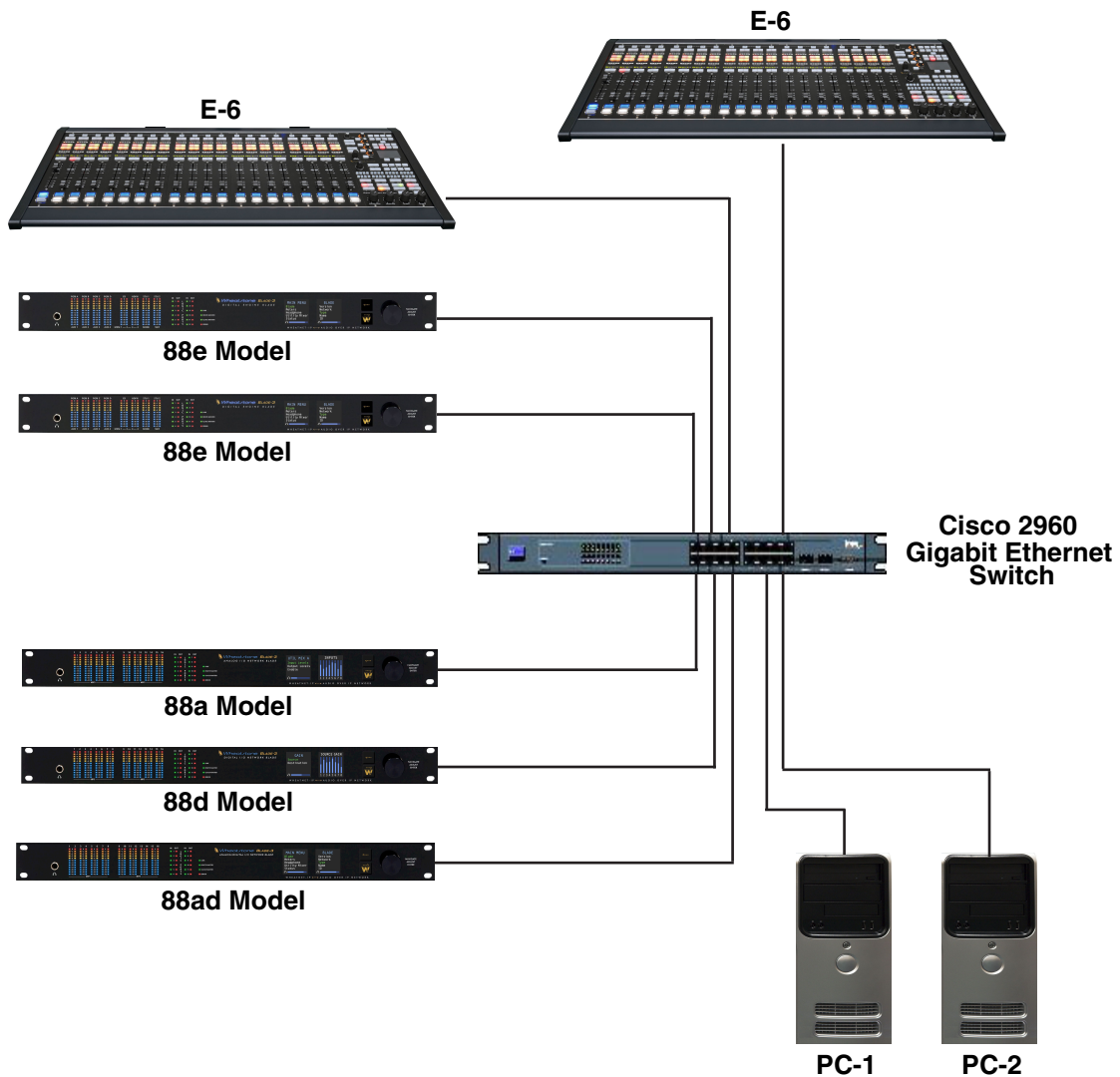

Typical Medium Network Block Diagram

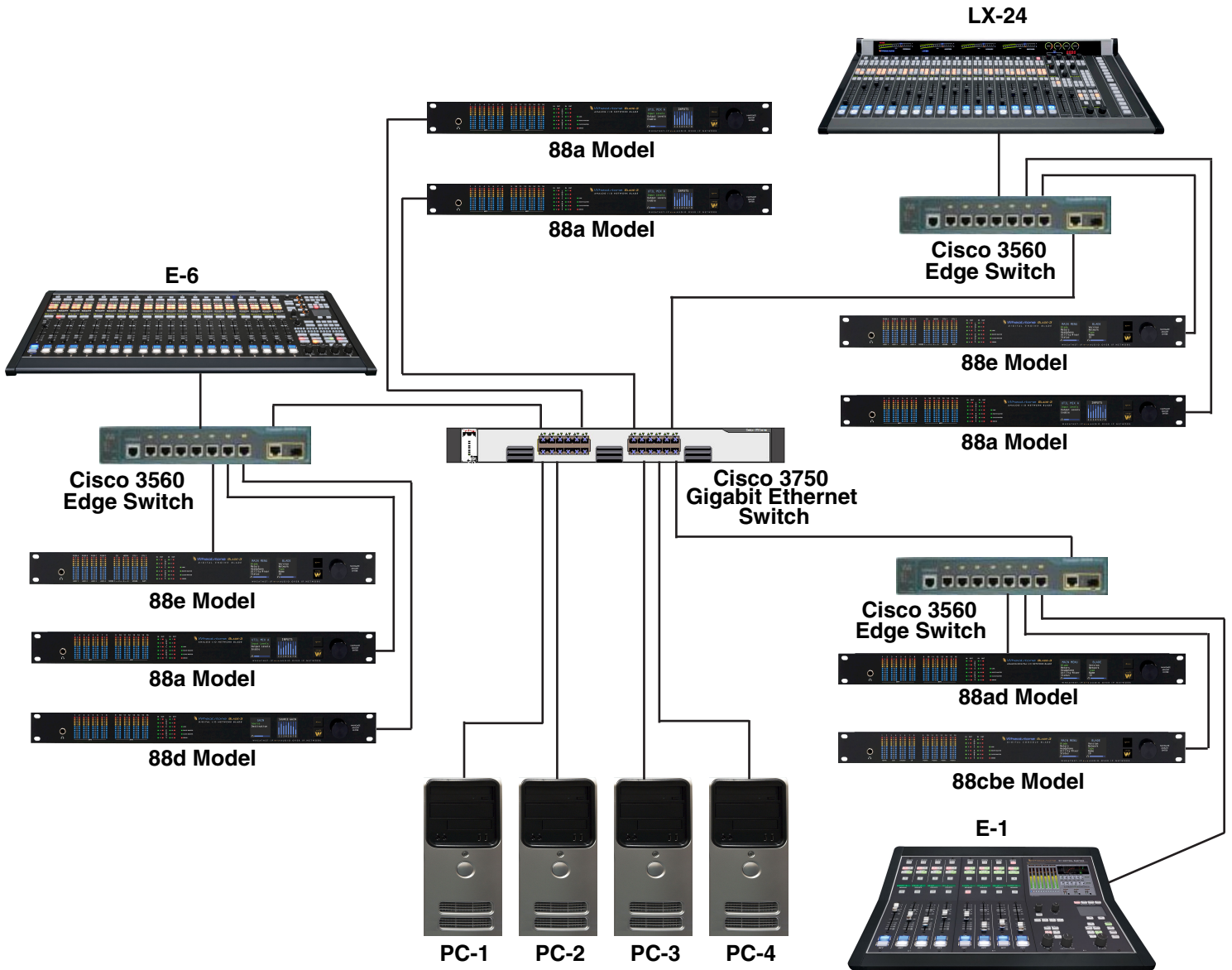

Typical Large Network Block Diagram

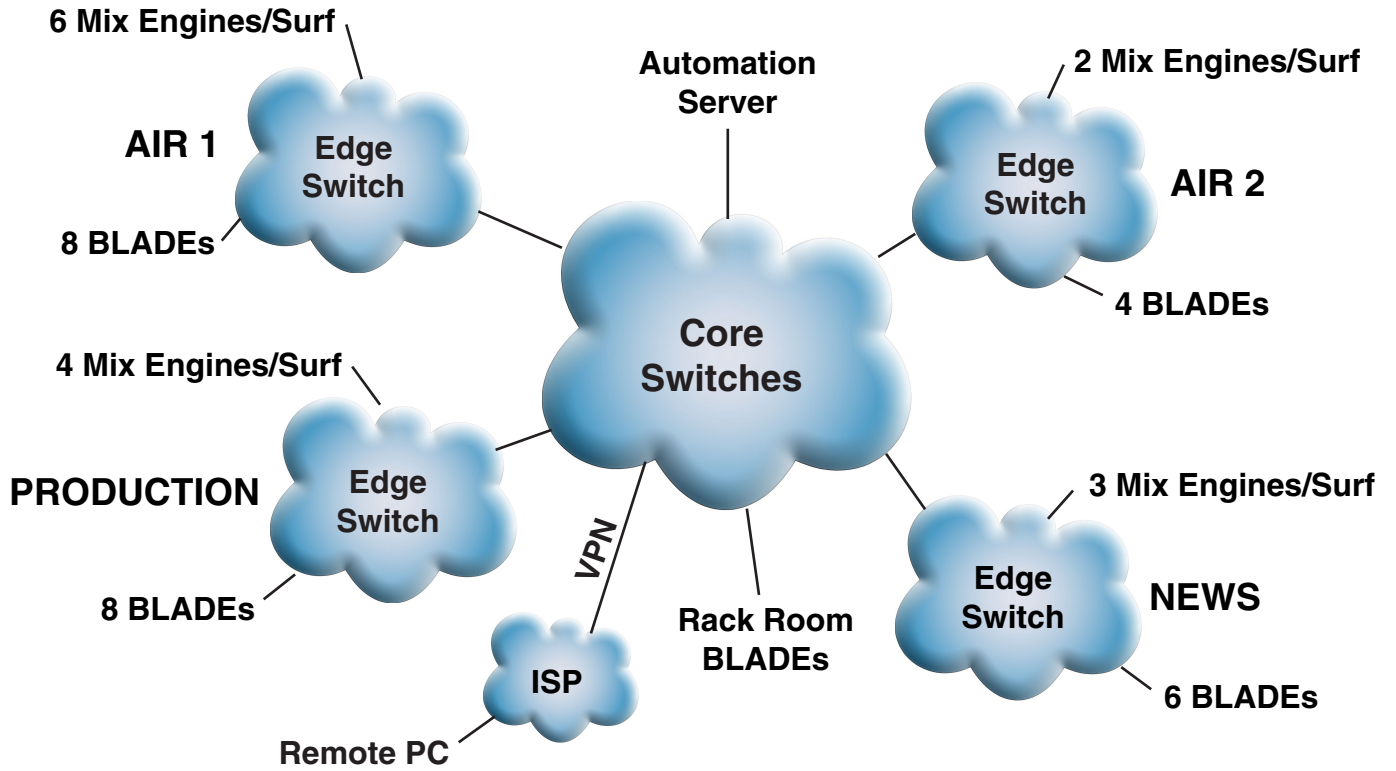

Network Troubleshooting

A variety of free software based tools can be effective in verifying, maintaining and troubleshooting network performance and configuration. Some rudimentary network testing may be done from the Command line in a DOS window using standard Internet Control Message Protocol (ICMP) commands built into Windows shell. A freeware or full blown network analysis program can be valuable when troubleshooting medium to large installations. Many managed switches include built in port traffic analysis using a web interface to the hardware.

Useful ICMP Commands

- **Ping** – Use this command to confirm that a device at a specific IP address is actually “talking” on the network. At the C:\> prompt in a command window type **ping xxx.xxx.xxx.xxx** where the x’s are the IP address of the device.
- **TraceRoute** – Use this command to find the path a PC takes to get from point a to b. At the C:\> prompt in a command window type **tracert xxx.xxx.xxx.xxx** where the x’s are the IP address of the destination you are tracing.
- **Ipconfig** – This is actually a console application in Windows that will display the network parameters configured for any network interface card installed on the PC.

Software Tools

- **WheatNet-IP GUI** – This Wheatstone application accesses configuration, status messaging, and error logging of all connected WheatNet-IP hardware.
- **WireShark** – This freeware (GNU) Network Protocol analyzer offers a comprehensive look at network traffic down to the packet payload level.
- **Telnet** – Used to open a Debug portal on a BLADE3 or surface. Use the built in Windows Telnet client or any third party client.
- **FTP** – Used to transfer files to and from surfaces. We recommend using a third party FTP client like Mozilla’s Filezilla.
- **SNMP** – Third party software can monitor the devices using SNMP. The MIBs created for the BLADE3 will allow users to monitor things like last boot time, Internal Temperature, Network Traffic, etc.

Simple Network Management Protocol (SNMP)

SNMP forms a part of the internet protocol suite defined by the Internet Engineering Task Force (IETF). Network management systems use SNMP to monitor network attached devices such as BLADE3s for conditions that may require action by the end user.

SNMP uses a manager/agent model that presents the information to the end user. A software component called the agent runs on the network device and sends the management information to the managing system. The managing system is the application that the end user needs to organize the information. The manager and the agent use a Management Information Base (MIB) and a small command set to exchange information.

The WheatNet-IP system provides information such as Uptime, Transmit and Receive packets, CPU utilization, and others. This information can be useful in locating potential issues and correcting the issues before they have an impact on the performance of the system.

Hardware Status Indicators

Check that your hardware meets the following parameters

- Switch LED's – No Link LED's: check wiring is CAT5e or better, check switch port configuration is GbE compliant, patch cables, full duplex, certify wiring.
- NIC Issues – Confirm NIC's are GigabitE, check IP config on PC.
- BLADE3 LED indicators – See Table Below.

STATUS LED	FUNCTION
Link	Shows network connectivity
Route Master	BLADE 3 has been voted route master for the system
Clock Master	BLADE 3 has been voted the master clock reference for the system
Error	Trouble with BLADE 3 configuration

Error Logs

In the WheatNet-IP system there are several places you can view logs to aid in troubleshooting. The PC GUI provides system wide logging to help pinpoint where a problem may exist. The PC GUI also has an “Alarms” section that displays any message that may require user attention such as silence detection notification.

PC GUI Log

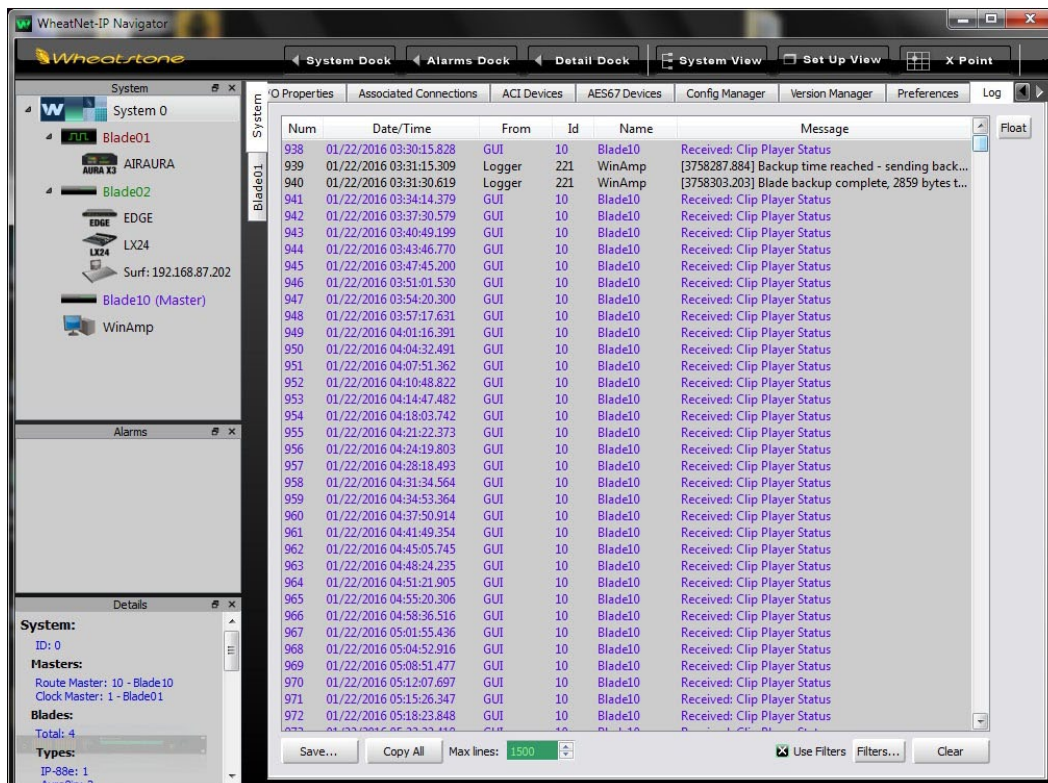

Alarms

The screenshot displays the WheatNet-IP Navigator interface. On the left, a tree view shows the system hierarchy: System 0, Blade01, AIRAURA, Blade02, EDGE, LX24, Surf: 192.168.87.202, Blade10 (Master), and WinAmp. Below this, an Alarms panel shows a 'Silence Detect - Failed Id: 1.0.0.5' alarm with details: Name: BL001D05, Location: Blade01, Width: Stereo. A 'Details' panel below shows 'Destination Signal' information: ID: 1.0.0.1 (00400001), Name: BL001D01, Location: Blade01, Width: Stereo, Card: 0 Circuits: 0, 1, Locked: No, Silence Detect: No. A 'Connected to Source' section shows ID: 2.1.0.0, Name: LX PGM. The main area is a grid with 'Sources' (AES 67 A, AA3 FM, JAY, AES 67 B, AA3 HD, PHIL, GUEST 1, GUEST 2, CALLER 1, CALLER 2, REMOTE 1, SEAHAWKS, MIXER 1, BL01UMX6, BL01A8A, BL01A8B, BL01A8C, BL01A8D, BL01A8E, BL01A8F, BL01A8G, BL01A8H, AA3 Pset, BL001D0L, EDJBIG1, EDJBIG2, EDJBIG3) and 'Destinations' (BL001D04, BL001D05, BL001D06, BL001D07, BL001D08, BL001D0B, BL01A8A, BL01A8B, BL01A8C, BL01A8D, BL01A8E, BL01A8F, BL01A8G, BL01A8H, BL01Hdpm, BL01UMX1*, BL01UMX2, BL01UMX3, BL01UMX4, BL01UMX5, BL01UMX6, BL01UMX7). A blue mouse cursor is over BL001D05, and a red dot is visible at the intersection of BL001D05 and AES 67 B.

Silence Detected on Output

WheatNet-IP Navigator GUI

Chapter Contents

Description	5-4
Using the Navigator GUI	5-5
An Important Point About WheatNet-IP Systems and System Master	5-18
Navigator GUI System Windows in Detail	5-19
Crosspoint Tab	5-19
Crosspoint Details Menu	5-21
Choose View	5-21
Fire Salvo.....	5-21
Destinations Sort By.....	5-21
Sources Sort By	5-22
Show	5-22
Destination Details Menu	5-22
Choose View	5-22
Fire Salvo.....	5-23
Destinations Sort By.....	5-23
Show	5-23
Rename Signal	5-24
Modify Signal.....	5-24
Lock Signal.....	5-26
Source Details Menu	5-27
Choose View	5-27
Sources Sort By	5-27
Show	5-27
Rename Signal	5-28
Modify Signal.....	5-28
Salvos/Macros Tab	5-30
Info Tab.....	5-32
Clock Master Info	5-32
Set Date and Time.....	5-33
Front Panel Passcode	5-34
Version Check	5-34
Blade Display Settings	5-35
LIO Properties Tab.....	5-36
Associated Connections Tab.....	5-38
Triggered Connections	5-38
Associated Connections	5-38
Config Manager Tab	5-39
Configuration Folder.....	5-39

Backup System Configuration	5-40
Current Crosspoint	5-40
Signal Info Text	5-40
Restore System Configuration	5-40
Version Manager Tab	5-41
Preferences Tab	5-42
General Section	5-42
Default View	5-42
Default Grid Labels	5-42
Default Sort Order	5-43
Check Boxes	5-43
Colors	5-44
Blade Preferences	5-46
Logger	5-47
Network	5-47
Log Tab	5-48
Locator Tab	5-49
Navigator GUI Devices Windows in Detail	5-50
Surfaces Tab	5-50
Peripheral Devices Tab	5-51
ACI Devices Tab	5-51
AES67 Devices Tab	5-52
Devices	5-52
Device Info	5-52
GBT Cards Tab	5-52
Navigator GUI BLADE3 Windows in Detail	5-53
Sources Tab	5-54
Source Signals	5-54
Free Resources	5-55
Add Button	5-56
Add Alias Button	5-56
Edit Button	5-57
Delete Button	5-58
Meters	5-58
Destinations Tab	5-60
Destination Signals	5-60
Free Resources	5-61
Add Button	5-62
Add Alias Button	5-63
Edit Button	5-63
Delete Button	5-63
Meters	5-64
Wire Info Tab	5-65
Visibilities Tab	5-66

LIO Info Tab	5-68
Silence Detect Tab	5-70
Destination Signals.....	5-71
Settings	5-71
Status	5-72
Logic.....	5-72
Utility Mixer Tab.....	5-73
Blade Info Tab	5-75
Config Manager Tab	5-77
A Word About Backup and Restore	5-78
Audio Player Tab	5-79
Status	5-79
Playlist	5-79
Capacity	5-79
Modify Playlist	5-80
Playback Control	5-80
More on System Pane	5-81

WheatNet-IP Navigator GUI

Description

The Navigator GUI is an optional software program designed to administer and manipulate WheatNet-IP networked audio systems. The use of this program is strictly optional, however we strongly recommend it because it makes many system functions much easier. Anyone who has tried to spell out a name via jog wheel and switch on a video game will appreciate how much easier it is to simply type it — especially if there are hundreds of names.

To use the Navigator GUI, it must first be installed on a PC running Windows. This program uses substantial computing power, especially in a large system, so we recommend using a computer with at least a 1.8GHz P4 processor and 1G memory. Insert the CD or USB flash Drive into the PC and run the installer program. Accept all of the suggested defaults unless you have experience with this program and have specific requirements. After the installer has completed its process, it will leave a shortcut to the Navigator GUI on your desktop. Double-click on the shortcut to launch the program. Before launching the program, you must make sure that the IP address of the PC is compatible with the WheatNet-IP system. It must have a fixed IP address on the .87 subnet.

When Navigator is first launched, the GUI opens a dialog box asking for a password. If the correct password is not entered, then system access is denied. The default is no password.

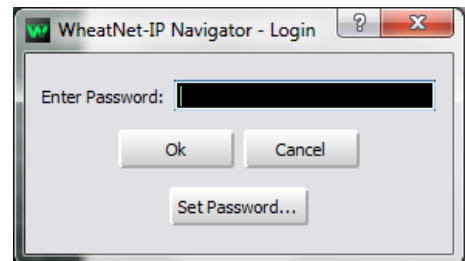

The first thing the program does after launching is to query the network the PC is connected to for any WheatNet-IP system present. This is an important thing to understand. Because WheatNet-IP networks, by their nature, are dynamic, the Navigator GUI can't know ahead of time what the network will be; it must inquire every time it is launched. This process takes anywhere from a few seconds for a small system up to a minute or so for a larger one. You can actually watch this process take place as the GUI discovers BLADE 3s and adds them to its list.

At the end of the discovery process you will see one of two things. First if the GUI could not find any BLADE 3s, it means that there is no WheatNet-IP system on its network. Usually this means that your PC is not actually plugged in to the network, or that your PC is running on a different subnet than the WheatNet-IP system. Remember, the default IP settings for BLADE 3s are all on the .87 subnet; this means your PC must have a fixed IP address of 192.168.87.xxx where xxx is any number not used by a BLADE 3 or other member of the network. Wheatstone recommends 192.168.87.20 if using the default IP scheme from the factory. Go to the TCP/IP properties under the Network Properties section on the Windows Control Panel and verify/change the settings. Additionally on some PC's you may also need to disable the Windows Firewall.

Secondly, if the PC has been addressed properly, in the left hand pane of the main GUI window, you will see a list of all the BLADE 3s the GUI was able to discover. In the center of the main window will be a password log-on window. Initially the GUI has no password assigned, so just click OK for now. Later on you can assign a password to prevent unauthorized modifications.

Using the Navigator GUI

The main window of the GUI is divided into several parts. Along the left hand edge are three smaller panes, one above the other. These three panes show the system view, the alarms view, and the details view. Their functions will be described shortly, but for now, just note that they are there, and that you can move and resize them as you would with many Windows programs.

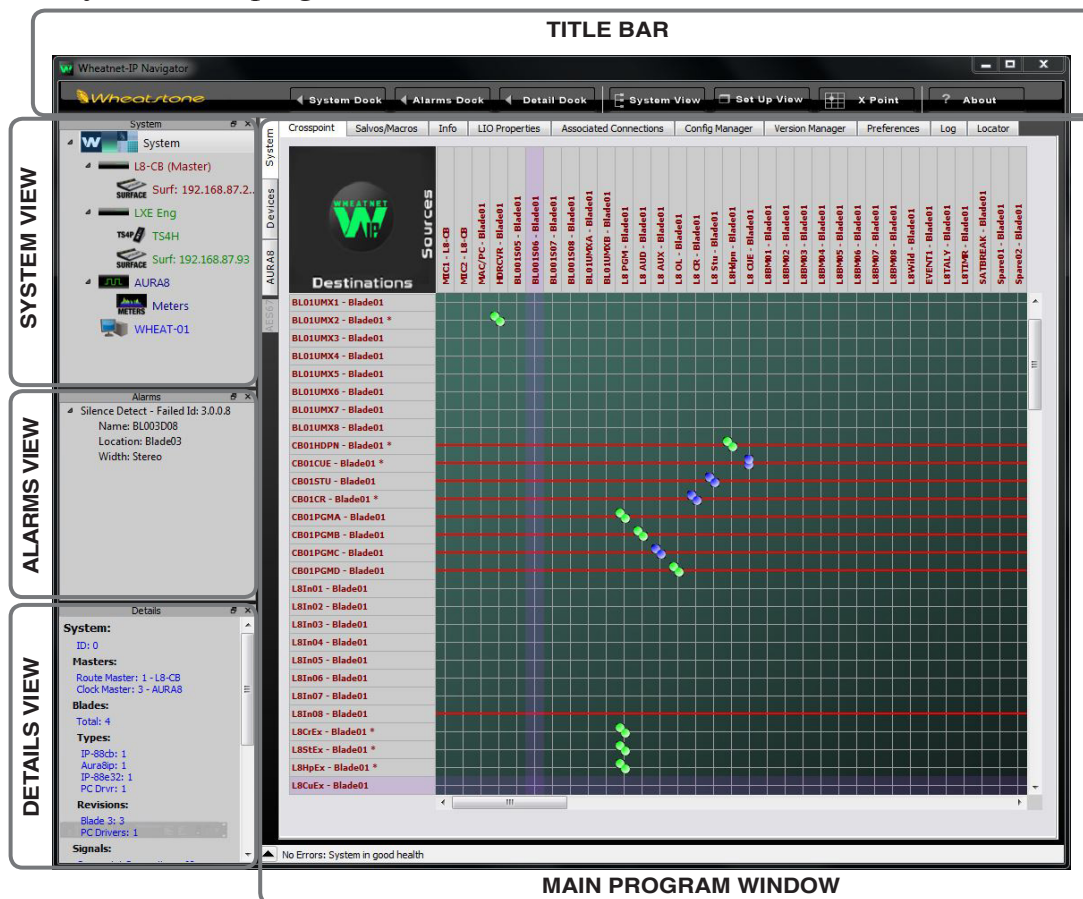

To the right of the three stacked panes is the main program window with two tabs, *System* and *Blades*, on the top left. Note that it has a number of tabs along its top, which when clicked on, will switch the main window to a number of different view dependant on the *System* or *Blades* part you are looking at. *System* or *Blades*. To familiarize yourself with the action of the various views, first click on the WheatNet-IP *System* icon in the System pane or *System* tab in main window. The main window will show information about the overall system, depending on which of the tabs in the main window have been selected.

Before we get into the tabs, take a moment to experiment with the system pane. If you've connected properly (remember, because WheatNet-IP networks are dynamic, each BLADE3 must be powered up and plugged into the LAN to be visible in the system pane) all of the BLADE3s in your system will show in the system pane.

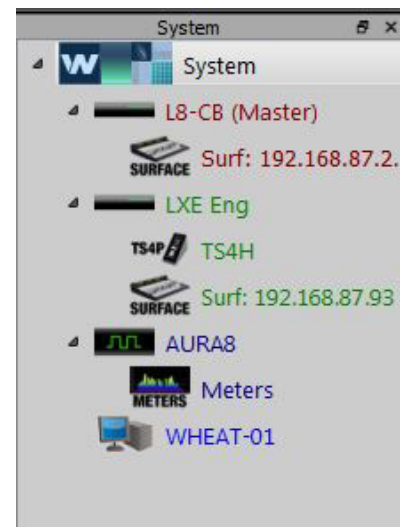

Each BLADE3 is shown with an icon and BLADE3 ID number. If it is the System Master, the designation (*Master*) will be shown beside the icon. If it is the Clock Master, a BLADE3 wave image will be overlaid on the icon (more on System Master and Clock Master later). If the BLADE3 is a mix engine BLADE3, then the icon will show a control surface icon attached to it, with the IP address of the corresponding control surface. If the BLADE3 is a streaming PC BLADE3, say one of your Automation Playback machines, the icon will change to represent a PC. Note that for a PC to become a part of a WheatNet-IP system and work with WheatNet-IP audio streams it must first have the WheatNet-IP PC driver software installed on it. Information about this is provided in the Appendix 5 of this manual.

If there are too many BLADE3s in your system to all show at once in the system pane, you can use a scroll bar on the right side of the pane to move through the list of BLADE3s.

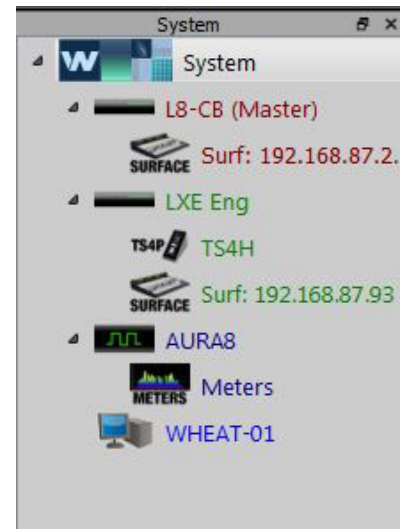

Now take a moment and temporarily unplug the network connection from one of your BLADE3s. You'll notice in the system pane window of the GUI, the icon of that BLADE3 has been overdrawn with a yellow question mark. This is to let you know that a BLADE3 was a member of your system but has become unavailable. If you ever see this during normal system operation, look for an unplugged network cable, or check to see if the power has been removed from a BLADE3 or a network switch. A short time after you plug the network cable back into the switch, the yellow question mark will disappear, indicating that the BLADE3 is available again.

To illustrate the dynamic nature of the WheatNet-IP system, quit the GUI by clicking in the close box at the upper right corner of the GUI window (not the system pane window, please). Unplug one of the BLADE3s and relaunch the Navigator GUI. Once the discovery process has been completed, if you check the system pane, the BLADE3 you unplugged will be missing from the list, as will all of its sources and destinations. Plug the BLADE3 back in, and after a short while, the BLADE3 and its sources and destinations will automatically get added back in. You have a dynamic network.

Now let's get back to the tabs.

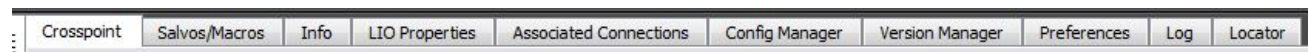

Crosspoint

The first tab is labeled *Crosspoint*. It shows a grid with system sources (their eight character names) running horizontally along the top, and the system destinations (again their eight character names) running vertically along the left side. The signal names are shown in different colors, matching the color of their BLADE 3 icon in the system pane. Connections between sources and destinations are shown by a connection icon at the grid intersection of the source and destination. The shape of the connection icon is an indication of the type of signal involved. To make a connection, click on an intersection. As the connection is made the appropriate icon will appear. To break a connection, click on the connection icon; the icon will disappear and the connection will be broken. If your system is larger than a couple of BLADE 3s, then the crosspoint grid will have scroll bars along the bottom and right sides, allowing you to scroll the grid view to see every part of your system window. There's much more you can do here but for now just understand the basics.

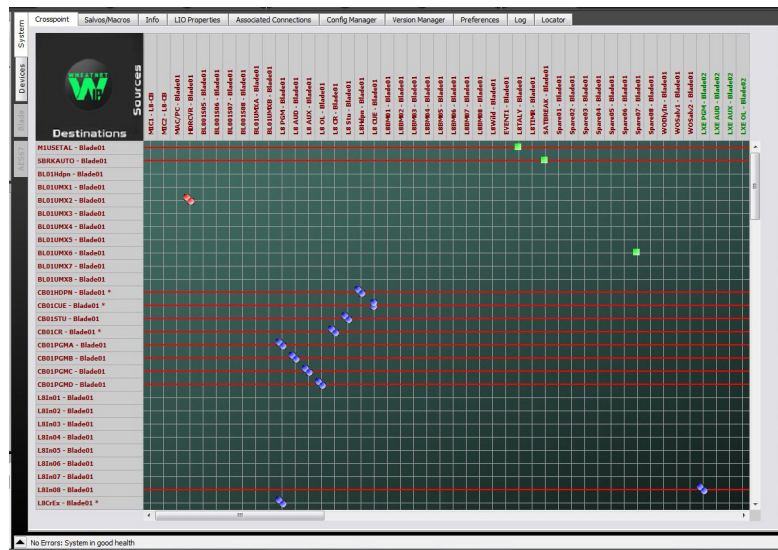

Salvos/Macros

The second tab is labeled *Salvos/Macros*. If you click on this tab, you will again see a crosspoint grid except that the words “Salvo Edit Screen” are shown in the background and some buttons have appeared above the grid. This is the screen used to create, edit, and execute Salvos (ganged simultaneous connections). More on this later.

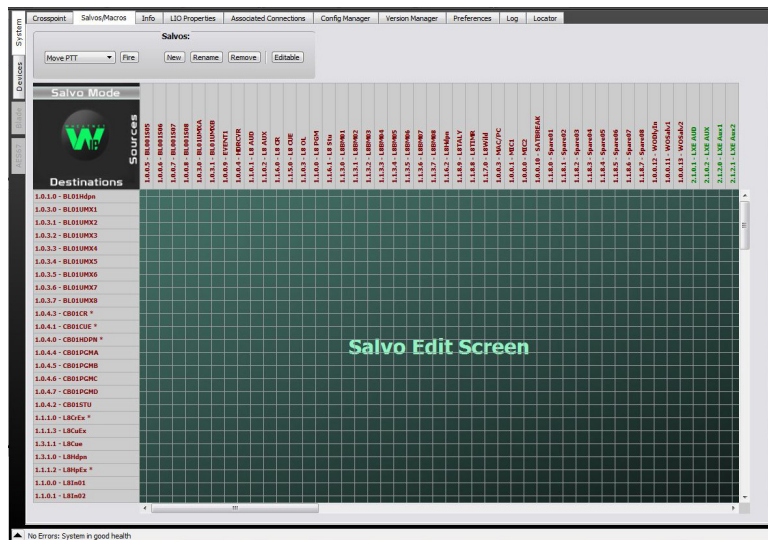

Info

The third tab is labeled *Info*. This is the screen where system clock rate, date and time, and passwords, Blade display are set.

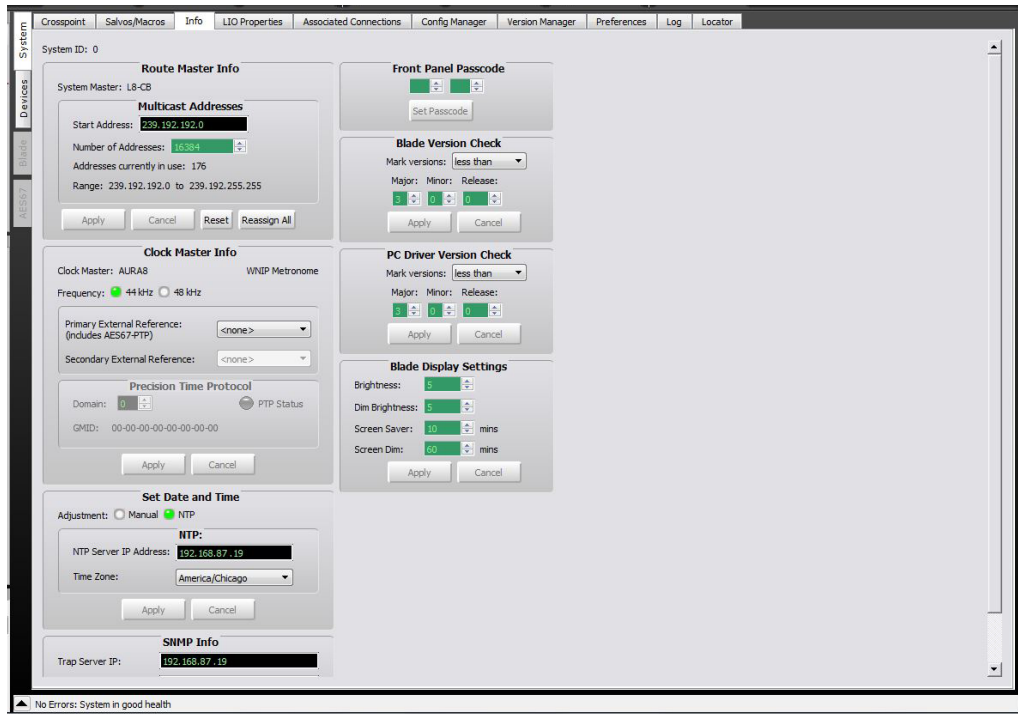

LIO Properties

The fourth tab is labeled *LIO Properties*. This screen is where you can define the states of various logic functions.

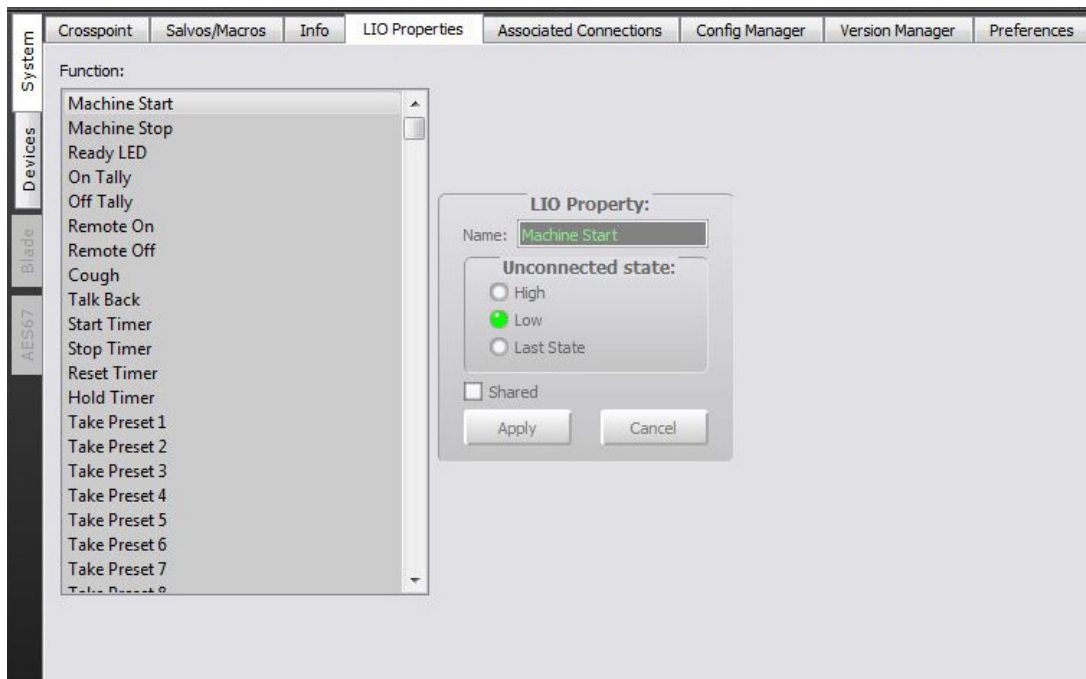

Associated Connections

The fifth tab is labeled *Associated Connections*. This screen is where you can define associated connections, to take the hassle out of changing connections between locations, studios or announcers. Simply define the link you need (ISDN, studio feed, remote, etc.) and BLADE3 can automatically set up a back link for it. Just trigger the connection and the back feed will follow – a helpful feature for remotes or for when you’re changing studios. Each BLADE3 comes with multiple associated connections limited only by memory.

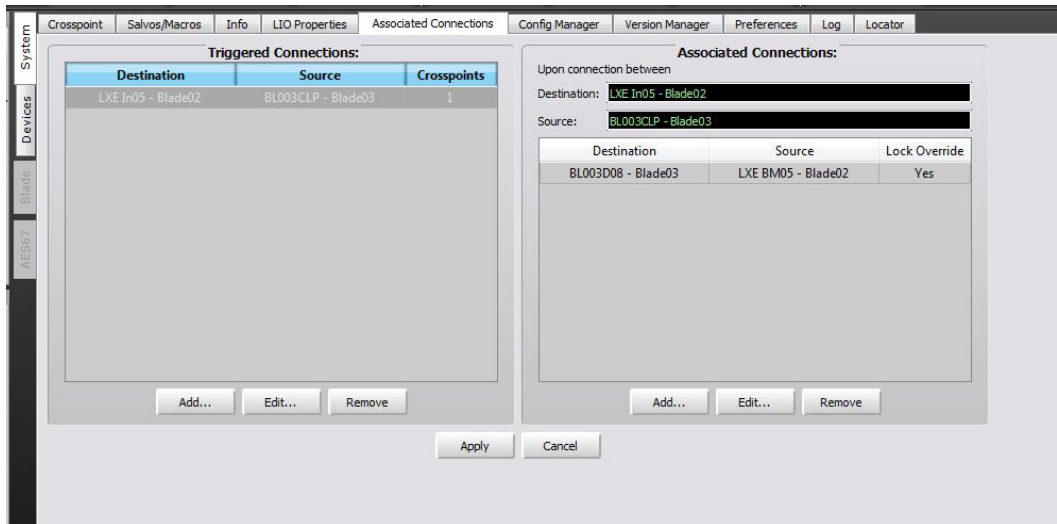

Config Manager

The sixth tab is labeled *Config Manager*. This screen is for archiving and restoring system information.

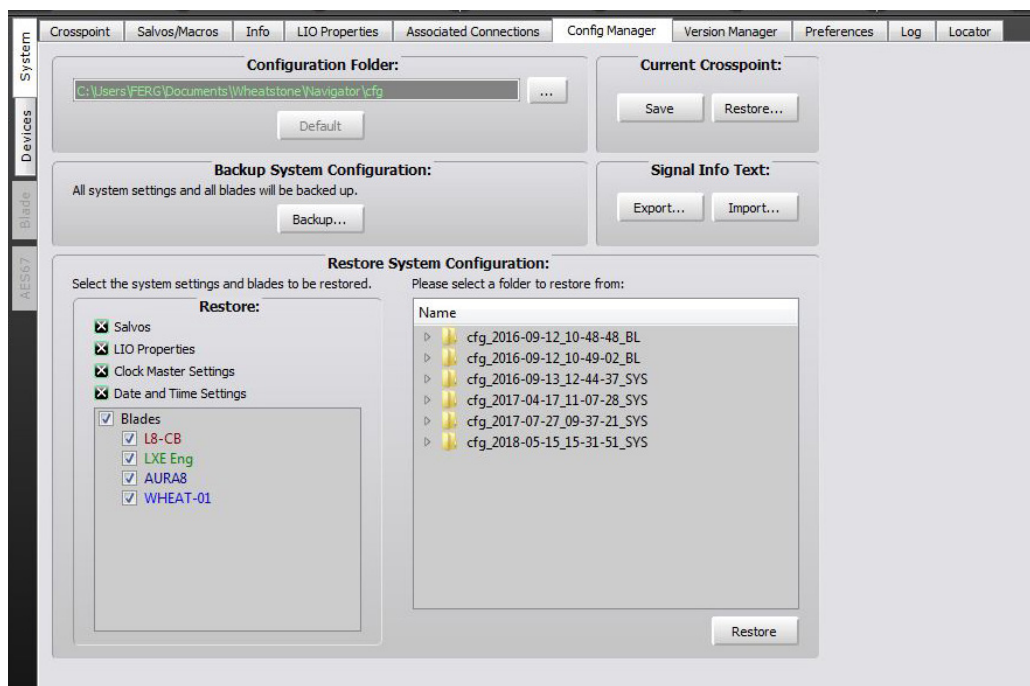

Version Manager

The seventh tab is labeled *Version Manager*. It opens an information window showing at once the current software and firmware versions of all BLADE 3s in your system. As the WheatNet-IP system evolves over time, there will no doubt be future updates that increase or improve functionality of the BLADE 3. This tab is a convenient way to keep track of the current versions on the BLADE 3. It also can be used to update the BLADE 3 with new versions.

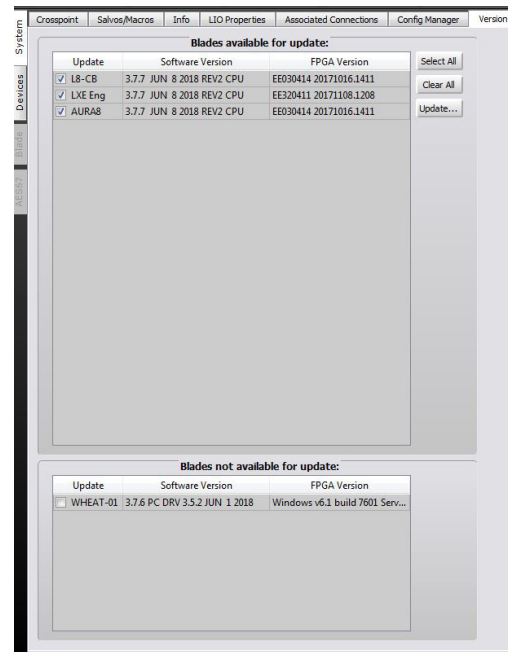

Preferences

The eighth tab is labeled *Preferences*. This screen is used to control the viewing and colors of various parts of the main Crosspoint window. You can specify colors for the dots and highlights, BLADE 3s and signal names, salvo indicators, etc.

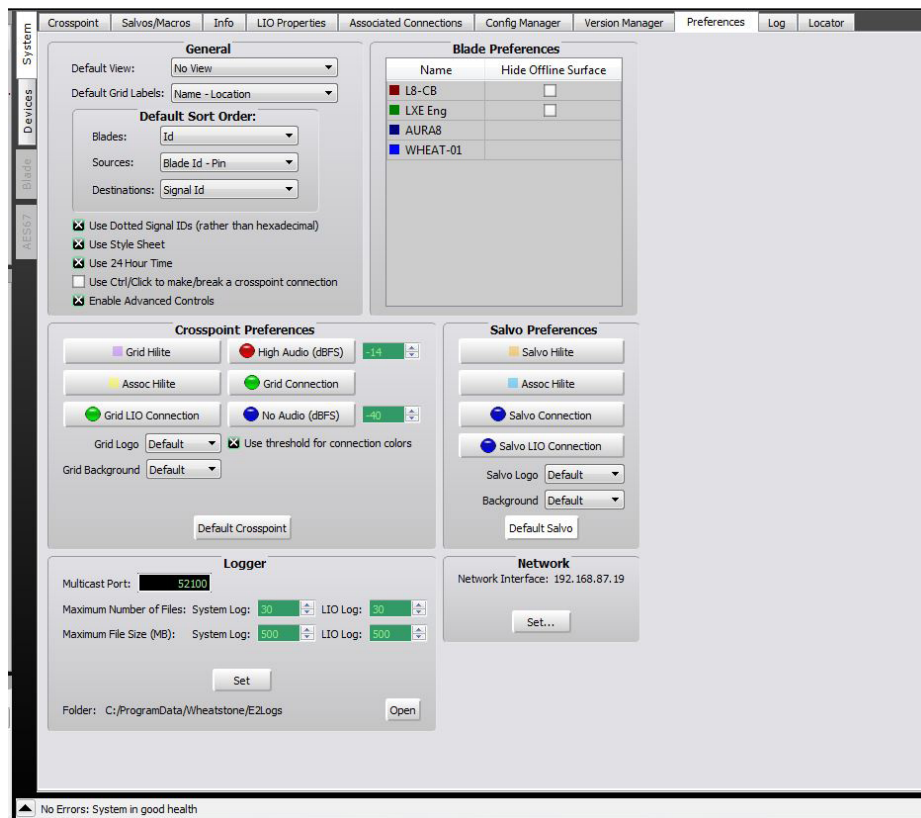

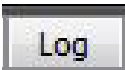

The ninth tab is labeled *Log*. This screen shows the logging of various system messages. More on this later.

Num	Date/Time	From	Id	Name	Message
95	07/05/2018 13:12:18.274	GUI	3	AURAB	Received: Input UMIx Duck
96	07/05/2018 13:12:18.274	GUI	3	AURAB	Received: Input UMIx Duck engine: 0 channel: 0 bus: 0
97	07/05/2018 13:12:18.274	GUI	3	AURAB	Received: Input UMIx Duck
98	07/05/2018 13:12:18.274	GUI	3	AURAB	Received: Input UMIx Duck
99	07/05/2018 13:12:18.274	GUI	3	AURAB	Received: Input UMIx Duck
100	07/05/2018 13:12:18.274	GUI	3	AURAB	Received: Input UMIx Duck
101	07/05/2018 13:12:18.274	GUI	3	AURAB	Received: Input UMIx Duck
102	07/05/2018 13:12:18.274	GUI	3	AURAB	Received: Input UMIx Duck
103	07/05/2018 13:12:18.274	GUI	3	AURAB	Received: Input UMIx Duck
104	07/05/2018 13:12:18.274	GUI	3	AURAB	Received: Input UMIx Duck
105	07/05/2018 13:12:18.274	GUI	3	AURAB	Received: Input UMIx Duck
106	07/05/2018 13:12:18.274	GUI	3	AURAB	Received: Input UMIx Duck
107	07/05/2018 13:12:18.274	GUI	3	AURAB	Received: Input UMIx Duck
108	07/05/2018 13:12:18.274	GUI	3	AURAB	Received: Input UMIx Duck
109	07/05/2018 13:12:18.274	GUI	3	AURAB	Received: Input UMIx Duck
110	07/05/2018 13:12:18.274	GUI	3	AURAB	Received: Input UMIx Duck
111	07/05/2018 13:12:18.274	GUI	3	AURAB	Received: Input UMIx Duck
112	07/05/2018 13:12:18.274	GUI	3	AURAB	Received: Output UMIx
113	07/05/2018 13:12:18.274	GUI	3	AURAB	Received: Setup UMIx
114	07/05/2018 13:12:18.274	GUI	3	AURAB	Received: Setup UMIx 1.0 -1200 Utility Mixer 2
115	07/05/2018 13:12:18.274	GUI	3	AURAB	Received: UMIx Lio Config
116	07/05/2018 13:12:18.274	GUI	3	AURAB	Received: Peripheral Info
117	07/05/2018 13:12:18.274	GUI	3	AURAB	Received: LIO Wires
118	07/05/2018 13:12:18.274	GUI	3	AURAB	Received: LioWires: begin=true entries: 151
119	07/05/2018 13:12:18.274	GUI	3	AURAB	Received: ACT Connection Info
120	07/05/2018 13:12:18.344	GUI	3	AURAB	Received: AP Input Names
121	07/05/2018 13:12:18.344	GUI	3	AURAB	Received: ProcessorInputList: begin=true entries: 8
122	07/05/2018 13:12:18.364	GUI	3	AURAB	Received: AP Preset Names
123	07/05/2018 13:12:18.364	GUI	3	AURAB	Received: ProcessorPresetList: begin=true entries: 80
124	07/05/2018 13:12:18.364	GUI	3	AURAB	Received: Proxy Server Info
125	07/05/2018 13:12:18.834	GUI	19	WHEAT-01	Connected
126	07/05/2018 13:12:18.834	GUI	19	WHEAT-01	Received: Version
127	07/05/2018 13:12:18.834	GUI	19	WHEAT-01	Received: Net Info
128	07/05/2018 13:12:18.834	GUI	19	WHEAT-01	Received: Src Signal List
129	07/05/2018 13:12:18.834	GUI	19	WHEAT-01	Received: Src Signal List Message 24 Signals
130	07/05/2018 13:12:18.844	GUI	19	WHEAT-01	Received: Dst Signal List
131	07/05/2018 13:12:18.844	GUI	19	WHEAT-01	Received: Dst Signal List Message 26 Signals
132	07/05/2018 13:12:18.864	GUI	19	WHEAT-01	Received: GPIO Pin Config
133	07/05/2018 13:12:18.864	GUI	19	WHEAT-01	Received: LIO Wires
134	07/05/2018 13:12:18.864	GUI	19	WHEAT-01	Received: LioWires: begin=true entries: 128
135	07/05/2018 13:12:19.424	General	1	L8-CB	Detect master state change for blade 1. Master state is: 1
136	07/05/2018 13:12:19.424	General	1	L8-CB	Setting as system master: id: 1



The tenth and final tab across the top is the *Locator* tab. The *Locator* tab allows the user to ping the network to get a list of devices that are attached to the network. Additionally, filters can be added to pair down the list by device type, in addition to the ability to sort any of the fields in the results.

Vendor	Category	Product	Component	Name	Location	Host Data	IP Address	Subnet Mask	Default Gateway	MAC Addr	Refresh	
Wheatstone	WNIP Blade	PC Dvr	Play	WHEAT-01			192.168.87.19	255.255.255.0	0.0.0.0	D8:EB:97:68:E84		
Wheatstone	WNIP Surface	LXE	Surface Host	WHEAT-LXE	LAB		192.168.87.93	255.255.255.0	192.168.87.1	00:30:18:C6:E84		
Wheatstone	WNIP Blade	IP-88e32	Play	LXE Eng			192.168.87.102	255.255.255.0	192.168.87.1	80:E4:DA:00:1E		
Wheatstone	WNIP Blade	Aura8ip	Play	AURAB			192.168.87.103	255.255.255.0	192.168.87.1	80:E4:DA:00:17		
Wheatstone	WNIP Blade	IP-88cb	Play	L8-CB			192.168.87.101	255.255.255.0	192.168.87.1	80:E4:DA:00:11		
Wheatstone	WNIP Blade	Aura8ip	Vorsis Aura8ip	AURAB			192.168.87.103	255.255.255.0	192.168.87.1	80:E4:DA:00:17		
Wheatstone	WNIP Controller	TS4P	TS4P				192.168.87.220	255.255.255.0	192.168.87.1	80:E4:DA:00:15		
Wheatstone	WNIP Surface	LXE	Module Panel	WHEAT-LXE	Panel 1		192.168.87.93	169.254.188.32	255.255.0.0	0.0.0.0	80:E4:DA:00:20	
Wheatstone	WNIP Surface	LXE	Module Panel	WHEAT-LXE	Panel 2		192.168.87.93	169.254.196.32	255.255.0.0	0.0.0.0	80:E4:DA:00:20	



The Side Tabs are arranged to show System and its tabs covered above, Devices, Last Selected Blade, and AES67 Devices.

With the Devices Tab Select the Top Row Tabs change to Display the Device Tabs.

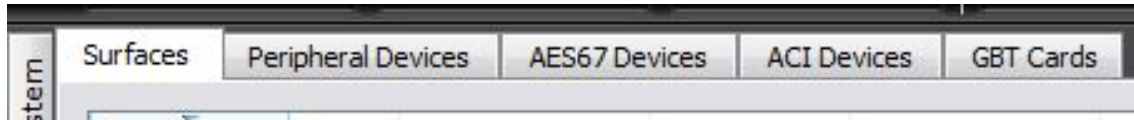

Surfaces The Surfaces Tab when selected displays the currently connected WNIP Surfaces in the system. Information such as software version, number of faders and spare buttons are also displayed.

Launch	Status	Surface	Type	IP Address	Host Blade	Id	SW Version	HW Version	Num Spares	Num Faders	Error Message
X	●	L8 Mixer	L8 Mixer	192.168.87.201	L8-CB	1	1.4.14	1.4.14	8	8	
X	●	LXE Mixer	LXE Mixer	192.168.87.93	LXE Eng	1	1.23	1.23	14	32	

Host Blade	Type	Id	IP Address
Blades with unconnected surfaces:			

▲ No Errors: System in good health

Peripheral Devices The next tab is the Peripheral Devices Tab. This tab allows for adding Razor Devices and Surfaces where internal cue and headphone mixes need to be added in order to create the Multicast Audio Streams.

Launch	Status	Device	IP Address	Port	Host Blade	Id	Vendor	Product	
Launch	●	L8	192.168.87.201	60021	L8-CB	1	Wheatstone	L8	Add...
Launch	●	TS4H	192.168.87.220	60021	LXE Eng	1	Wheatstone	TS4P	Edit...
X	●	Meters	192.168.87.19	60021	AURA8	1	Wheatstone	MeterMonitor	Remove

AES67 Devices

This screen is where you can add or remove AES67-compliant devices and signals into the WheatNet-IP Intelligent Network. The BLADE 3s support AES67 compliant devices using an IEEE1588 PTP grandmaster clock for synchronizing to and ingesting/streaming AES67 compliant packets. Refer to the “WheatNet-IP and AES 67” Appendix 11 for more information.

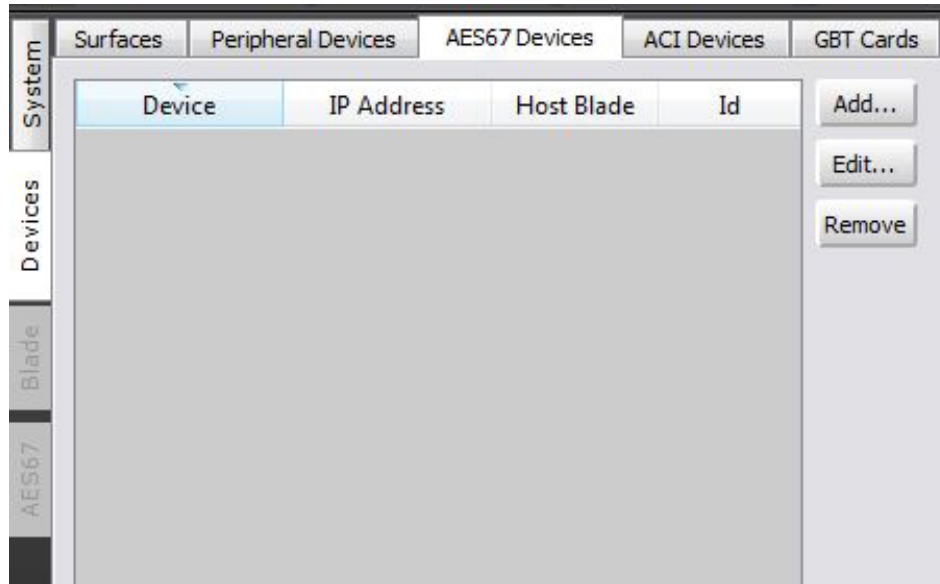

ACI Devices

This is a convenient place that lists all of the various ACI devices that have been defined for your system so you can see them all (and their IP Addresses, BLADE 3 IDs, etc.) at a glance.

Launch	Status	Blade	Id	IP Address	Subscriptions	Vendor	Product	Name	MAC Address	SW Version	FW Version	SVM Version	Text
0	X	1	0	192.168.87.93	10								IP Screen Engine @ Ixe
1	Launch	1	1	192.168.87.70	11	Wheatstone	GP-16P	gp1	40-D8:55:1D:7D:C0	3.6.5	0A.05	2.7.0	IP Screen Engine @ Ixe
2	X	2	0	192.168.87.93	3								IP Screen Engine @ Ixe
3	Launch	2	1	192.168.87.220	2	Wheatstone	TS4P	TS4P	80-E4:DA:00:15:EA	1.4.5	0A.15		
4	X	3	0	192.168.87.19	2								MeterApp

GBT Cards

This tab displays information about connected GBT cards connected to the WNIP System. GBT cards are special cards placed in Gibraltar Cages to interface it to a BLADE 3 System.

Status	Blade	Location	IP Address	MAC Address	HW Version	IGMP Query Rate	State

Experiment with clicking on the various tabs until you become familiar with what they contain.

Now comes the good part. Over on the System pane, click on a BLADE icon, or click on *Blades* tab in the main window. The main window changes from a System view to a Blades view, and there are nine new tabs showing information about the particular BLADE 3 you clicked on. The tabs are *Sources*, *Destinations*, *Visibilities*, *LIO Info*, *Silence Detect*, *Utility Mixer*, *Blade Info*, *Config Manager*, and *Audio Player*.



They provide lots of functions and information about the particular BLADE 3. Again, more on this later.

Of course, if you now click on a different BLADE 3 in the system pane, the main window will show you nine more tabs representing the BLADE 3 you just clicked on.

In this manner you can look at/work on each individual BLADE 3 in the system. Now go back and click on the system icon in the system pane and select the System Crosspoint tab. Click on one of the destination signal names along the left side of the grid and notice the information that appears in the “Details” pane. Essentially everything you would like to know about that signal appears in the Details pane: what its name and ID are, what BLADE 3 it’s in, what mode it is, which jacks it uses, what source is crosspoint connected to it, and more. Each time you click on a source or destination name, its information is reflected in this Details pane.

Finally note the Alarms pane normally located just below the system pane. The Alarms pane is a text area that shows a message whenever an alarm function, such as Silence Detection on a particular output, happens.

The System pane, Alarms pane, and Details pane are all scrollable and resizeable in typical Windows fashion. You can also drag and relocate them

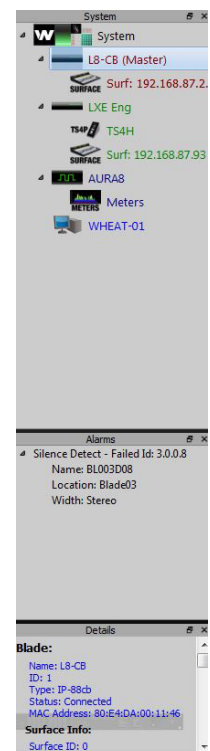

on the screen, or dock them back to their default locations using the dock buttons along the top of the screen.



In addition to the System, Alarms, and Detail dock buttons, the top of the screen contains buttons for System View, Set Up View, and XPoint.



These buttons activate navigation shortcuts that will take you to some commonly used areas of the Navigator GUI program.

In the WheatNet-IP system, the mechanism for showing a subset of all of the system audio signals is called filtering. You can specify certain search criteria or functions, and the software will restrict the crosspoint grid to show only those signals that fit the criteria. In a large system with hundreds or even thousands of signals, filtering is a way to reduce the amount of scrolling you need to do while navigating on the crosspoint grid. Some common filters might be “show only the signals in BLADE 3s 2 and 14,” or “show me only my mono signals,” or “show me only logic signals.” As you might expect, you can combine the criteria to create a complex search that significantly reduces the number of signals that meet it.



Open the System View window by clicking on the *System View* button at the top of the screen.

This screen contains a table with your system information. You can customize the table with the buttons located in the Show area on the left bottom corner of the screen to show or hide the *Network Info*, *Version Info*, *Signal Info*, and *Device Info*.

Status	Id	Name	Type	IP Address	Subnet	Gateway	MAC Address	Route Master	Clock Master	Slave Mode	Active CPU	Spare CPU	SW Version
●	1	L8-CB	IP-88cb	192.168.87.101	255.255.255.0	192.168.87.1	80:E4:DA:00:11:46	90	50 - Default	Off			3.7.7 JUN 8 2018 REV2 C
●	2	LXE Eng	IP-88e32	192.168.87.102	255.255.255.0	192.168.87.1	80:E4:DA:00:1E:55	80 - Default	50 - Default	Off			3.7.7 JUN 8 2018 REV2 C
●	3	AURAB	Aura8ip	192.168.87.103	255.255.255.0	192.168.87.1	80:E4:DA:00:17:51	80 - Default	90	Off			3.7.7 JUN 8 2018 REV2 C
●	19	WHEAT-01	PC Dvr	192.168.87.19	255.255.255.0	0.0.0.0	D8:EB:97:68:EB:9E	N/A	N/A	N/A			3.7.6 PC DRV 3.5.2 JUN 1

Blades Sources Destinations Source Streams Destination Streams Latency Resources Devices

Show

- Network Info
- Version Info
- Signal Info
- Device Info
- Proxy Info

Save



Open the Set Up Crosspoint Views window by clicking on the *Set Up View* button at the top of the screen.

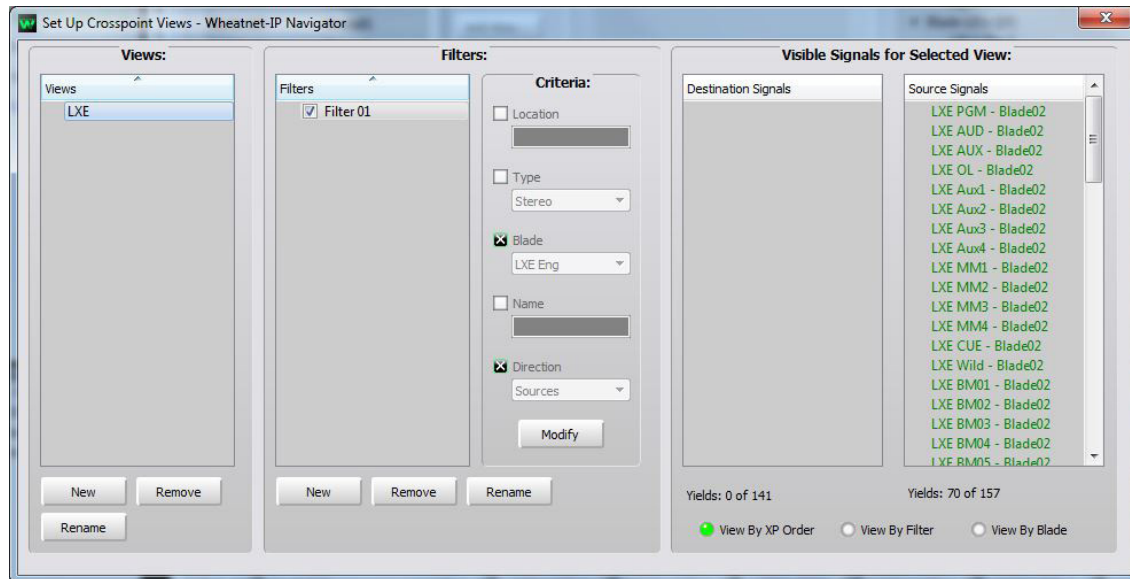

In the window you will notice a list of the currently defined filters, along with some buttons used to create, rename, or delete them. If the list appears empty, then no filters have yet been defined. Click on the *New* button and a new filter having a default name is added to the list. Click the *Rename* button to open a dialog box that allows you to rename the filter. Type a name that will help you recognize the filter later such as “BLADE 3 1” or “Morning Show,” click *OK*, and the window will change to show you the criteria you can specify for your filter. As you click on various check boxes to specify criteria, notice how the source and destination signal lists change to reflect the filter’s effect once you’ve also created a view (see below). Obviously, if you make your filter too exclusive, the signal count will dwindle to zero and the filter will therefore be useless. After all, what good is a filter that removes all of the signals from view, leaving nothing but a blank screen? Don’t hesitate to experiment with defining a few filters and seeing how they work. You can always delete them later.

Once you have created a filter, you need to assign it to a view before you can use it. A “View” is simply a collection of one or more filters, and is useful for combining filters for a more complex set of criteria.

Initially, as in filters, no views will show in the list until you have created them. Click on *New* to create a view; you can use the *Rename* button to give it a special name.

Once you have defined one or more views, click on the view name to highlight it. Then, in the Filters list, click on the check boxes to enable the desired filter function(s). Enabling the view by right clicking on the WheatNet-IP logo on the crosspoint grid will give you a new crosspoint grid view with the signals reduced to only those that meet the criteria.

One final note about filters: If you are having trouble locating a signal on the crosspoint grid, make sure you haven’t inadvertently enabled a view that excludes it. Right click on the WheatNet-IP logo and *Choose View / No View* to be sure.

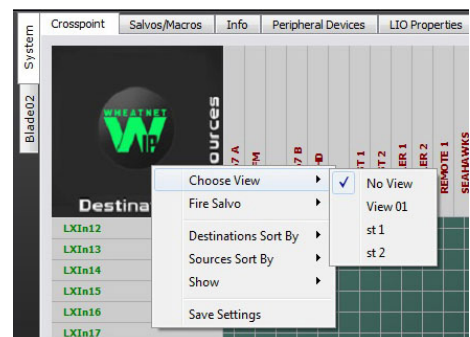



Clicking on this button opens a crosspoint grid window on a floating palette. This can be a very handy function when you are working on a part of the system GUI and need a quick look at the grid to check on some signal or connection information. You could close down whatever window you are working on and go to the “System Crosspoint” tab, but that might mean leaving your work unfinished. Instead, try clicking on the “XPoint” button and opening this floating grid window. You can position it where you like on the screen and use it for reference as you continue your work.



Predictably, this button opens a window displaying the version information for the WheatNet-IP Navigator GUI program.

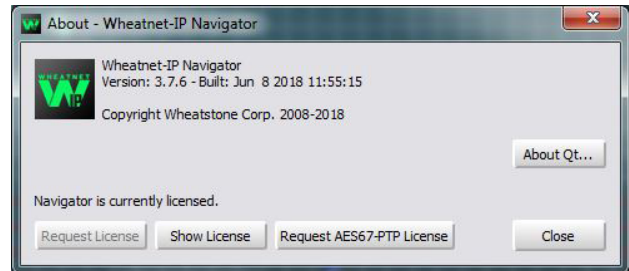

Now you have learned the basics of navigating around the WheatNet-IP Navigator GUI. It makes no difference if your WheatNet-IP system has two BLADE 3s in it or a hundred, they are all treated the same way.

An Important Point About WheatNet-IP Systems - The System Master

Because the WheatNet-IP system is dynamic, there needs to be some mechanism to arbitrate and maintain the specifics of the system configuration from moment to moment. “Somebody has to be in charge!” In the WheatNet-IP system, we don’t rely on a PC for this role; the entire system is fully functional without any PCs. Since all BLADE 3s are electrically identical (except for their specific audio I/O ports) the system has been architected with a distributed intelligence. Each and every BLADE 3 has enough on-board intelligence to control the whole system by itself. During initial set up, one of the BLADE 3s in the system is automatically selected to be System Master. It is this System Master BLADE 3 that gathers all of the information from the BLADE 3s, control surfaces, and PCs that belong to the system. The Master BLADE 3 then redistributes all of this information back to every BLADE 3. The Master BLADE 3 and all of the others keep this information in flash memory so it is not lost when the power is turned off. What this means is that every BLADE 3 is fully capable of running the entire system at any moment. In fact, if the Master BLADE 3 is lost for any reason, a new BLADE 3 will be elected as Master and seamlessly take up running the system. The beauty of this architecture is the depth of backup and redundancy automatically provided. Essentially there are as many backup hosts in the system as you have BLADE 3s; you can never lose your system because a host controller went down. The need for archiving is also greatly reduced, because there is a system copy residing in every BLADE 3. It’s like having a RAID array of hosts. If you look carefully at the list of BLADE 3s in the System Pane, you will see one of them designated as the current System Master. There is also a front panel LED indicator that lights to show that the BLADE 3 is functioning as the Route Master.

Similarly, the system will also have a Clock Master, responsible for synchronizing timing throughout the system. If a Clock Master has been designated via the system Info tab (see later in this chapter) by assigning a Primary External Reference, then that BLADE 3 will be indicated in the System Pane by the “wave” icon – see Blade01 in the example shown. If, however, no such assignment is made, the system will self-designate a Clock Master and flag it as such in the System Pane. Once again, a front panel LED lights on the designated BLADE 3.

Note that in a single BLADE 3 system the one BLADE 3 will serve as both the System Master and the Clock Master.

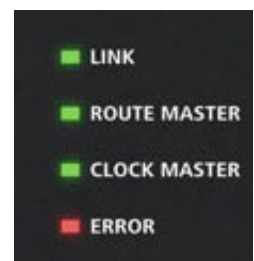
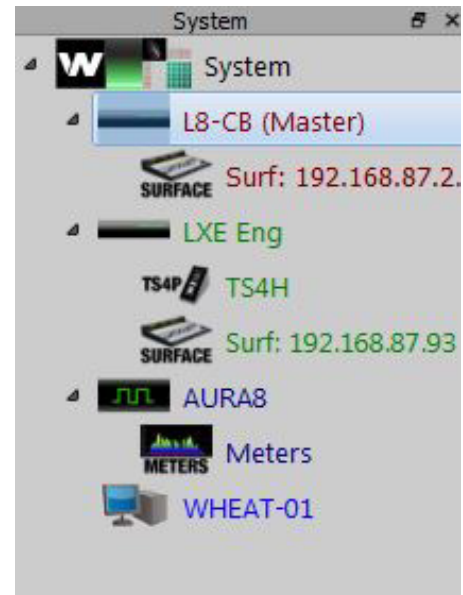

Navigator GUI System Windows in Detail

Crosspoint Tab

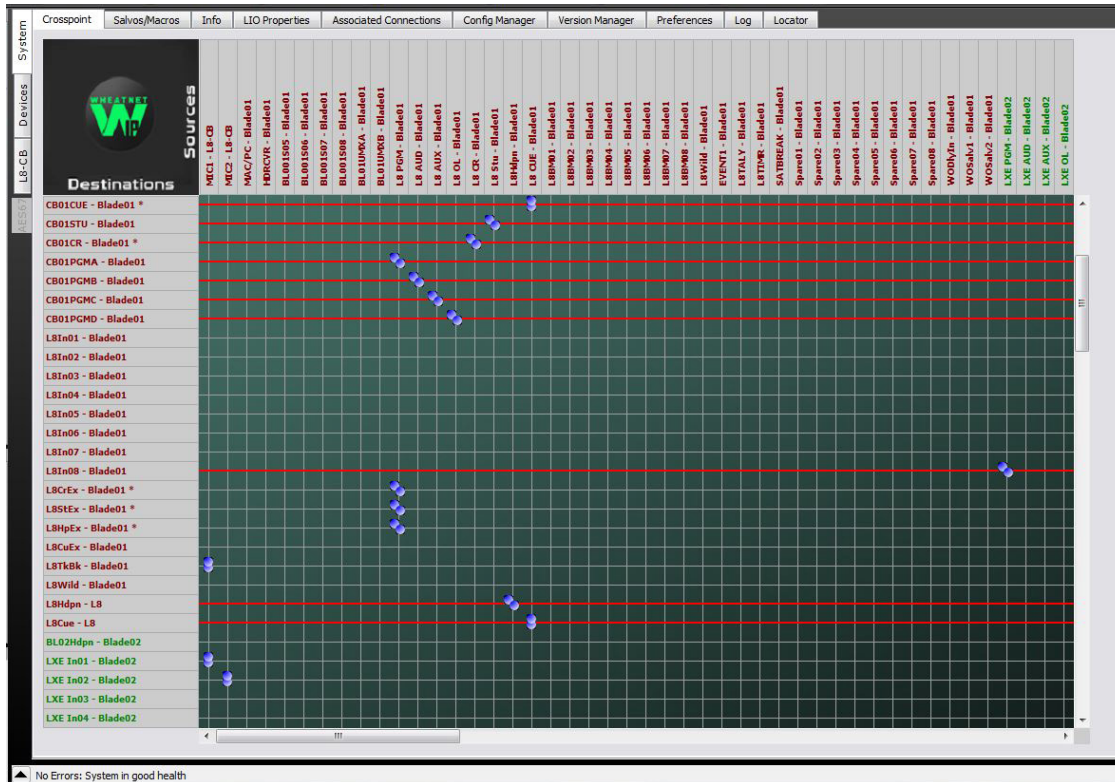

This window is the main crosspoint window for the GUI. It is used to make/break/view crosspoint connections. In a LAN based audio network, just what is a crosspoint connection? After all, there is no audio router or patch bay to make audio connections. Simply put, a crosspoint connection represents a message that a particular destination (i.e. network address) wants to subscribe to the multicast packets representing a particular audio stream. The Ethernet switch obliges by forwarding those packets along to the subscribing device. In the Navigator GUI, this is shown by a connection icon at the grid intersection of the source and destination. of the source (multicast stream) and destination (subscribing device).

The shape of the connection icon is an indication of the type of signal involved. Signal types are mono audio, stereo audio, logic only, or logic and audio combined. The connection icons you will encounter are:

- – both the source and destination signals are logic only
- – both source and destination signals are mono audio
- ∞ – the source is mono audio and the destination is stereo audio
- ∞ – the source is stereo audio and the destination is mono audio
- ∞ – both source and destination signals are stereo audio
- – any source or destination signal is surround audio
- – indicates BLADE's communication issue; this icon always yellow.

Note that any audio signals may have associated logic signals riding on them, but this will not affect the shape of the connection icon.

To make a connection, click on an intersection. As the connection is made the appropriate icon will appear. To break a connection, click on the connection icon; the icon will disappear and the connection will be broken.

In BLADE 3 the connection icons are animated, with the color of the icon changing in accordance with signal level. Parameters related to connection icon colors and color changes are available on the Preference tab.

By default settings the blue color means no audio (-40dBFS), the green color means normal level audio (a level between the no audio and high audio setting), and red color indicates high level audio (-14dBFS).

Right-clicking on an audio connection icon and choosing *Monitor...* brings up a display where you can see meters showing the source and destination levels. A button and volume slider on this display will allow you to monitor the audio on the Navigator computer.

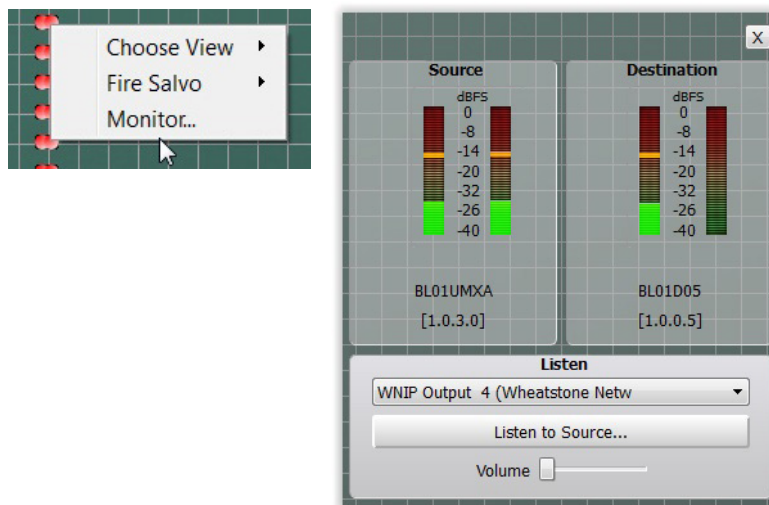

You can configure the colors you want (except for the large gold dot) for the various route representations on the System *Preference* tab. This is also where you configure the threshold settings for the desired no audio and high audio levels.

A large gold dot indicates that Navigator is not receiving the confirmation back from the BLADE3 that the requested connection has been established. This usually indicates a connection problem of some sort.

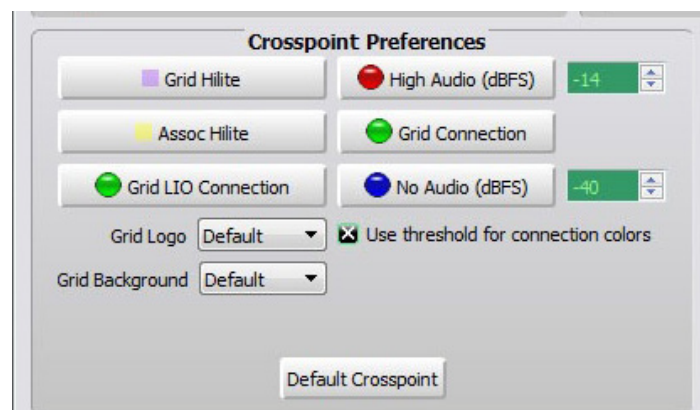

In the most basic view, the Crosspoint window shows all of the system sources across the top and all of the system destinations vertically on the left. The default view has these signals shown first in numerical order of the BLADE3s, and alphabetically by signal name within the BLADE3. Furthermore, each BLADE3 has a color, and the BLADE3's signals are shown printed in matching color. This is meant to help identify which signals go with which BLADE3.

CROSSPOINT DETAILS MENU

There are refinements to the basic view that come in very handy. If you right click on the WheatNet-IP logo of the system crosspoint window, a popup window with four sub-menus will appear.

Choose View

Various filters can be defined to restrict the crosspoint view of the system. This is useful when you have a large system with hundreds of signals and want to work on a small section of it. The filter manager tool of the GUI (see the Set Up View button discussion) allows you to define filters based on BLADE3 ID, signal type (mono, stereo, logic only), location, sources, or destinations, and assemble them into Views. The Choose View menu allows you to specify any of the views you have defined, and the crosspoint grid will immediately shrink, removing those signals not part of your selected view.

Hint: If you know you have a signal in your system but it is not appearing in the crosspoint grid, right-click on the WheatNet-IP logo and select Choose View / No View. Chances are your signal will now appear in the grid – your filter setting was excluding it.

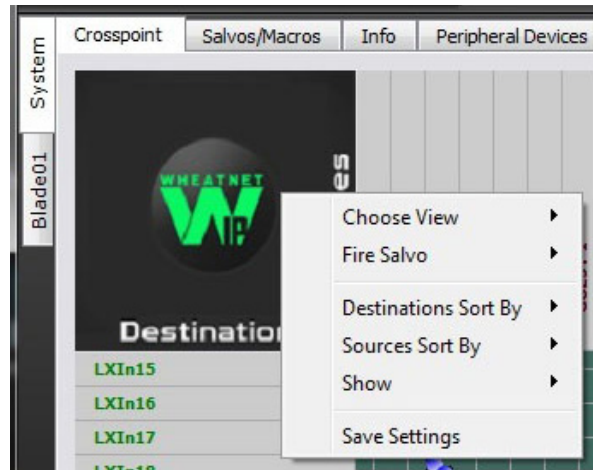

Fire Salvo

Fire a Salvo is simply a matter of scrolling through the list to highlight the desired Salvo. You will see in Crosspoint window that your connection changes actually happened.

Destinations Sort By

This menu allows you to change the order in the crosspoint grid for the destination signals. The choices are:

BLADE Id - Name – This is the default. The destinations show in order of BLADE3 ID, then alphabetically by name.

BLADE Id - Pin – The destinations show in order of BLADE3 ID first, then connector number.

BLADE Id - Location – The destinations show in order of BLADE3 ID, then alphabetically by location name.

Name - BLADE Id – The destinations show alphabetically by name first, then by BLADE3 ID Useful for when you use a name like “CD 1” over and over.

Name - Location – The destinations show alphabetically by name first, then by location name.

Location - BLADE Id – The destinations show alphabetically by location name, then by BLADE3 ID.

Signal Id – The destinations show in order of their system assigned signal ID.

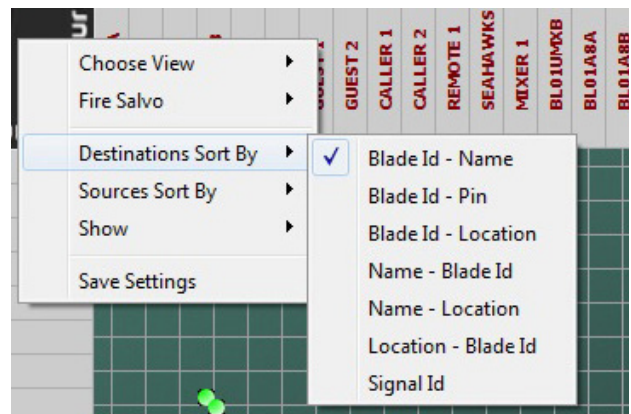

Sources Sort By

This menu allows you to change the order in the crosspoint grid for the source signals. The choices are:

BLADE Id - Name – This is the default. The sources show in order of BLADE 3 ID, then alphabetically by name.

BLADE Id - Pin – The sources show in order of BLADE 3 ID first, then connector number.

BLADE Id - Location – The sources show in order of BLADE 3 ID, then alphabetically by location name.

Name - BLADE Id – The sources show alphabetically by name first, then by BLADE 3 ID. Useful for when you use a name like “CD 1” over and over.

Name - Location – The sources show alphabetically by name first, then by location name.

Location - BLADE Id – The sources show alphabetically by location name, then by BLADE 3 ID.

Signal Id – The sources show in order of their system assigned signal ID.

Show

This menu allows you to change the information showing in the grid labels for each signal. The choices are:

Name - This is the default. Only the eight character name is shown on the grid label.

Name - Location – Both the eight character name and eight character destination are shown on the grid label.

Signal Id - Name – Both the system assigned signal ID and the eight character name are shown on the grid label.

DESTINATION DETAILS MENU

You have already learned how to make and break crosspoint connections from the grid. Here are some more things you can do. By right clicking directly over the name of a destination, you can bring up the destination details menu.

This menu allows you to access some very common functions:

Choose View

This is same function as mentioned previously. Various filters can be defined to restrict the crosspoint view of the system. This is useful when you have a large system with hundreds of signals and want to work on a small section of it. The filter manager tool of the GUI allows you to define filters based on BLADE 3 ID, signal type (mono, stereo, logic only), location, sources, or destinations and assemble them into Views. The Choose View menu allows you to specify any of the

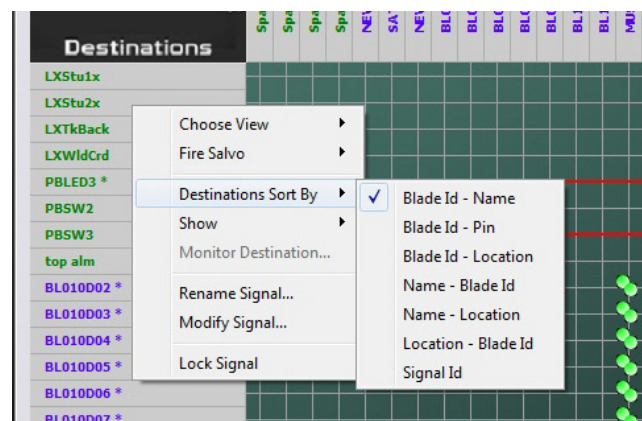

views you have defined, and the crosspoint grid will immediately shrink, removing those signals not part of your selected view.

Hint: if you know you have a signal in your system but it is not appearing in the crosspoint grid, right click on the WheatNet-IP logo and select Choose View / No View. Chances are your signal will now appear in the grid – your filter setting was excluding it.

Fire Salvo

Fire a Salvo is simply a matter of scrolling through the list to highlight the desired Salvo. You will see in Crosspoint window that your connection changes actually happened.

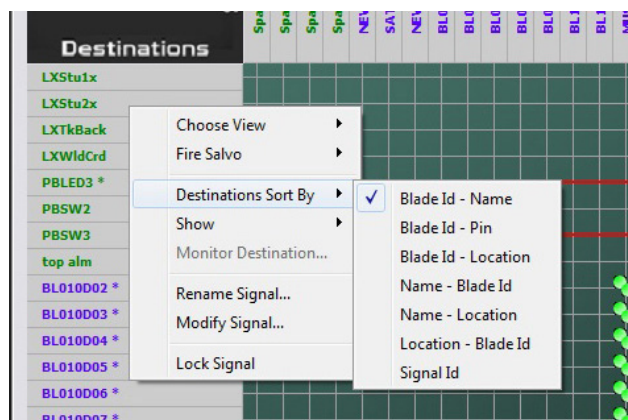

Destinations Sort By

This menu allows you to change the order in the crosspoint grid for the destination signals. The choices are:

BLADE3 Id - Name – This is the default. The destinations show in order of BLADE 3 ID, then alphabetically by name.

BLADE3 Id - Pin – The destinations show in order of BLADE 3 ID first, then connector number.

BLADE3 Id - Location – The destinations show in order of BLADE 3 ID, then alphabetically by location name.

Name - BLADE3 Id – The destinations show alphabetically by name first, then by BLADE 3 ID. Useful for when you use a name like “CD 1” over and over.

Name - Location – The destinations show alphabetically by name first, then by location name.

Location - BLADE3 Id – The destinations show alphabetically by location name, then by BLADE 3 ID.

Signal Id – The destinations show in order of their system assigned signal ID.

Show

This menu allows you to change the information showing in the grid labels for each signal. The choices are:

Name – This is the default. Only the eight character name is shown on the grid label.

Name - Location – Both the eight character name and eight character location are shown on the grid label.

Signal Id - Name – Both the system assigned signal ID and the eight character name are shown on the grid label.

Rename Signal

Choosing this function will open up a Rename Signal window. You will use this function a lot to replace the system auto-generated signal names with names that have more meaning for you. Here you can type a new name, up to eight characters long, for the signal. As soon as you click on the *OK* button, the new name will be broadcast throughout the system and get updated everywhere.

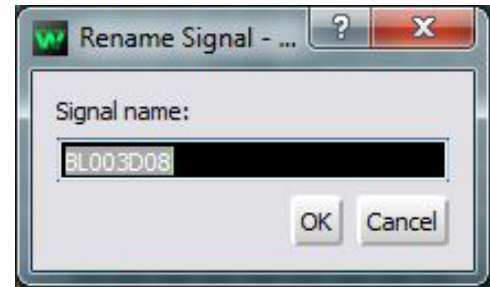

Modify Signal

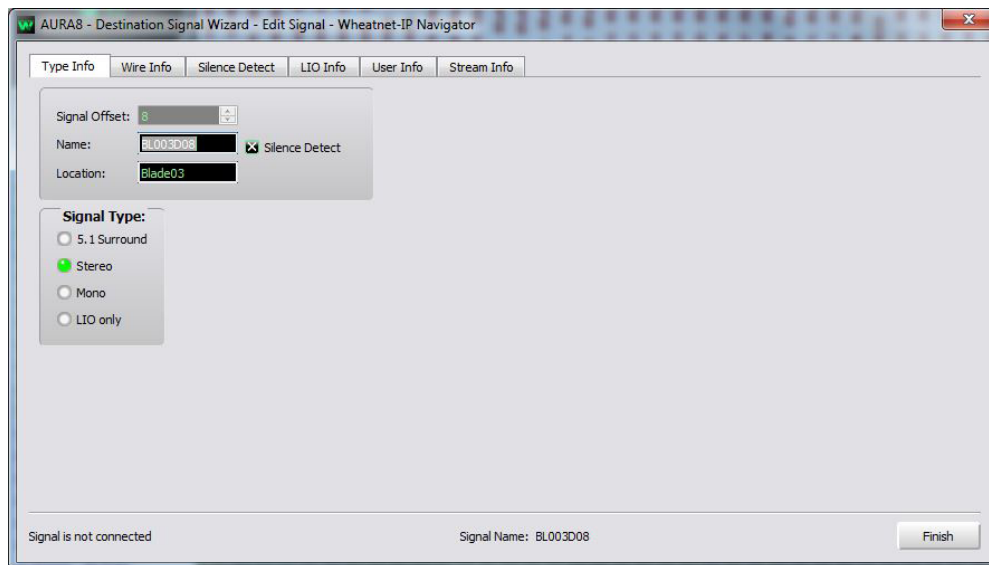

Choosing this function will open the Destination Signal Wizard window. You will also use this function frequently, at least in the beginning. This wizard is used to attach logic, map the audio to the connectors, set up silence sensing, and define the signal type (mono, stereo, etc.). During initial configuration of the BLADE 3, the System Wizard will assign default values for these items:

- Type Info = Mono or Stereo, dependant on which signal template you chose,
- Wire Info = in order, i.e. signal 1 will be mapped to connector position 1, signal 2 will be mapped to connector position 2, etc.
- Silence Detect, if enabled via the checkbox, = -40 dBFS threshold and 20 seconds duration
- LIO Info = none.

You can navigate between these functions by clicking on the tabs at the top of the window.

Type Info: The choices are 5.1 Surround, Stereo, Mono, or LIO only (LIO stands for Logic Input or Output). The first three choices are for various kinds of audio, while the fourth, LIO only, is for discrete logic signals as described in the logic section. You can also use this window to change the signal name, if desired. Finally, there is a check box that will enable the Silence Detect function for this destination signal.

Wire Info: The actual physical connection of the audio destination signal. For an all mono BLADE3, the first output connection on a BLADE3 is called Wire 1 and the last output connection is called Wire 16. If the BLADE3 is all stereo, the first output connection is called Wire 1 LT and the last output connection is called Wire 8 RT. These wire numbers correspond to the connection numbers on the wiring diagrams, and also the rear panel silk screening on the BLADE3 chassis, and define the connector you need to plug into to get the signal. The system defaults to the first signal on the first connector, etc., but you can map them any way you like by selecting the wire in this screen. Note that if you try to map a destination to a connector that has already been used, the GUI will alert you to the error.

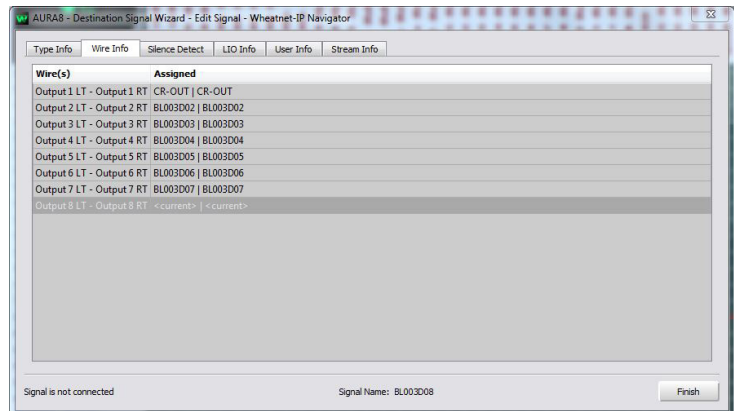

Silence Detect: This function, when engaged, continuously monitors the destination signal for audio content. If the signal falls below the specified threshold for longer than the specified duration, then various things can happen. First, a silence detect alarm will be issued and shown in the Alarms window of the GUI.

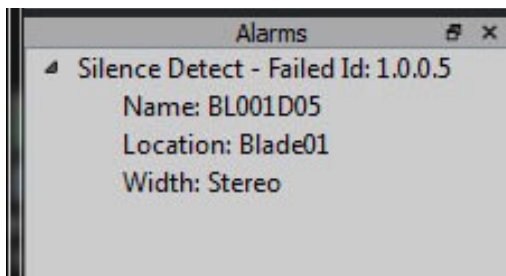
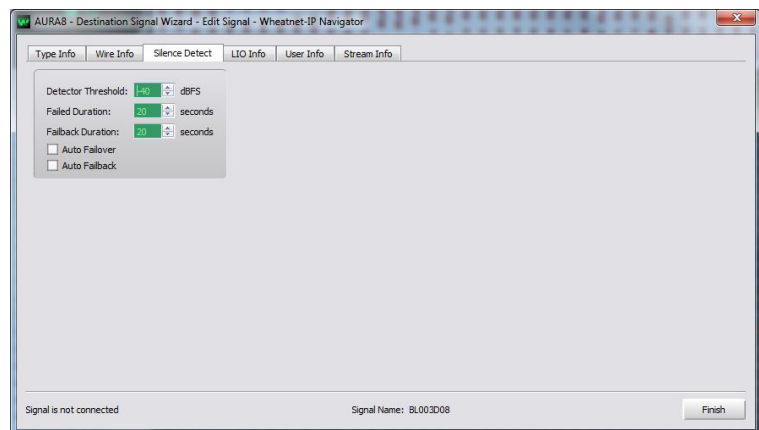

A logic signal can be triggered, and if *Auto Failover* has been selected, a secondary source you have previously defined will be switched to the destination. Finally, if *Auto Failback* has been selected, then the destination will be switched back to the original source if audio has been restored for at least as long as the specified duration. Use this window to define these parameters. Note that for silence detect to work, it must first be enabled in the Type info window by clicking the check box, and the secondary source must be defined using the GUI *Silence Detect* tab for the individual BLADE3.

LIO Info: This window shows the parameters for audio associated logic for the signal. Up to 12 functions can be defined and attached to the audio signal. To activate an audio associated logic signal, click on the LIO Info tab of the signal Wizard screen.

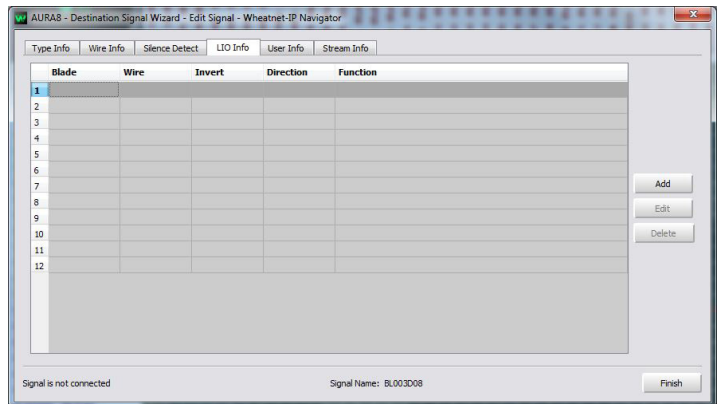

Select *Add* from the right side of the window. Now select the logic port you wish to configure by clicking on the appropriate wire. Select the direction (*Input* or *Output*) and assign a function (machine start, on tally, etc.) from the drop down selection. When you are done click *Apply*, then *Close*. Then click *Finish*. If you find that your logic works backwards, you can click on the *Invert* check box to reverse the sense of the logic. You cannot change the settings in a connected signal.

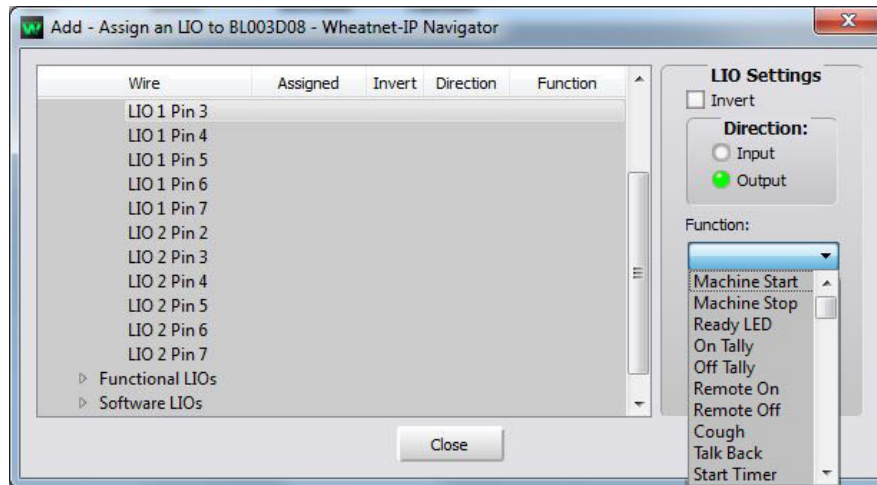

Lock Signal

Select this function to “lock” a source connection to this destination. Once locked, a connection cannot be broken without access to the Navigator GUI. A locked connection is shown on the crosspoint grid as a red line from the destination across the grid.

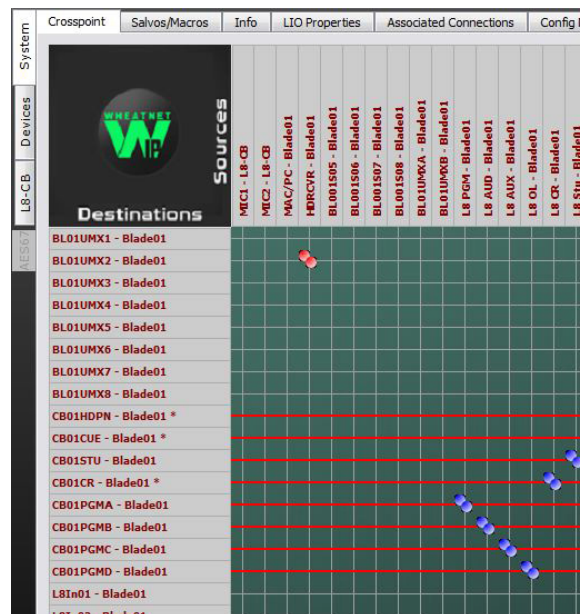

SOURCE DETAILS MENU

In a similar fashion, if you right click over any source name on the crosspoint grid, you will open the source details window.

This menu allows you to access some very common functions:

Choose View

This is same function as mentioned previously. Various filters can be defined to restrict the crosspoint view of the system. This is useful when you have a large system with hundreds of signals and want to work on a small section of it. The filter manager tool of the GUI allows you to define filters based on BLADE 3 ID, signal type (mono, stereo, logic only), location, sources, or destinations, and assemble them into Views. The Choose View menu allows you to specify any of the filters you have defined, and the crosspoint grid will immediately shrink, removing those signals not part of your selected view.

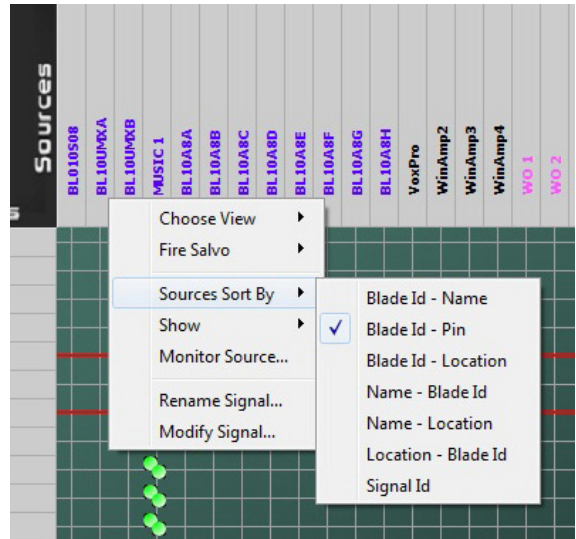

Hint: if you know you have a signal in your system but it is not appearing in the crosspoint grid, right click on the WheatNet-IP logo and select Choose View/No View. Chances are your signal will now appear in the grid – your filter setting was excluding it.

Sources Sort By

This menu allows you to change the order in the crosspoint grid for the source signals. The choices are:

BLADE 3 Id - Name – This is the default. The sources show in order of BLADE 3 ID, then alphabetically by name.

BLADE 3 Id - Pin – The sources show in order of BLADE 3 ID first, then connector number.

BLADE 3 Id - Location – The sources show in order of BLADE 3 ID, then alphabetically by location name.

Name - BLADE 3 ID – The sources show alphabetically by name first, then by BLADE 3 ID. Useful for when you use a name like “CD 1” over and over.

Name - Location – The sources show alphabetically by name first, then by location name.

Location - BLADE 3 ID – The sources show alphabetically by location name, then by BLADE 3 ID.

Signal ID – The sources show in order of their system assigned signal ID.

Show

This menu allows you to change the information showing in the grid labels for each signal. The choices are:

Name – This is the default. Only the eight character name is shown on the grid label.

Name - Location – Both the eight character name and eight character location are shown on the grid label.

Signal Id - Name – Both the system assigned signal ID and the eight character name are shown on the grid label.

Rename Signal

Choosing this function will open up a Rename Signal window. You will use this function a lot to replace the system auto-generated signal names with names that have more meaning for you. Here you can type a new name, up to eight characters long, for the signal. As soon as you click on the *OK* button, the new name will be broadcast throughout the system and get updated everywhere.

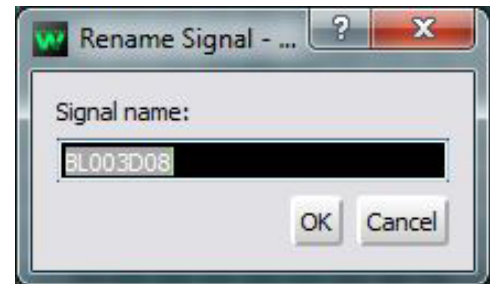

Modify Signal

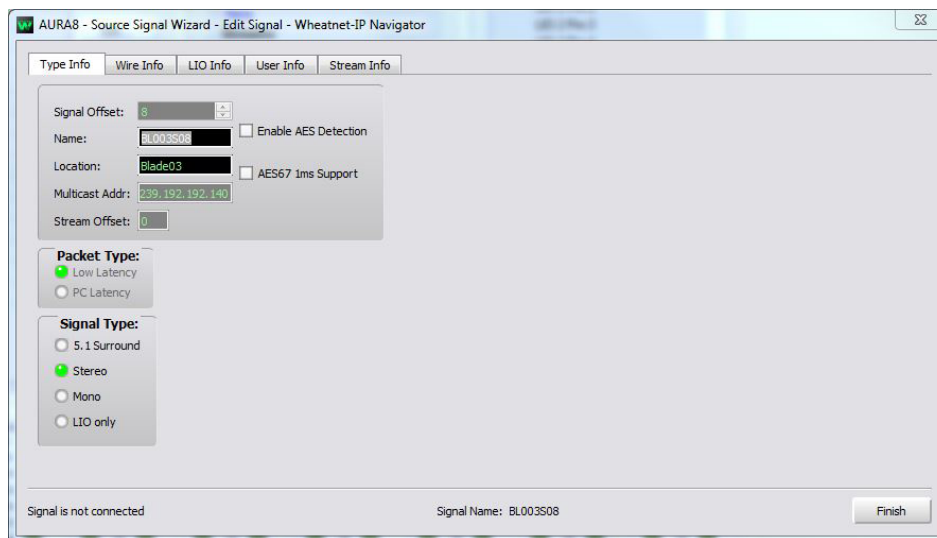

Choosing this function will open the Sources Signal Wizard window. You will also use this function frequently, at least in the beginning. This wizard is used to attach logic, map the audio to the connectors, and define the signal type (mono, stereo, etc.). During initial configuration of the BLADE 3, the System Wizard will assign default values for these items:

- Type Info = Mono or Stereo, depending on which signal template you chose.
- Wire Info = in order, i.e. signal 1 will be mapped to connector position 1, signal 2 will be mapped to connector position 2, etc.
- LIO Info = none.

You can navigate between these functions by clicking on the tabs at the top of the window.

Type Info: The choices are 5.1 Surround, Stereo, Mono, or LIO only (LIO stands for Logic Input or Output). The first three choices are for various kinds of audio, while the fourth, LIO only, is for discrete logic signals as described in the logic section. You can also use this window to change the signal name, if desired.

Packet Type – Low Latency is always selected and greyed out so it can't be changed for normal inputs. PC Latency is always selected and greyed out so it can't be changed for PC Blade Drivers.

Check the *Enabled AES Detection* box to activate the logic function to detect loss of the source's AES reference.

Wire Info: The actual physical connection of the audio destination signal. For an all mono BLADE 3, the first input connection on a BLADE 3 is called Wire 1 and the last input connection is called Wire 16. If the BLADE 3 is all stereo, the first input connection is called Wire 1 LT and the last input connection is called Wire 8 RT. These wire numbers correspond to the connection numbers on the wiring diagrams, and also the rear panel silk screening on the BLADE 3 chassis, and define the connector you need to plug into to get the signal. The system defaults to the first signal on the first connector, etc., but you can map them any way you like by selecting the wire in this screen. Note that if you try to map a source to a connector that has already been used, the GUI will alert you to the error.

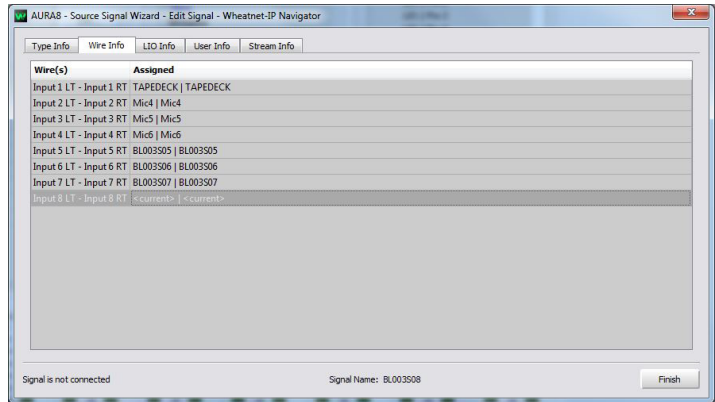

LIO Info: This window shows the parameters for audio associated logic for the signal. Up to 12 functions can be defined and attached to the audio signal. To activate an audio associated logic signal, click on the LIO Info tab of the signal Wizard screen. Select *Add* from the right side of the window. Now select the logic port you wish to configure by clicking on the appropriate wire. Select the direction (*Input* or *Output*) and assign a function (machine start, on tally, etc.) from the drop down selection. When you are done click *Apply*, then *Close*. Then click *Finish*. If you find that your logic works backwards, you can click on the *Invert* check box to reverse the sense of the logic. You cannot change the settings on a connected signal.

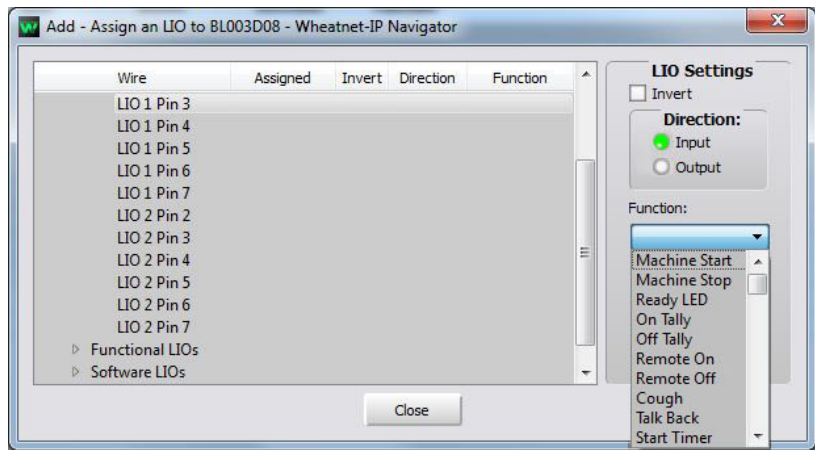
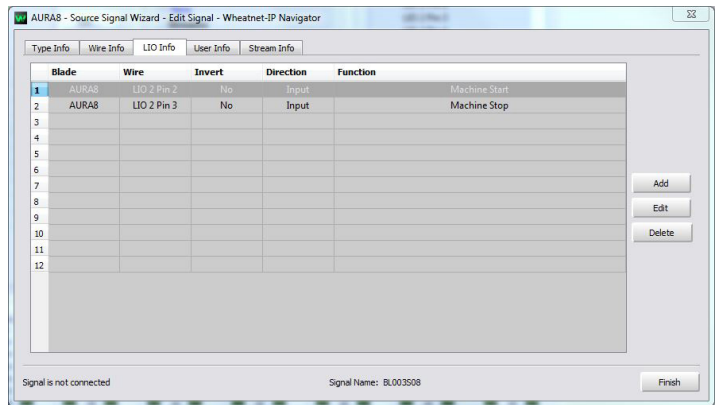

Salvos/Macros Tab

In the WheatNet-IP system, you can group up to 100 connection states into a Salvo and then trigger the one Salvo instead of the 100 individual connections. This capability is especially useful for systematic events involving multiple connection changes. Going from your late night automated set up into your Morning Drive Show is a good example. It may involve switching out automation from your air feed, bringing in a control surface, a bunch of mics, switching headphone feeds, connecting automation playback decks, etc. The good news is that this set up tends to be the same every day. Go ahead and group all of these connections into a Salvo, and instead of all the patching and cross connecting you would have had to do in the old analog days, you can simple click on a menu selection (or press a button if you map the Salvo to an LIO port) and make these wholesale changes quickly and reliably. It's one of the great benefits of having a networked system in the first place.

Here's how to do it. Click on the Salvos/Macros tab, and a new window opens. It shows a crosspoint grid with scroll bars, like you have seen before, but there are differences. A new button area labeled *Salvos*: has appeared on screen between the system tabs and the crosspoint grid itself. Also, the grid background shows the legend *Salvo Edit Screen*, and any dots on the grid representing connections will be in a new color. By the way, the trick you learned earlier about right-clicking on the WheatNet-IP logo on the crosspoint grid also works here. It will bring up some of the same menus that change how the signals are labeled and sorted on the grid (by name, ID, etc.). Any of the filters you've defined for restricting the crosspoint view will also be usable on the salvo grid.

In the left part of the salvo button area is a selection window. Initially it will say *Salvo 1 (empty)*. As you define Salvos, their names will appear in this selection window. Executing a Salvo is simply a matter of scrolling through the list in this selection window to highlight

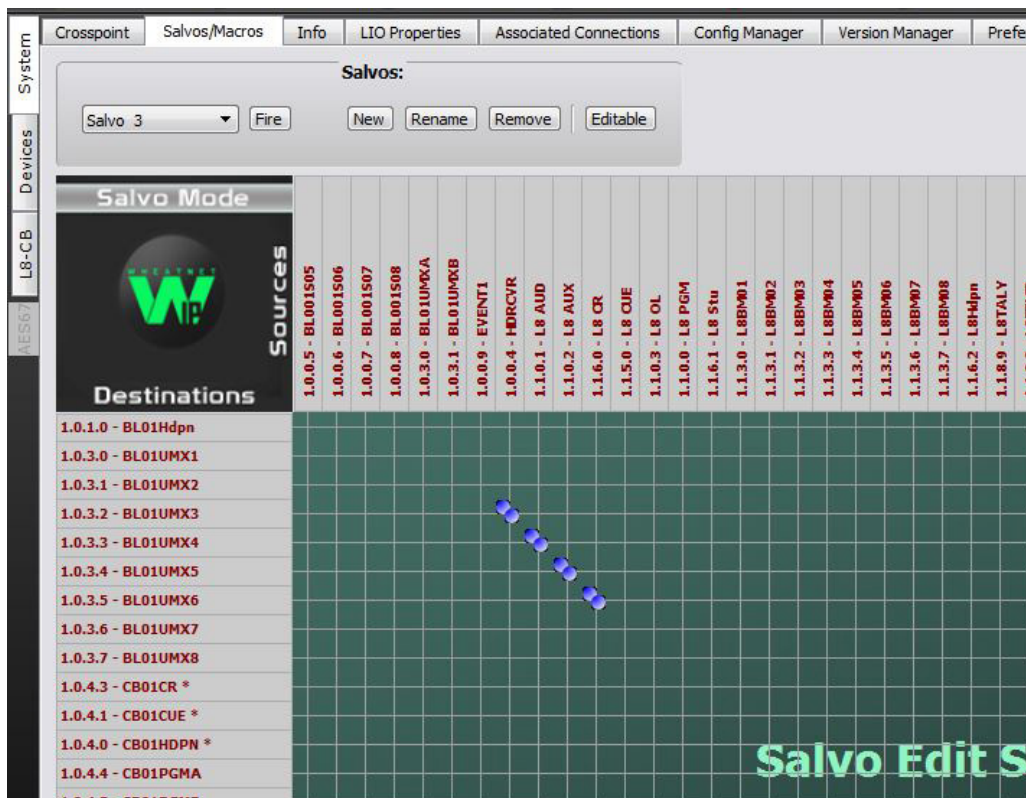

the desired Salvo, and then clicking on the *Fire* button. Don't be alarmed if you don't see any crosspoint changes on the grid; remember this is the Salvo Edit Screen. You can click on the System Crosspoint tab (or use the floating Crosspoint window) to verify that your connection changes actually happened.

Click back on the System Salvos/Macros tab if you aren't already there and click on the *New* button in the *Salvos:* button area. A blank grid will appear, and a new salvo name, "Salvo x" will be added to the salvo selection window where "x" is the next salvo number available. In the case of the first salvo created, the default name will be "Salvo 1" and so forth. Click on the button labeled *Editable* to highlight it. Click on any source - destination connections you want to include in your salvo and a dot will appear on the appropriate grid intersection. If you have any destinations you simply want to disconnect and not use, right click on the destination name and select *Disconnect Destination*; a solid line will be drawn across the grid at the destination, indicating that there are no sources connected to the destination. When you are finished, you can click on the button labeled *Rename* if you would like to overwrite the default salvo name with something more identifiable, say for instance "Morning Show." A good name for the salvo is very useful in other parts of the Navigator GUI, such as the LIO mapping area where you can assign salvos to buttons. You'll see a list of salvo names exactly as shown here in the salvo select window.

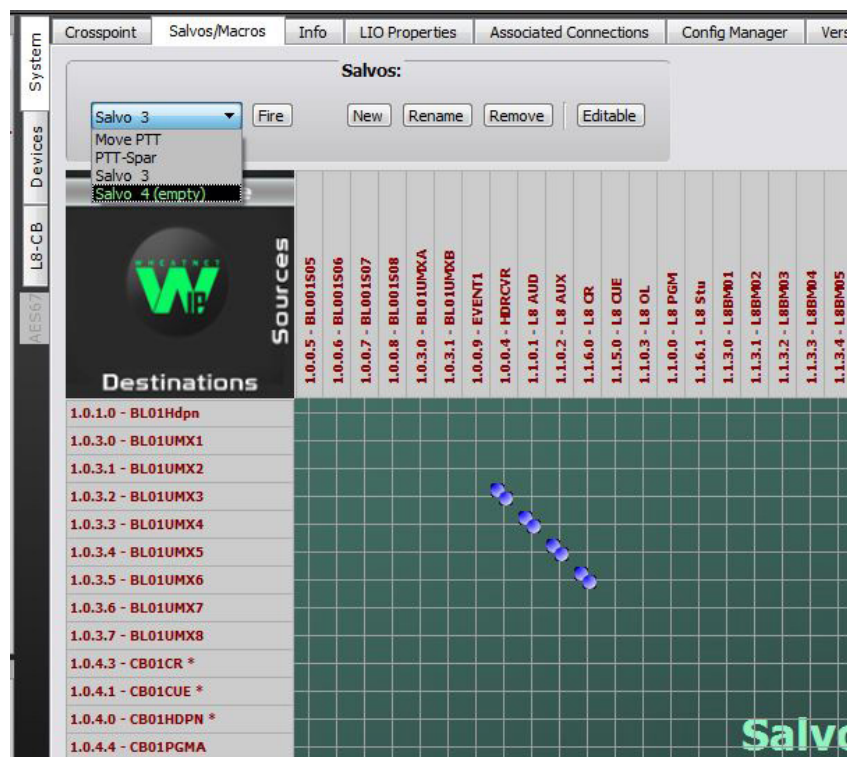

A few final hints about salvos. When you switch to the Salvos/Macros tab, the screen will go to the view from the last time the salvo window was opened. Also, if you find you can't change connections on the grid, make sure you've clicked the *Editable* button first. We've chosen to make the salvo edit process take two steps so as to avoid inadvertent changes caused by accidental mouse clicks during casual viewing. Finally, salvos are executed very quickly; however, there is a sequence to them. Connections changes are made in the order they were created in the salvo, so if the order is important to you, keep this in mind while creating the salvo.

Info Tab

Clicking on the Info tab removes the crosspoint grid from the main part of the GUI screen and opens a new window. Within this window are four subwindows used for setting up important system functions.

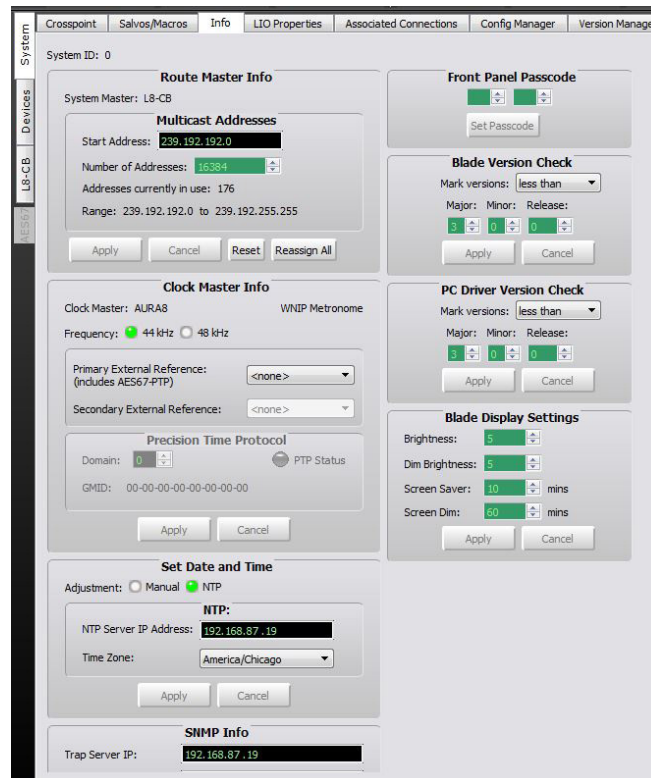

Clock Master Info

In the WheatNet-IP system, in order to keep all of the audio channels in all of the connected BLADE 3s and PCs synchronized, one of the BLADE 3s is designated as “system clock master.” This is something that is normally done automatically by the system at start up time, but this window allows you to deliberately specify the clock master. Why would you want to do this? In the case where you are trying to synchronize the entire system to some external AES master clock. By feeding the external clock reference into AES input 8 of one of your digital BLADE 3s and selecting that BLADE 3 in the *Primary External Reference* window, you will force the system to slave off of the timing reference on input 8 of the designated BLADE 3. We chose input 8 as the reference input because the external clock reference chews up an audio channel, and input 8 seems less valuable than, say, input 1. Note that you can also specify another BLADE 3 to be a *Secondary External Reference* for back up. In this case if you provide the same AES reference signal to the secondary clock master BLADE 3, the system will stay locked to the external reference should the primary clock master BLADE 3 loose power or otherwise go down.

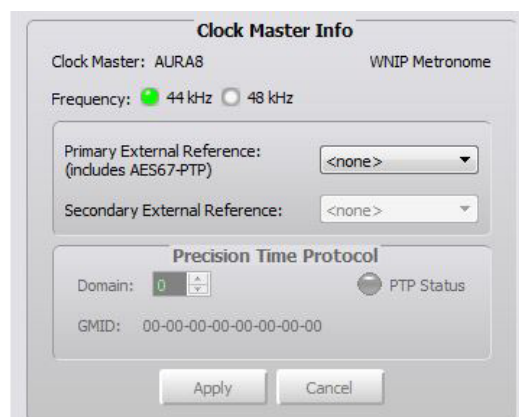

This window also has two buttons to set the system clock rate to be either 44.1K or 48K. While this selection is not so significant for AES digital input signals because all AES inputs in BLADE 3s are equipped with sample rate converters, it does set the sample rate of all of the system's AES digital outputs. Most modern digital devices can accept various sample rates, but there are still some out there (primarily Automation PCs) that require a specific sample rate.

Choose the settings you want in this window and click on the *Apply* button to execute them.

How does this all work? The system will synchronize to the BLADE 3 that is the primary clock master. This will be indicated in the System Pane of the GUI by a BLADE 3 wave signal overdrawn on the appropriate BLADE 3 icon. There is also a front panel LED that will also be lit to show that the BLADE 3 is the primary clock master. That BLADE 3 will use whatever AES signal that is connected to input 8 as the clock reference; if there is nothing connected to input 8, or if the device connected to input 8 goes away, it will use its own internal reference. If the primary clock master BLADE 3 itself should power off, become disconnected, or otherwise cease to function, the secondary clock master will take over so be sure to connect your external AES reference signal to input 8 of the secondary clock master too if you need to keep the system locked to the external reference.

For AES67 and PTP Clock setup please refer to the “WheatNet-IP and AES 67” Appendix 11 of this manual.

Set Date and Time

This window is used to set up the date and time of day for the WheatNet-IP system. There are two modes the system can operate under, manual and NTP. The mode is chosen with the *Adjustment:* buttons.

In NTP mode, each BLADE 3 and surface will subscribe to a network time server and maintain date/time synchronization with the network server.

In Manual mode, you have two choices. You can specify the date and time yourself by clicking a section in the window and clicking on the up/down arrows to advance or backtrack the section, or you can take a short cut and simply click on *Use this PC's time*. In that case the time settings on the GUI PC will be distributed to the BLADE 3s and control surfaces. It will take a little while after making your selection for everything to get updated.

The system date and time settings aren't visible in the system during normal operation but you should still take the time to set this carefully. Each BLADE 3 maintains a log which can be useful for checking and troubleshooting problems. This log has a date and time stamp on it that is derived from the system date/time. Also, each control surface has a time of day display that is controlled by the system date/time.

Choose the settings you want in this window and click on the *Apply* button to execute them.

The screenshot shows the 'Set Date and Time' dialog box with the 'NTP' radio button selected. The 'Adjustment:' section has 'Manual' unselected and 'NTP' selected. The 'NTP Server IP Address:' field contains '192.168.87.19'. The 'Time Zone:' dropdown menu is set to 'America/Chicago'. There are 'Apply' and 'Cancel' buttons at the bottom.

The screenshot shows the 'Set Date and Time' dialog box with the 'Manual' radio button selected. The 'Adjustment:' section has 'Manual' selected and 'NTP' unselected. The 'Manual:' section shows a date and time field with 'Jul 6, 2018 11:04:56' and up/down arrows. Below it, the checkbox 'Use this PC's time.' is checked. There are 'Apply' and 'Cancel' buttons at the bottom.

Front Panel Passcode

In a similar vein, you can restrict access to all front panel functions of the BLADE 3s with passwords, such as REBOOT, FACTORY RESET, IP ADDRESS, etc. These are the functions that can significantly alter the functionality of a BLADE3, so their access can be controlled with passwords. The passwords are all numbers because users will use the front panel encoder to enter them. Use the up/down arrows or else type the numbers in directly to specify the password. Useable values are in the range 0 - 255.

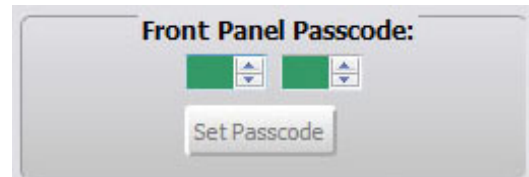

Once you have completed the settings you want in this window, click on the *Set Passcode* button to execute them. Users attempting to log into the sensitive areas of a BLADE 3 via the front panel will be prompted for a password which will prevent their access unless entered correctly.

Version Check

Gives you visual notification for the chosen range of the BLADEs or PC Drivers versions in your system.

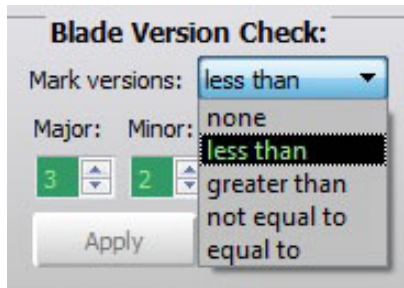

Choose a range of the versions from the *Mark Versions:* drop box. Enter desired version in the *Major:*, *Minor:*, and *Release:* boxes, then click the *Apply* button.

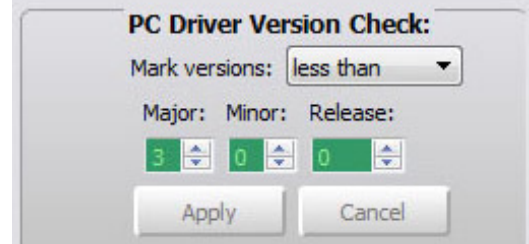
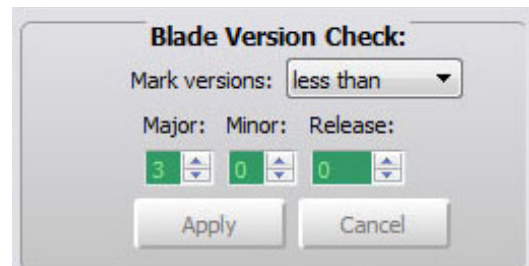

Red dot indicator is displays next to the BLADEs in the System Pane for given range.

Blade Display Settings

The brightness of the displays can be controlled globally by the settings in this region. The displays brightness varies from a setting of OFF to a maximum of 15. The displays also have a screen-saver mode. After a specified time, the display brightness will be automatically dimmed to an alternate brightness setting. When a button is pressed or an encoder is turned, the brightness returns to the normal level.

- **Brightness** – This control specifies the normal brightness level of the display. The possible values vary from a low of OFF to a high of 15.
- **Dim Brightness** – This control specifies the brightness level to be used when the displays are in dim mode. The possible values vary from a low of OFF to a high of 15.
- **Screen Saver** – This control specifies how long (in minutes) to wait before entering screen-saver mode. The allowed values range from Disabled to 240 minutes.
- **Screen Dim** – This control specifies how long (in minutes) to wait before display is automatically dimmed. The allowed values range from Disabled to 240 minutes.

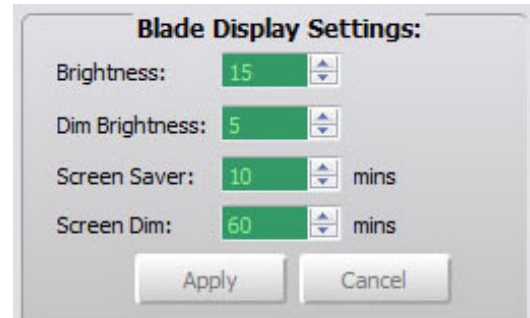

LIO Properties Tab

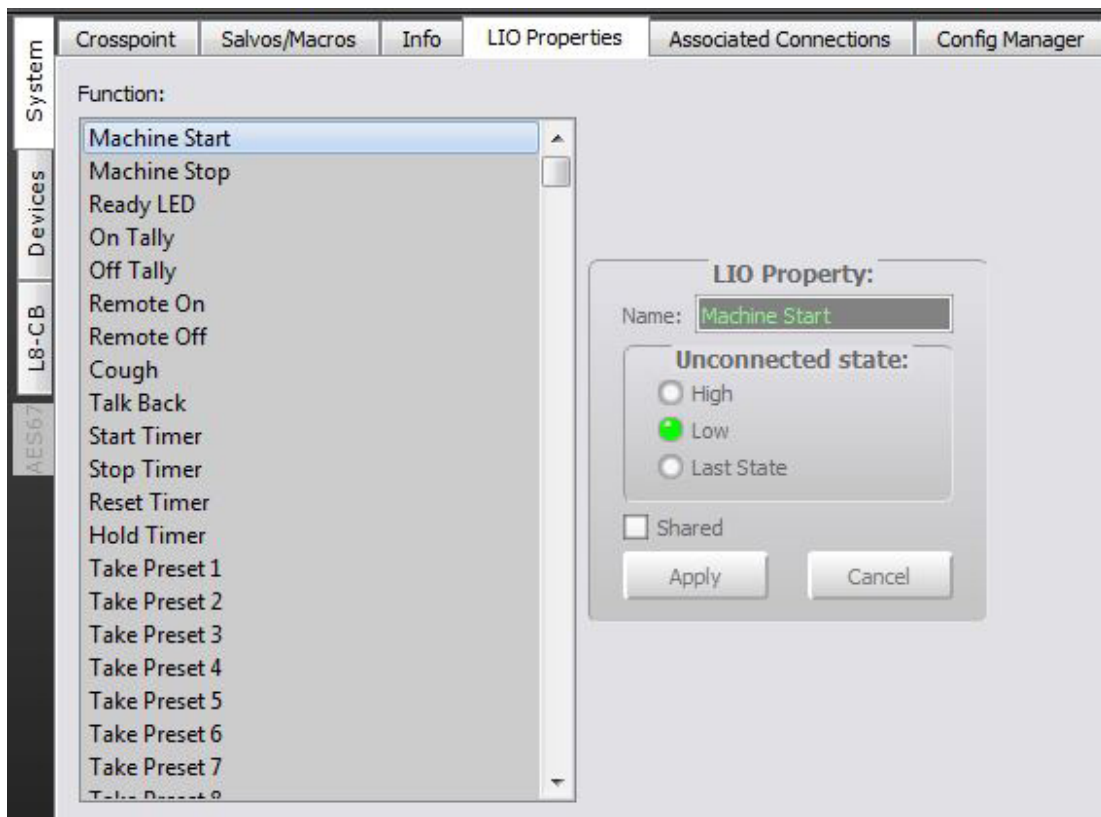

This screen is used to set certain logic output function properties. The logic system in WheatNet-IP works by using crosspoint connections between logic inputs and logic outputs to establish a logic path. If a logic source, for instance a switch, is crosspoint connected to a logic destination, say relay #1, and they both have been defined with the same function (start, remote on, user 23, etc), then the switch will trigger relay #1 as long as the crosspoint connection is maintained. If that connection is broken and, instead, a connection is made to a different logic destination, say relay #2, then the switch will trigger relay #2. The question then becomes “How should a logic output behave when it is disconnected from a logic input?” The Navigator GUI allows you to specify this behavior separately for each logic function (starting with function User 1). This capability can be very useful with some types of machines that also have front panel controls. These controls may not function if the remote control logic ports of the machine are held in the wrong state. The choices for the disconnected state of a logic output are:

- **High** – When the output is disconnected from a logic input it will go high.
- **Low** – When the logic output is disconnected from a logic input it will go low. This is the default.
- **Last State** – When the logic output is disconnected from a logic input, it will stay in whatever state it was last in.

To change from the default, select the logic function desired from the scrolling list. Its disconnect state will appear in the “Unconnected state:” window. Click on the button to make your choice, then click on *Apply*.

The LIO Property: section of the window also has a *Shared* check box. It is rather easier to explain the use of this check box by first explaining what we mean by the opposite term, “not shared.” The factory defined logic functions all work in a “not shared” mode. This is best described using a specific example from a system that includes one or more surfaces.

Let’s say that you have a CD player signal with an associated “Machine Start” logic output. This would typically be the case when you want the CD player to begin playing a cut when a surface fader’s ON button is pressed. But what happens when that same CD player also gets assigned to a different fader, say on another surface in a different studio? We normally would not want an ON button press on this second fader to fire the Machine Start logic while the cut is playing, possibly on air, on the first surface, since it might restart the cut, or switch to a new cut. In fact, using the factory defined functions, like “Machine Start,” we lock out control from additional faders when the first fader is turned on, rather than “share” the logic signal.

Having said that, checking the “Shared” check box for a user defined logic signal allows the signal to be shared among users of the signal. In the above example, with both faders on, either fader’s ON button could fire a shared user defined function at any time.

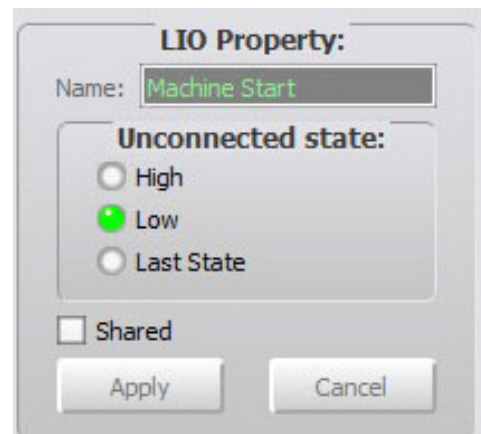

Associated Connections Tab

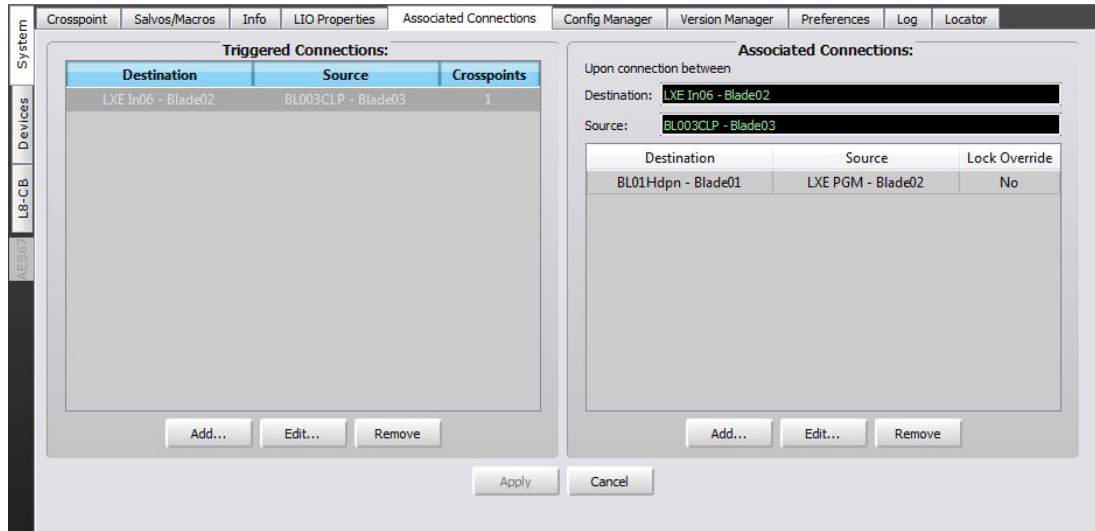

Associated Connections feature is useful for callers, codecs, networks, remote broadcasts and live talk shows that require a mix-minus. With this, operators can create a predetermined back haul, IFB feed or mix-minus to each device based on its location in the system and the fader to which it is connected. For a shared resource connected to your system, such as a codec, the software will “automagically” give the proper return feed to the codec based on its source connection. When a base connection is made, up to ten additional connections can automatically follow. This significantly helps streamline studio routing, phone, and codec work flow.

Triggered Connections

Here is where the main connection is specified. Anytime this connection is made, all of the specified associated connections will also be made. The trigger can also be a Disconnect.

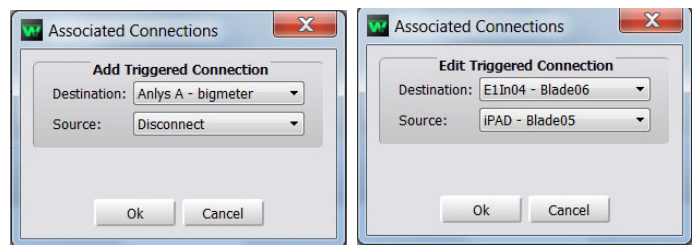

Associated Connections

Here is where the associated connections are specified. Note there is a “Lock Override” check box. If a specified destination is connected to some other source and that connection has previously been locked, an associated connection event will not change the locked connection unless this box has been checked.



Config Manager Tab

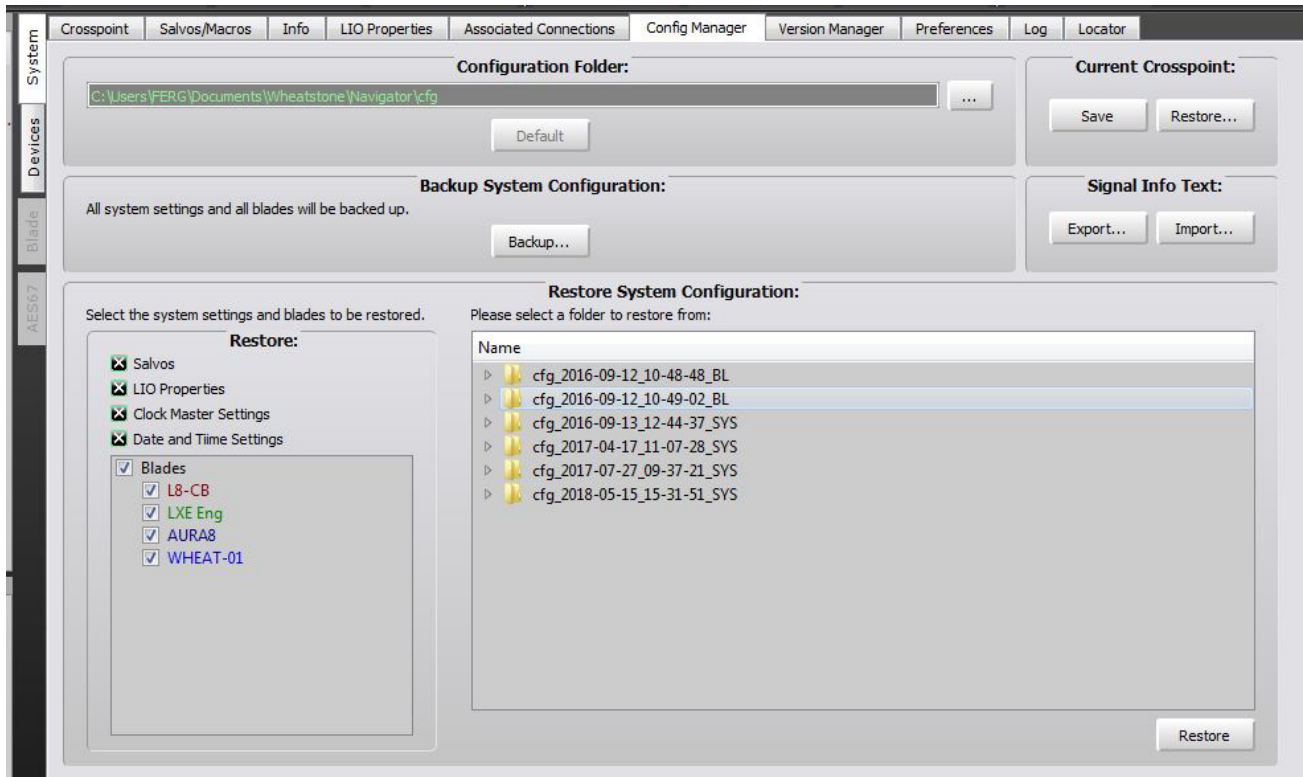

This screen allows you to specify a directory on the GUI PC to be used to Archive system information, to back up data to the directory, or restore data to the system from the directory. As in any digital system, it's a good idea to back up critical information regularly.

In the WheatNet-IP system, there are two classes of data for archiving, system data such as salvos, clock, date, and password information, LIO properties, and so forth, and BLADE 3 data such as signals, names, silence detect parameters, logic port mapping, etc. The System Config Manager window has several sub windows.

Configuration Folder

In this window you choose the specific directory for the Archive. The default directory is shown in the box, or you can click on the “...” button to open another window to browse for a different directory. If you decide to change the default directory, browse for and highlight the new one in the box and then click the *Default* button.

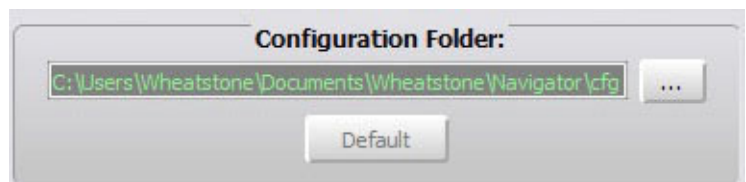

Backup System Configuration

This window is quite simple. Click on the *Backup...* button and the system information will be sent to a new, automatically named, directory created in the directory specified in the “Configuration Folder” window.

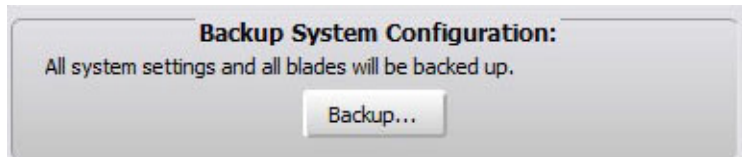

Current Crosspoint

This window is used to save the Current Crosspoints to a file stored locally on the PC or restore Crosspoints from one of the saved files.

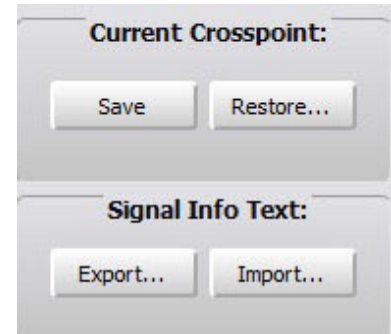

Signal Info Text

This window is used for exporting the Signal Info data to the Archive or importing it from the Archive back to the WheatNet-IP system.

Restore System Configuration

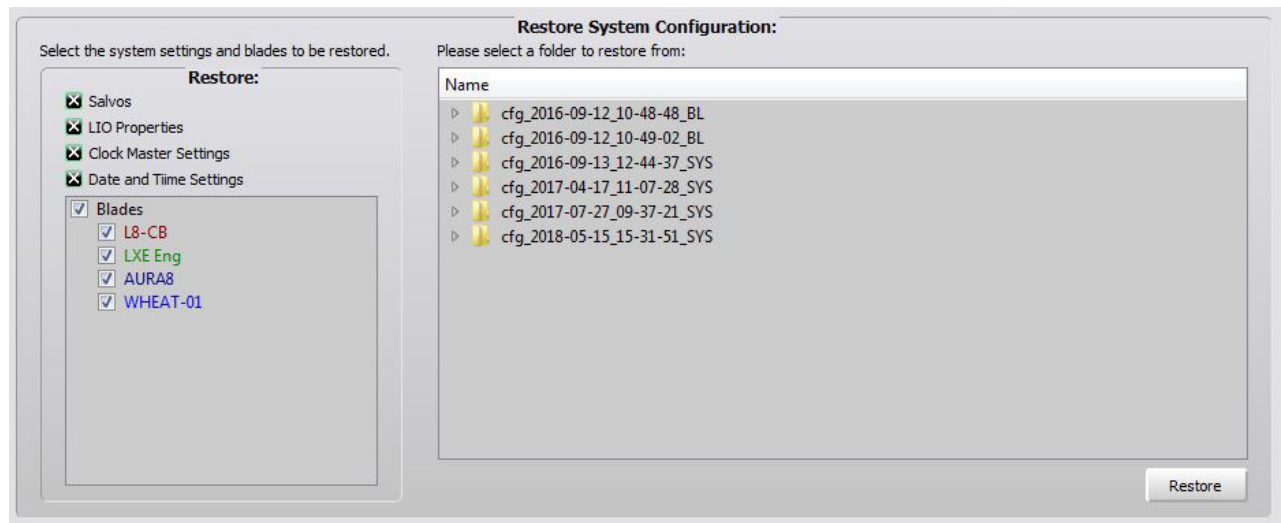

This window is used for restoring data from the Archive back to the WheatNet-IP system. In the right hand pane you select a directory to restore from. You are given four choices of data in the “Restore:” section, Salvos, LIO Properties, Clock Master Settings, and Date and Time Settings. Click on the check boxes to select any or all of these. In the Blades section you can click any or all BLADEs to be stored.

Once you have made your selection, click on the *Restore* button.

Version Manager Tab

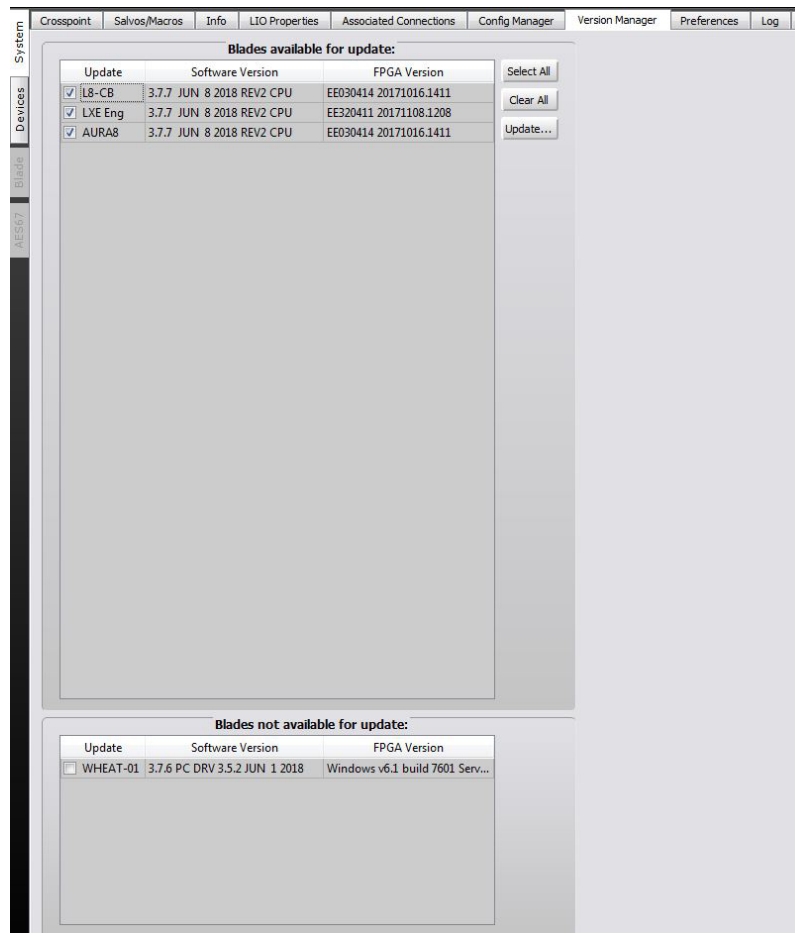

The Version Manager tab opens an information window showing at once the current software and firmware versions of all BLADE 3s in your system. As the WheatNet-IP system evolves over time, there will no doubt be future updates that increase or improve functionality of the BLADE 3. This tab is a convenient way to keep track of the current versions on the BLADE 3. It also can be used to update the BLADE 3 with new versions.

Choose the BLADE 3 you wish to update from the “Blades available for update” section or press the *Select All* button to select all BLADE 3s at once, then press the *Update...* button to browse to the directory on your PC that contains the version you wish to upload to the BLADE 3(s).

Click on a file name to highlight it and then click on the *Open* button. The file will be uploaded to the BLADE 3(s). Note that the BLADE 3(s) must be rebooted in order for the new software file to actually run on the BLADE 3(s). Either power cycle the BLADE 3(s), or chose “Reboot” from the front panel menu, or use the individual Reboot Blade option in Navigator for each BLADE 3, or use the System0>Reboot All Blades option in Navigator.

After uploading and rebooting, check the Version Manager tab to make sure the desired software version is running.

The “Version Manager” form also display a list of “Blades not available for updates”. This includes items that cannot be updated from Navigator, such as PC Driver Blades.

Preferences Tab

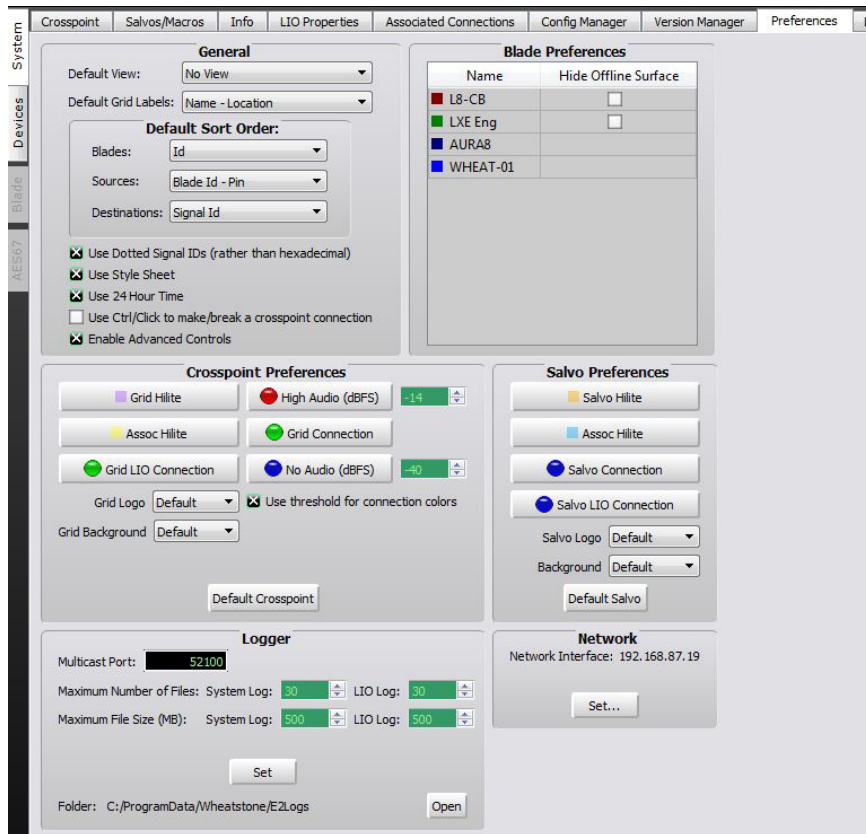

This window is used to change the look and feel of the Navigator GUI. Within it are several sections that control a number of default settings of the program.

General Section

Default View

Clicking in this box opens a drop down window listing all of your defined views. Chose one of them to be the default and this view will automatically be applied every time you open the GUI, showing the subset of the system as specified by the view. This function can be useful if you regularly run the system in a partial state. Some examples might be if you have a TV - Radio combined system and don't want your radio staff distracted by the TV half and vice versa. Or perhaps you are in a total rebuild situation with some studios active and on-air while others are still under construction; a situation all too common these days. Be cautious about applying a default view as you can easily overlook the parts of the system masked by the view. The normal default view setting is "No View."

Default Grid Labels

Clicking in this box will open a drop down window with choices to set the information displayed as the crosspoint grid labels. The four choices are:

- **Name** – The signals are identified on the crosspoint grid by their eight character user defined name.

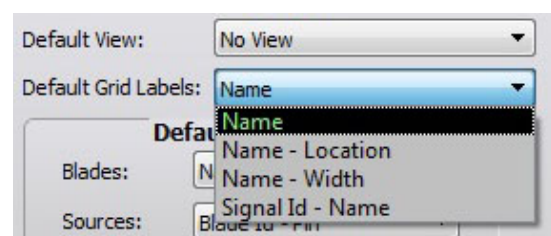

- **Name - Location** – The signals are identified on the crosspoint grid by both their eight character name and the eight character user defined location. Including the location information helps keep track of the signals, especially if you have chosen to use the same name for different signals.
- **Name - Width** – The signals are identified by both their eight character name and audio width as defined for each signal – stereo, mono, lio.
- **Signal ID - Name** – The signals are identified on the crosspoint grid by both their signal ID and their eight character name. This mode is especially useful during set up as each signal is clearly identified by its ID. These are set by the system and absolutely unique. This setting is automatically selected when the GUI is installed.

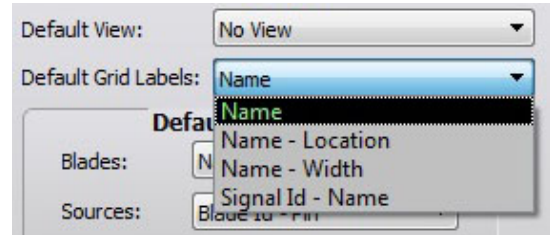

Default Sort Order

This section allows you to specify a default sort order for the way sources and destinations are displayed. The choices are:

- **BLADE Id - Name** – This is the default. The signals show in order of BLADE3 ID then alphabetically by name.
- **BLADE Id - Pin** – The signals show in order of BLADE3 ID first, then connector number.
- **BLADE Id - Location** – The signals show in order of BLADE3 ID, then alphabetically by location name.
- **Name - Blade Id** – The signals show alphabetically by name first, then by BLADE3 ID. Useful for when you use a name like “CD 1” over and over.
- **Name - Location** – The signals show alphabetically by name first, then by location name.
- **Location - BladeId** – The signals show alphabetically by location name, then by BLADE3 ID.
- **Signal Id** – The signals show in order of their system assigned signal ID.

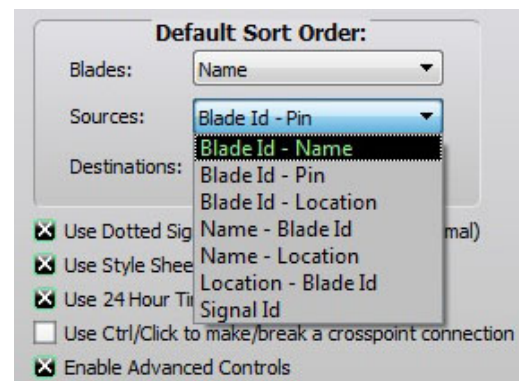

Check Boxes

The functions are:

- **Use Dotted Signal IDs** – Changes how the Signal IDs are displayed between hexadecimal and standard decimal forms.
- **Use Style Sheet** – Changes background color from grey to white for highest contrast.
- **Use 24 Hour Time** – Changes between 12 and 24 hour time format.
- **Use Ctrl/Click to make/break a crosspoint connection** – Enables having to hold Ctrl down to change a crosspoint on the grid.
- **Enable Advanced Controls** – Enables the Logger options on the System *Preferences* tab, and Master Preference options on each Blade *Blade Info* tab.

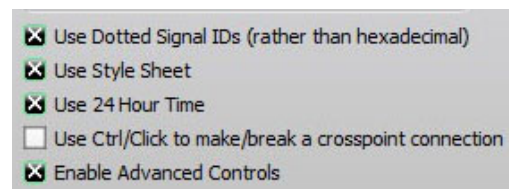

Colors

There are three section in the Preferences window that have to do with customizing the visual presentation of the Blades and crosspoint grid:

- Blade Preferences
- Crosspoint Preferences
- Salvo Preferences

Blade Preferences	
Name	Hide Offline Surface
Blade02	
Blade03	
Blade04	
Blade10	<input type="checkbox"/>
uPhones	
Blade15	
Blade36	
BLD055	

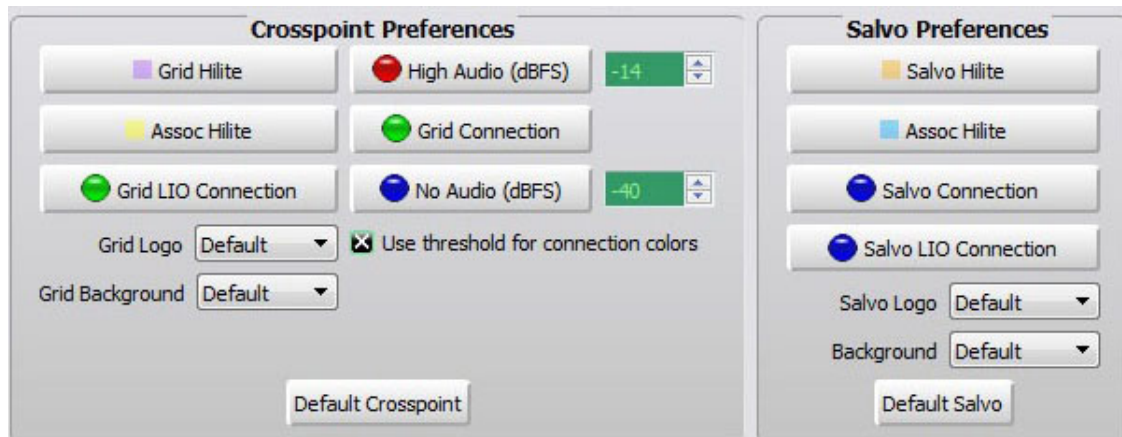

Begin by making sure that the “Use Style Sheet” check box has been checked. This tells the software to use richer, more colorful graphics for the grid at the penalty of slightly slower performance. If this check box had not been checked, you will have to restart the Navigator GUI software after you change it. Most of the color functions are disabled when the “Use Style Sheet” box is unchecked. If you find that your GUI doesn’t display colored windows as have been shown in this manual, chances are the “Use Style Sheet” box is unchecked.

Clicking on any of the feature boxes opens up a Select Color window, giving you the opportunity to customize the feature color as you see fit. You have millions of colors to choose from.

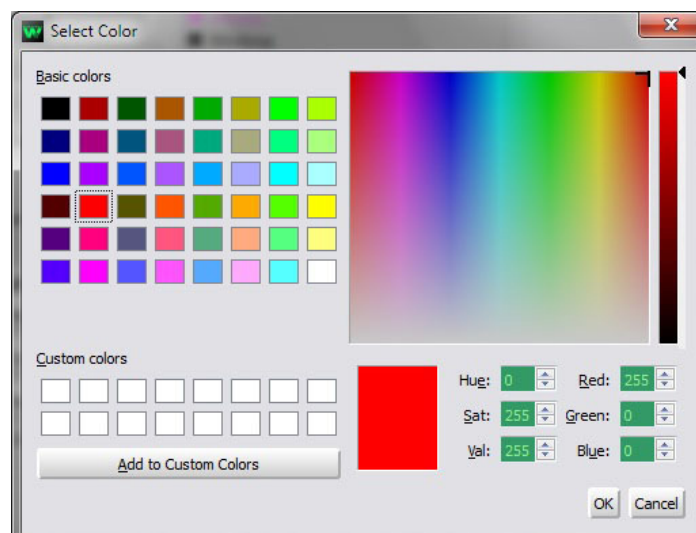

By manipulating the colors of the crosspoint grid you can radically change the look of the GUI, from a bright, bold, hard to miss look

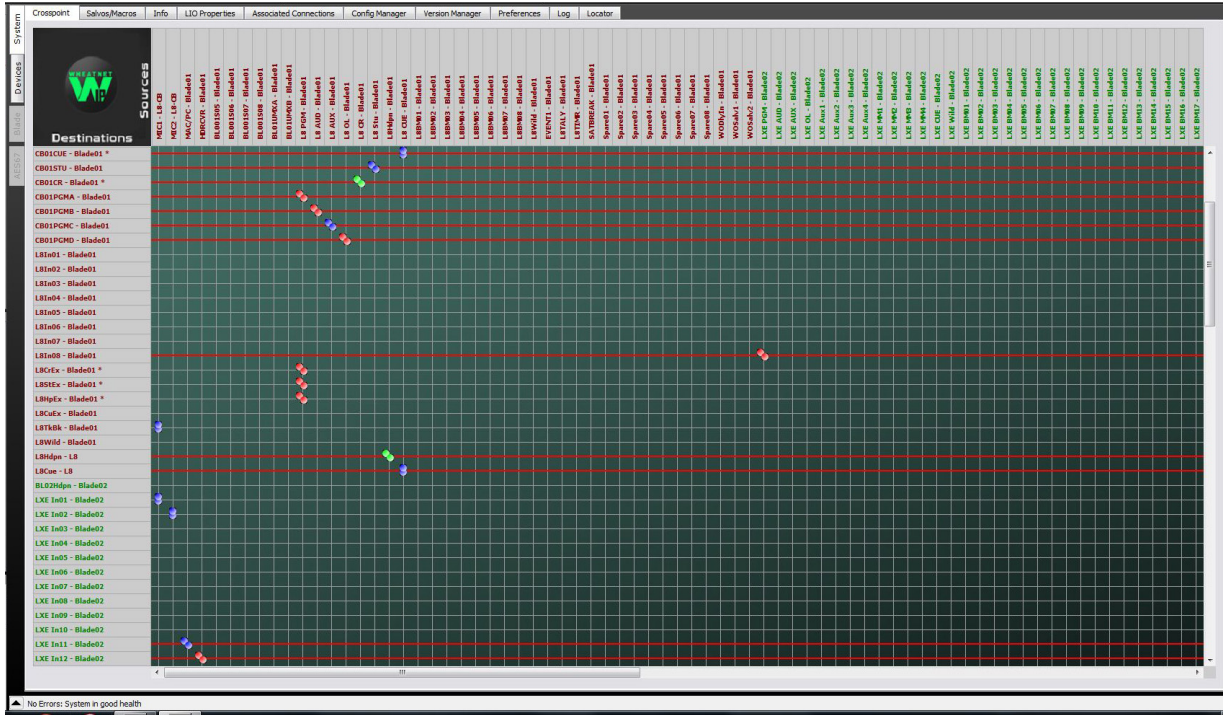

to a soft, subtle, easy on the eyes look.

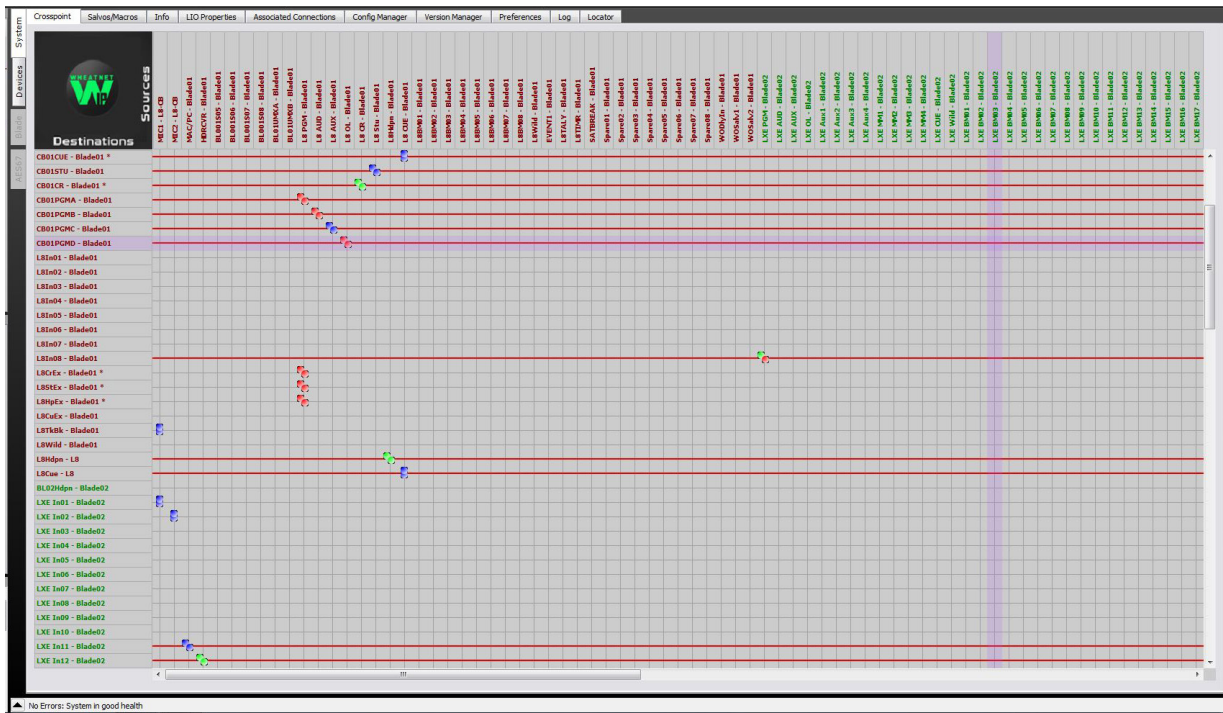

There are lots of possibilities, its all up to you.

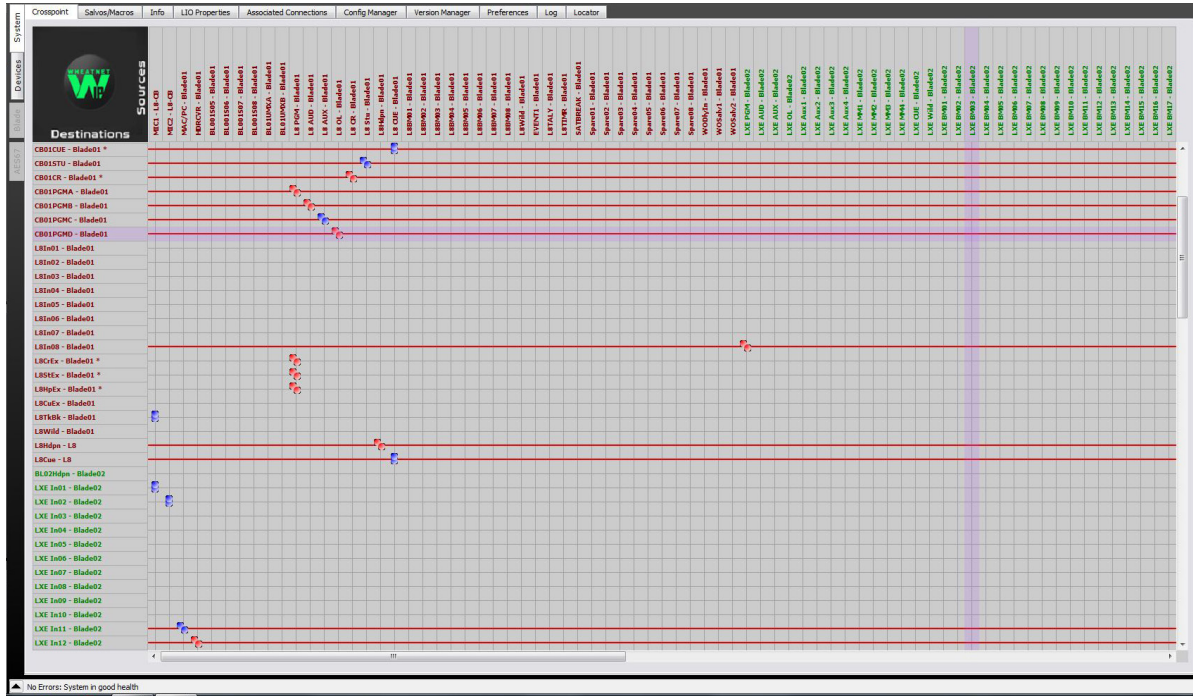

Blade Preferences

The Navigator GUI has been designed to simplify the organization of large complex systems. To that end, the system will automatically assign a different color for each BLADE3 and its associated signals. That is to say, as soon as a BLADE3 is brought into the system, it is given a color and the BLADE3’s name will be listed in the System Pane printed in this color. Additionally, the BLADE3’s source and destination names will appear in the crosspoint grid in this same color. This color coding makes it easy to quickly identify visually which signals go with which BLADE3.

Now comes the good part. Because the System Preferences window allows you to customize these colors, you can set up your own color schemes for identifying the signals. Because a WheatNet-IP system can be brought up so quickly, you might have a little extra time for organizing the GUI with colors. Here are some suggestions:

Make each station’s part of your complex a different color as in WXXX air, production, and talk studios are all red, WYYY’s are all blue, WZZZ’s are all green, and the common signals in your rack room are all teal. You can further enhance the presentation by making the different studios in the station different shades of the same color, with the Air studio brightest.

You can key your color scheme to physical location, such as all the BLADE3s on the first floor are one color, all the BLADE3s on the second floor a second color, and all the BLADE3s in the rack room a third color. Again you can use degrees of these colors to further distinguish them.

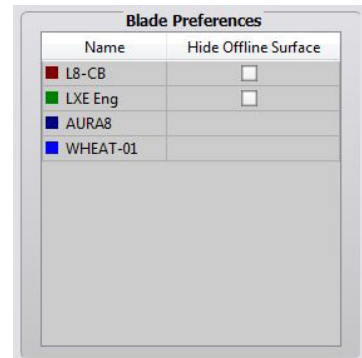

Another possibility is to use colors to designate functions, say, all analog BLADE 3s are blue, all digital BLADE 3s are red, all analog/digital BLADE 3s are purple, and all engine BLADE 3s are green.

Logger

This portion is only visible if the check box *Enable Advanced Controls* is checked. This controls the System and LIO log options. The *Multicast Port* is already set for you. System and LIO logs are saved separately but in the same fashion. A new log file is created when either the date changes or the maximum file size is reached. You can choose the *Maximum Number of Files* for each log type to be saved by adjusting the associated numeral value. You are also able to set the *Number File Size* for each log type by adjusting the associated numeral value.

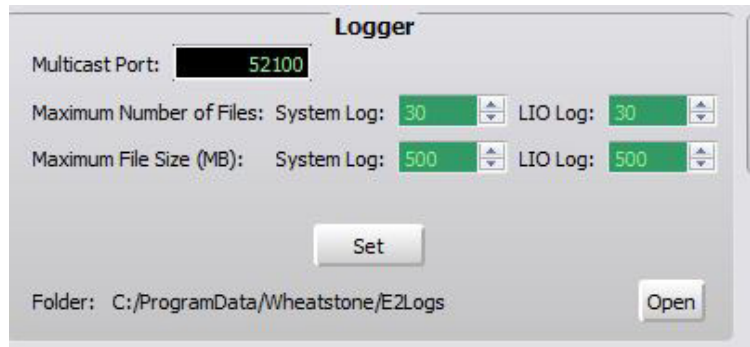

Any changes made in this area require you to click the *Set...* button before they take affect. Once you reach your maximum number of saved files the oldest one will be deleted to maintain the maximum number of files. If the file size reaches it's maximum size then a subsequent file is created with an index number to differentiate between them. The *Folder* path at the bottom is the location of the saved files, along with an *Open* button to open that folder.

Network

If your PC has multiple Network Interface Connections (NIC) then you choose which NIC you want Navigator to use.

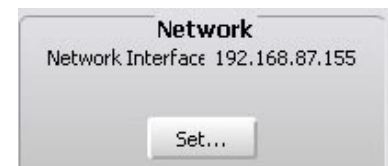
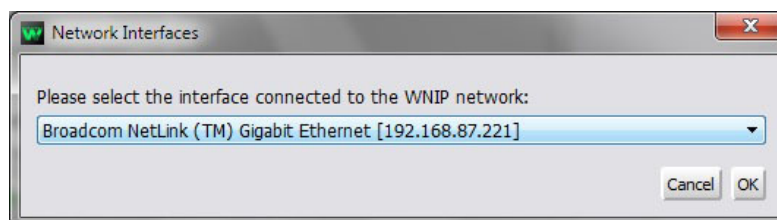

Log Tab

Num	Date/Time	From	Id	Name	Message
88	07/06/2018 13:57:41.200	GUI	1	L8-CB	Received: InputUMix Duck
89	07/06/2018 13:57:41.506	GUI	1	L8-CB	Received: InputUMix Duck
90	07/06/2018 13:57:41.506	GUI	1	L8-CB	Received: InputUMix Duck
91	07/06/2018 13:57:41.506	GUI	1	L8-CB	Received: InputUMix Duck
92	07/06/2018 13:57:41.506	GUI	1	L8-CB	Received: InputUMix Duck
93	07/06/2018 13:57:41.506	GUI	1	L8-CB	Received: InputUMix Duck
94	07/06/2018 13:57:41.506	GUI	1	L8-CB	Received: InputUMix Duck
95	07/06/2018 13:57:41.506	GUI	1	L8-CB	Received: InputUMix Duck
96	07/06/2018 13:57:41.506	GUI	1	L8-CB	Received: InputUMix Duck
97	07/06/2018 13:57:41.506	GUI	1	L8-CB	Received: InputUMix Duck
98	07/06/2018 13:57:41.506	GUI	1	L8-CB	Received: InputUMix Duck
99	07/06/2018 13:57:41.506	GUI	1	L8-CB	Received: InputUMix Duck
100	07/06/2018 13:57:41.506	GUI	1	L8-CB	Received: InputUMix Duck
101	07/06/2018 13:57:41.506	GUI	1	L8-CB	Received: InputUMix Duck
102	07/06/2018 13:57:41.506	GUI	1	L8-CB	Received: InputUMix Duck
103	07/06/2018 13:57:41.506	GUI	1	L8-CB	Received: InputUMix Duck
104	07/06/2018 13:57:41.506	GUI	1	L8-CB	Received: OutputUMix
105	07/06/2018 13:57:41.506	GUI	1	L8-CB	Received: SetupUMix
106	07/06/2018 13:57:41.506	GUI	1	L8-CB	Received: SetupUMix 1.0 -1200 Utility Mixer 2
107	07/06/2018 13:57:41.506	GUI	1	L8-CB	Received: UMix Lio Config
108	07/06/2018 13:57:41.506	GUI	1	L8-CB	Received: Peripheral Info
109	07/06/2018 13:57:41.516	GUI	1	L8-CB	Received: LIO Wires
110	07/06/2018 13:57:41.516	GUI	1	L8-CB	Received: LioWires: begin:true entries: 144
111	07/06/2018 13:57:41.516	GUI	1	L8-CB	Received: ACI Connection Info
112	07/06/2018 13:57:41.526	GUI	1	L8-CB	Received: Proxy Server Info
113	07/06/2018 13:57:41.526	GUI	1	L8-CB	Received: Connected Surfaces
114	07/06/2018 13:57:41.526	GUI	1	L8-CB	Received: ConnectedSurfaces
115	07/06/2018 13:57:41.526	GUI	1	L8-CB	Received: ConnectedSurface: id: 0 ip: 192.168.87.201 name: status: Good
116	07/06/2018 13:57:42.056	GUI	2	LXE Eng	Connected
117	07/06/2018 13:57:42.056	GUI	2	LXE Eng	Received: Version
118	07/06/2018 13:57:42.056	GUI	2	LXE Eng	Received: Net Info
119	07/06/2018 13:57:42.076	GUI	2	LXE Eng	Received: Src Signal List
120	07/06/2018 13:57:42.076	GUI	2	LXE Eng	Received: Src Signal List Message 70 Signals
121	07/06/2018 13:57:42.096	GUI	2	LXE Eng	Received: Dst Signal List
122	07/06/2018 13:57:42.096	GUI	2	LXE Eng	Received: Dst Signal List Message 24 Signals
123	07/06/2018 13:57:42.116	GUI	2	LXE Eng	Received: Dst Signal List
124	07/06/2018 13:57:42.116	GUI	2	LXE Eng	Received: Dst Signal List Message 28 Signals
125	07/06/2018 13:57:42.136	GUI	2	LXE Eng	Received: GPIO Pin Config
126	07/06/2018 13:57:42.136	GUI	2	LXE Eng	Received: GPIO Pin Config
127	07/06/2018 13:57:42.136	GUI	2	LXE Eng	Received: Surface Pin Config
128	07/06/2018 13:57:42.136	GUI	2	LXE Eng	Received: Peripheral Info
129	07/06/2018 13:57:42.146	GUI	2	LXE Eng	Received: LIO Wires
130	07/06/2018 13:57:42.146	GUI	2	LXE Eng	Received: LioWires: begin:true entries: 154
131	07/06/2018 13:57:42.146	GUI	2	LXE Eng	Received: ACI Connection Info
132	07/06/2018 13:57:42.146	GUI	2	LXE Eng	Received: Proxy Server Info
133	07/06/2018 13:57:42.146	GUI	2	LXE Eng	Received: Connected Surfaces
134	07/06/2018 13:57:42.146	GUI	2	LXE Eng	Received: ConnectedSurfaces
135	07/06/2018 13:57:42.156	GUI	2	LXE Eng	Received: ConnectedSurface: id: 0 ip: 192.168.87.93 name: status: Good
136	07/06/2018 13:57:43.846	General	1	L8-CB	Detect master state change for blade 1. Master state is: 1
137	07/06/2018 13:57:43.846	General	1	L8-CB	Setting as system master: id: 1
138	07/06/2018 14:20:54.686	Logger	19	WHEAT-01	[1325489.234] Metronome: Packets = 2, seq # = 12009809, last seq # = 12009807
139	07/06/2018 14:26:11.198	Announcer			Received: Destination Status - Id: 21.0.11 Src: 1.0.0.4 Lock: Yes
140	07/06/2018 14:26:11.288	Announcer			Received: Src Status - Id: 1.0.0.4 Dst: 21.0.11 Alias: No Stream[0]: 239.192.192.7 Offset[0]: 0 Stream[1]: 0.0.0.0 Offset[1]: 0

In a large complex system, it is always a good idea to have some method of viewing the sequence of recent system events. It can be very helpful for reviewing and troubleshooting, especially during system installation and set up when the system is unfamiliar and you're not sure if your LAN set up is correct, etc. The Navigator GUI provides a log window for viewing this information. This log is accumulated until the number of entries matches the setting in the *Max lines* window, after which the earliest entries are discarded as new ones are received.

Using filters you can choose which messages are visible in the log, as well as which columns are displayed.

Because this log is continually being updated, it can be difficult to read. In that case, click on the *Copy All* button which will copy the entire log including filtered entries to the clipboard. You can now paste it into a text editor for easier viewing.

For easier transportation of the saved logs you can click the *Zip...* button and choose the number of days logs to put into one zip file.

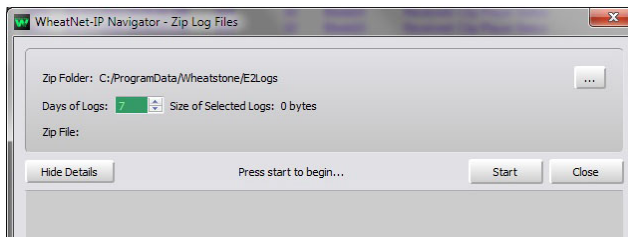
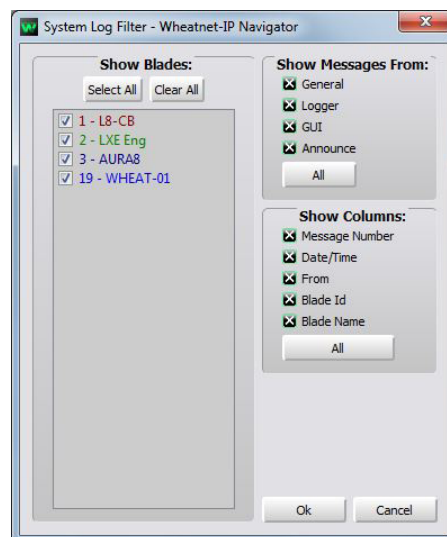

Locator Tab

The screenshot shows the 'Locator' tab in the WheatNet-IP Navigator GUI. The top navigation bar includes 'Crosspoint', 'Salvos/Macros', 'Info', 'LIO Properties', 'Associated Connections', 'Config Manager', 'Version Manager', 'Preferences', 'Log', and 'Locator'. The left sidebar has 'System' and 'Devices' tabs, with 'Devices' selected. Below the sidebar is a 'Filters' panel with expandable sections for Vendor (Wheatstone: 9), Category (WNIP Blade: 5, WNIP Controller: 1, WNIP Surface: 3), Product (Aura8ip: 2, IP-88cb: 1, IP-88e32: 1, LXE: 3, PC Drvr: 1, TS4P: 1), and Component (Module Panel: 2, Play: 4, Surface Host: 1, TS4P: 1, Vorsis Aura8ip: 1). The main table lists 9 devices with the following data:

Vendor	Category	Product	Component	Name	Location	Host Data	IP Address	Subnet Mask	Default Gateway	MAC Addr
Wheatstone	WNIP Blade	PC Drvr	Play	WHEAT-01			192.168.87.19	255.255.255.0	0.0.0.0	D8:EB:97:68:E8:5
Wheatstone	WNIP Surface	LXE	Surface Host	WHEAT-LXE	LAB		192.168.87.93	255.255.255.0	192.168.87.1	00:30:18:CB:EB:8
Wheatstone	WNIP Blade	IP-88e32	Play	LXE Eng			192.168.87.102	255.255.255.0	192.168.87.1	80:E4:DA:00:1E:5
Wheatstone	WNIP Blade	Aura8ip	Play	AURA8			192.168.87.103	255.255.255.0	192.168.87.1	80:E4:DA:00:17:5
Wheatstone	WNIP Blade	IP-88cb	Play	L8-CB			192.168.87.101	255.255.255.0	192.168.87.1	80:E4:DA:00:11:5
Wheatstone	WNIP Blade	Aura8ip	Vorsis Aura8ip	AURA8			192.168.87.103	255.255.255.0	192.168.87.1	80:E4:DA:00:17:5
Wheatstone	WNIP Controller	TS4P	TS4P				192.168.87.220	255.255.255.0	192.168.87.1	80:E4:DA:00:15:5
Wheatstone	WNIP Surface	LXE	Module Panel	WHEAT-LXE	Panel 1	192.168.87.93	169.254.188.32	255.255.0.0	0.0.0.0	80:E4:DA:00:20:5
Wheatstone	WNIP Surface	LXE	Module Panel	WHEAT-LXE	Panel 2	192.168.87.93	169.254.196.32	255.255.0.0	0.0.0.0	80:E4:DA:00:20:5

Below the table are two configuration panels. The 'Set Selected Device Properties' panel has sections for 'Properties' (IP Address, Subnet Mask, Default Gateway, Host Data, Name, Location) and 'Details' (Name, Value, Writable). The 'Set All Selected Devices' panel has 'Host Data' and 'Location' fields with 'Set' buttons. At the bottom are 'Apply', 'Cancel', 'Reboot', and 'Reboot Selected Devices' buttons.

The Locator tab allows the user to ping the network to get a list of devices that are attached to the network. Additionally, filters can be added to pair down the list by device type, in addition to the ability to sort any of the fields in the results.

Navigator GUI Devices Windows in Detail

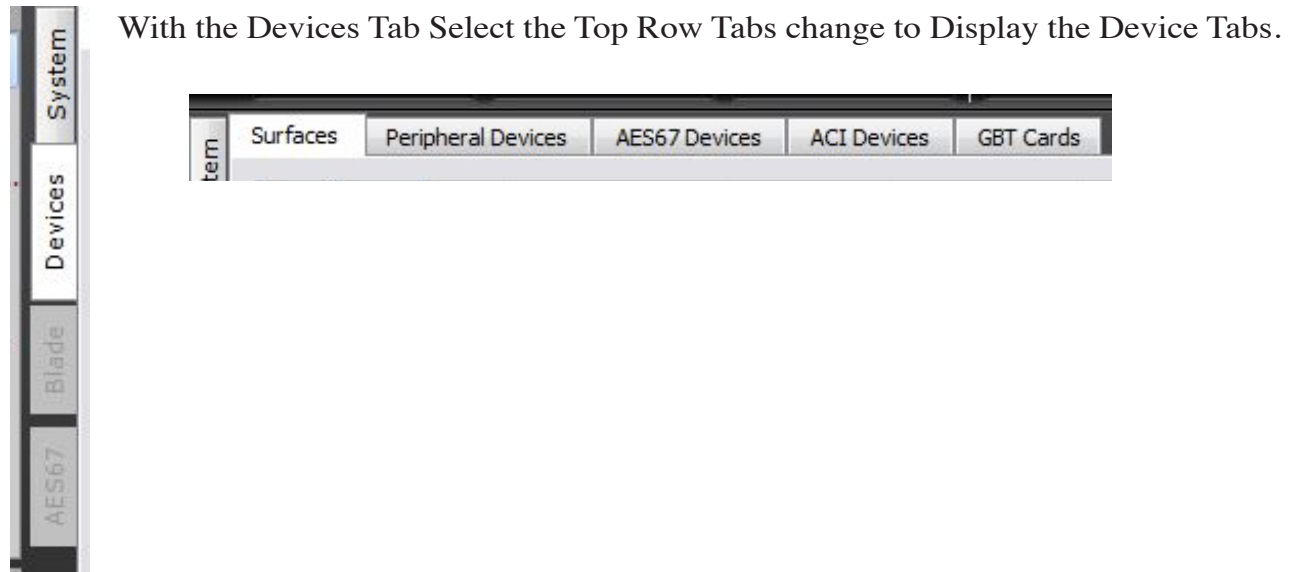

Surfaces Tab

Launch	Status	Surface	Type	IP Address	Host Blade	Id	SW Version	HW Version	Num Spares	Num Faders	Error Message
X	●		L8 Mixer	192.168.87.201	L8-CB		1.4.14	1.4.14	8	8	
X	●		LXE Mixer	192.168.87.93	LXE Eng		1.23	1.23	14	32	

Blades with unconnected surfaces:

Host Blade	Type	Id	IP Address

System: ID: 0
Masters: Route Master: 1 - L8-CB, Clock Master: 3 - AURAB
Blades: Total: 4
No Errors: System in good health

The Surfaces Tab when selected displays the currently connected WNIP Surfaces in the system. Information such as software version, number of faders and spare buttons are also displayed.

Peripheral Devices Tab

There are a number of products in the WheatNet-IP system that must be added to the System *Peripheral Devices* tab to utilize their complete set of features. Such devices include certain Control Surfaces, Audio Processors, and some other control devices and system components.

You will need to know the IP address of the device being added, so you will want to find that out before you start.

With the Navigator GUI and with the System selected in the System pane you will see something like this:



Now select the *Peripheral Devices* tab.

Launch	Status	Device	IP Address	Port	Host Blade	Id	Vendor	Product	Add...
Launch	●	L8	192.168.87.201	60021	L8-CB	1	Wheatstone	L8	Add...
Launch	●	TS4H	192.168.87.220	60021	LXE Eng	1	Wheatstone	TS4P	Edit...
X	●	Meters	192.168.87.19	60021	AURA8	1	Wheatstone	MeterMonitor	Remove

Click the *Add* button to bring up the *Add Peripheral Device* dialog:

Type in a convenient *Name* and insert the *IP Address* of the device being added. Leave the *TCP Port* at the default setting of **60021**. From the *Host BLADE3* drop down select the *BLADE3* that you want to associate the 3rd Party device with. Click *Ok*.

Add Peripheral Device

Peripheral Device:

Name:

IP Address:

TCP Port:

Host Blade:

Ok Cancel

This completes the process of adding the device to the *Peripheral Devices* tab. The added device should show up in the *System* pane under the *BLADE3* you added it to. If it does not show up, or if it shows up but has a yellow question mark on it, then there is either a network issue that needs attention, or the device is not connected to the network at all, or one or more steps have been omitted or done incorrectly in the configuration process.

ACI Devices Tab

Launch	Status	Blade	Id	IP Address	Subscriptions	Vendor	Product	Name	MAC Address	SW Version	FW Version	SVM Version	Text
0	X	1	0	192.168.87.93	10								IP Screen Engine @ lxe
1	Launch	1	1	192.168.87.70	11	Wheatstone	GP-16P	gp1	40:D8:55:1D:7D:C0	3.6.5	0A.05	2.7.0	IP Screen Engine @ lxe
2	X	2	0	192.168.87.93	3								IP Screen Engine @ lxe
3	Launch	2	1	192.168.87.220	2	Wheatstone	TS4P	TS4P	80:E4:DA:00:15:EA	1.4.5	0A.15		
4	X	3	0	192.168.87.19	2								MeterApp

The ACI (Automation Control Interface) Devices tab is a convenient place that lists all of the various peripheral devices and applications that have been defined for your system so you can see them all (and their IP Addresses and Host BLADE 3 IDs, etc.) at a glance.

AES67 Devices Tab

The BLADE 3s support AES67 compliant devices using an IEEE1588 PTP grandmaster clock for synchronizing to and ingesting/streaming AES67 compliant packets. Refer to the “WheatNet-IP and AES 67” Addendum at the beginning of this manual for more information.

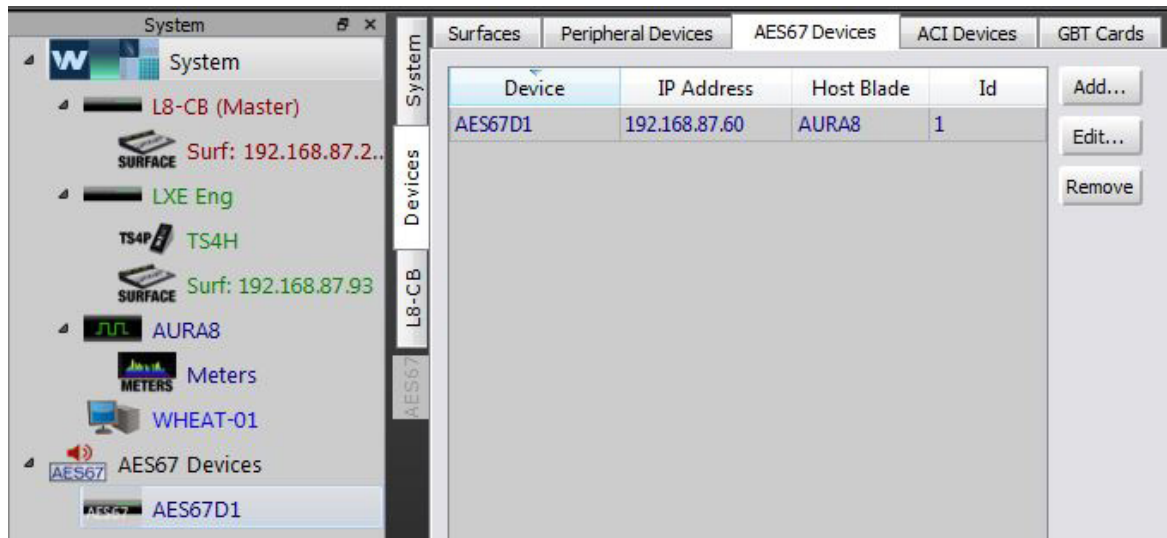

Devices

Press *Add...* button to add an AES67 device to the system. Enter the device name and IP address, specify a Host BLADE 3.

Device Info

For details on further setup of AES67 Devices, please refer to the “WheatNet-IP and AES 67” Appendix 11 of this manual.

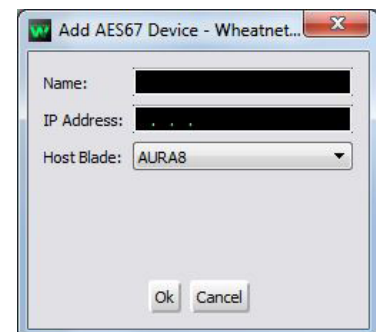

GBT Cards Tab

This tab displays information about connected GBT cards connected to the WNIP System. GBT cards are special cards placed in Gibraltar Cages to interface it to a BLADE 3 System.

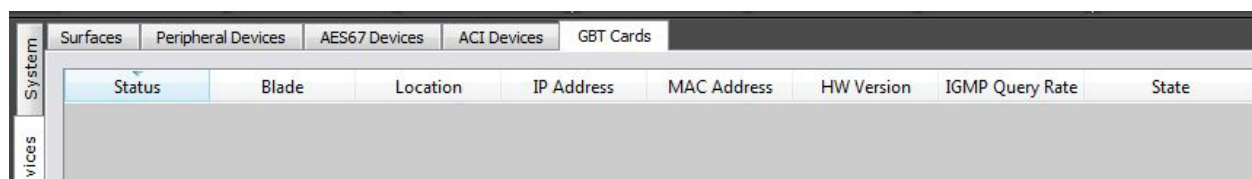

Navigator GUI Blade Windows in Detail

Earlier, when we were looking at the System pane, we noted that we could see an icon for each BLADE3 connected in the system. If we left click on one of these icons to select it, the GUI switches to the BLADE view and a whole new set of tabs appear in the main window. These tabs are for functions and settings not at the system level, but localized to the individual BLADE3s. If you click on several different BLADE3 icons you will see the same set of tabs appearing over and over, but the detailed information within each tab changes from BLADE3 to BLADE3. So the process becomes one of clicking on a BLADE3 icon, verifying or modifying the settings for that BLADE3, clicking on the next BLADE3 icon, verifying its settings, and so forth until you've looked at every BLADE3.

The screenshot displays the Wheatnet-IP Navigator GUI in the Blade view for L8-CB. The interface is organized into several key sections:

- System Tree (Left Sidebar):** Shows a hierarchy starting with 'System', followed by 'L8-CB (Master)' and 'AES67 Devices'. Under 'L8-CB', there are icons for 'SURFACE' (Surf: 192.168.87.2...), 'LXE Eng', 'TS4P TS4H', 'SURFACE' (Surf: 192.168.87.93), 'JUL AURAB', 'Meters', 'WHEAT-01', and 'AES67 Devices' (AES67D1).
- Alarms Panel:** Displays an active alarm: 'Silence Detect - Failed Id: 3.0.0.8', 'Name: BL003D08', 'Location: Blade03', 'Width: Stereo'.
- Blade Details Panel:** Provides information for the selected blade:
 - Name:** L8-CB
 - ID:** 1
 - Type:** IP-88cb
 - Status:** Connected
 - MAC Address:** 80:E4:D4:00:11:46
 - Surface Info:** Surface ID: 0, IP Address: 192.168.87.201, Type: L8 Mixer, Software Ver: 1.4.14, Hardware Ver: 1.4.14, Num Spares: 8, Num Faders: 8.
 - Peripheral Device Info:** Vendor: Wheatstone, Product: L8, Name: L8, Device ID: 1, IP Address: 192.168.87.201, Port: 60021.
- Main Panel Tabs:**
 - Source Signals:** A table listing signals and their locations:

Name	Location
MIC2	L8-CB
MIC1	L8-CB
MAC/PC	Blade01
HDRCVR	Blade01
BL001S05	Blade01
BL001S06	Blade01
BL001S07	Blade01
BL001S08	Blade01
EVENT1	Blade01
SATBREAK	Blade01
WOSalv1	Blade01
WODlyIn	Blade01
WOSalv2	Blade01
BL01UMXA	Blade01
BL01UMXB	Blade01
 - Free Resources:** Lists available audio and LIO resources, including 'Audio In Surround 5.1 (0)', 'Audio In Stereo (1)', 'Blade LIOs (10)', and 'Functional LIOs (4)'.
- Meters Section:** Features eight dBFS level meters and LVL/BAL controls for inputs: MIC1, MIC2, MAC/PC, HDRCVR, BL001S05, BL001S06, BL001S07, and BL001S08. Each input has a level meter and a balance control.
- Status Bar:** Shows system health: 'No Errors: System in good health'. A footer line provides system metrics: 'Jul 06 2018, 14:54:45 - temperature 46.0 deg C - cpu 1.8% - uptime 15 days, 08:48:10'.

Sources Tab



The first tab is the BLADE 3 “Sources” tab. It is used for viewing and modifying settings for the local audio inputs in the BLADE 3. The Sources window has four main parts. Along the bottom of the window is an array of 16 bargraph meters and individual level and balance controls for each source (Mono sources do not have balance controls). These meters and controls are used to monitor the level and set gain on the 16 inputs (or eight stereo pairs, etc.) coming into the BLADE 3. In the upper left area of the main window is a section labeled “Source Signals:” and to the right is the “Free Resources:” section. The “Source Signals:” section is where the eight character input signal name and eight character input location names can be seen and modified from their defaults. The “Free Resources:” section is where the input signal characteristics (mono, stereo, logic, etc.) can be seen. The “User Info” section will display any entries into the selected signals User Info tab. To add info to a signal click on the signal name to select it, then click the *Edit...* button and the User Info tab. Now simply add any notes here about the signal you want displayed.

Source Signals

In this section you can see two columns; the first column, labeled “Name” is the source name and the second matching column, labeled “Location,” is the source location. Depending on whether the BLADE 3 has been designated as a stereo or mono BLADE 3 at initial set up, there will be eight or 16 names in the columns. (If the BLADE 3 was originally set up as a custom BLADE 3, there will actually be no source or location names showing until you first define the mono and stereo signals you want – more on that later). If the BLADE 3 is an engine BLADE 3, there will be names for every available control surface input and monitor channel (depending on the size of the associated control surface this can be as many as 32 or more).

Assuming you are looking at BLADE #1 and you've chosen the stereo signal template, the Source Signals section will look as shown here:

The first signal in the list (representing input #1) is named "BL01S01" and its location is named "Blade01." These are the system default names and they can be simply decoded. The "BL01" part of the name is just shorthand for "BLADE 1," and the "S01" is shorthand for "Source 1." Thus the auto generated system name means "the first input in BLADE 1." Likewise, "BL01S02" means "the second input in BLADE 1," and "BL23S07" means "the seventh input in BLADE 23." It's not exactly Rocket Science and, in fact, you can just leave things as they are and go with the system default names if you like. But you can do better. If you double click on a signal name, the name becomes highlighted and you can retype it to be anything you like. "BL01S01" becomes "JAY," or "PHIL," or "GUEST1," or "GUEST2" or CALLER1 – you get the idea. As soon as you type a new name for the signal, it appears everywhere in the system under this new name. In other BLADE 3s, on the crosspoint grid, on control surface displays, everywhere.

Likewise, the "Location" column has default location names which are even more easily decoded; "Blade01" obviously means "BLADE 1." You can leave these as they are because that pretty much tells you the location of the signal, but if you want, you can change the location to "WXYY" or "rackroom" or whatever suits your fancy. Edit the Location just as you did the Name, by double clicking on it.

Source Signals:	
Name	Location
BL01S01	Blade01
BL01S02	Blade01
BL01S03	Blade01
BL01S04	Blade01
BL01S05	Blade01
BL01S06	Blade01
BL01S07	Blade01
BL01S08	Blade01

Source Signals:	
Name	Location
JAY	WXYY
PHIL	WXYY
GUEST 1	WXYY
GUEST 2	WXYY
CALLER 1	WXYY
BL01S06	Blade01
BL01S07	Blade01
BL01S08	Blade01

Free Resources

Resources to a BLADE 3 mean audio and logic signals. This section of the Sources window shows the remaining available resources within the BLADE 3. The first three line entries in this section indicate the number of surround 5.1, stereo, and mono signals sources, respectively, that have not yet been allocated to the system, and are hence available for allocation. Remember, each BLADE 3 has a maximum total of 16 mono audio channels plus 12 logic ports available. If you have used a standard mono or stereo signal template when you first initiated the BLADE 3, then all of the signals will have been allocated automatically by the Startup Wizard to match the template, and the number available will show as zero. This is one of the special features of the WheatNet-IP system; it can take care of all of this signal allocating and defining automatically, saving you a lot of work.

If, however, you chose the Custom template, no signals will have been allocated, and all will show as available in the resources list. As you define a new signal, the resources available will decrease. Thus

Free Resources	
Audio In Surround 5.1 (0)	
Audio In Stereo (1)	
Input 2 LT - Input 2 RT	
Audio In Mono (2)	
Input 2 LT	
Input 2 RT	
Blade LIOs (10)	
LIO 1 Pin 2	
LIO 1 Pin 3	
LIO 1 Pin 5	
LIO 1 Pin 6	
LIO 1 Pin 7	
LIO 2 Pin 3	
LIO 2 Pin 4	
LIO 2 Pin 5	
LIO 2 Pin 6	
LIO 2 Pin 7	
Functional LIOs (4)	
AES Input Error CH5	

you can tell by looking at the resources list what additional signals you could define for this particular BLADE 3.

Add Button

Defining a new signal is easy. Click the *Add* button and the “Source Signal Wizard - Add Signal” screen pops up. On the Type Info tab enter the Name, and optionally the Location. Select the Signal Type and accept the Packet Type as automatically selected. Next, switch to the Wire Info tab. Highlight the desired wire number (you must pick one that is not already assigned), then click *Finish*. The new signal name will now appear throughout the system.

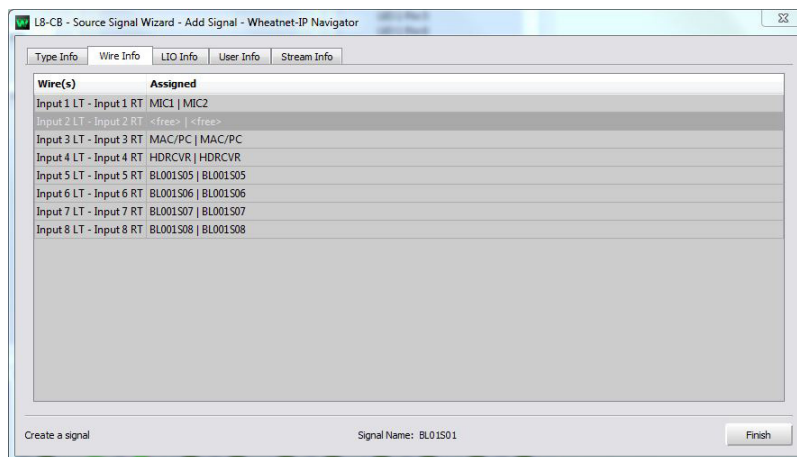
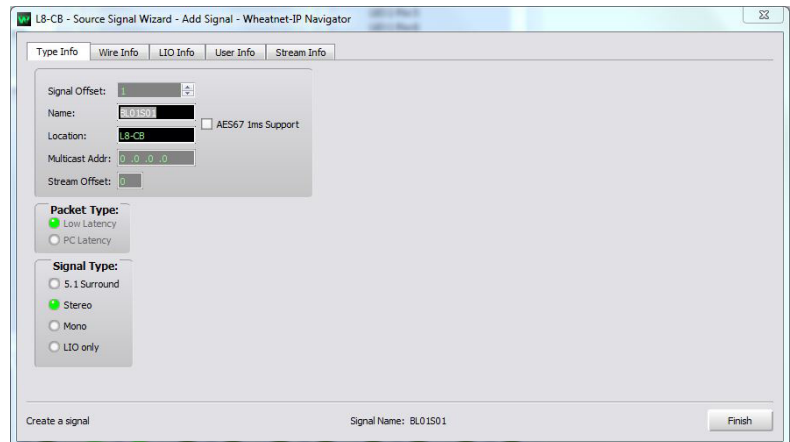

The same is true for the logic ports. The default configuration makes no automatic assignment of logic ports, so all 12 are initially available and show as LIOs. As you allocate logic ports for functions, the resources decrease correspondingly. The “available resources” list, then, allows you to see at a glance how many ports you’ve used.

Add Alias Button

The BLADE 3s’ Alias feature allows the same source to be identified by different names. The Sources and Destinations windows now have an “Add Alias...” button.

The alias is a special class of signals. It may be that the need for an alias arises when you have a signal that you sometimes want to treat as a stereo signal and sometimes want to treat as a pair of mono signals.

As an example, let’s say you have a BLADE 3 analog output wired to the stereo input of a computer sound card. Sometimes you are recording the air signal from a stereo program bus, but other times you want to feed the left side of the sound card with a mono signal such as a talent mic and the right side with a mix-minus bus like you might get

from a caller. With the output defined as a stereo signal, you can't feed it from two mono sources. But with the output defined as two mono signals, you can't feed it the left and right sides of a stereo source.

Enter the alias. Let's say, to use actual numbers, that you have defined a stereo destination named **Comp1** that maps to circuits 1 and 2 of the analog output. The circuit 1 and 2 outputs are wired to a computer sound card stereo input. In addition you define a mono destination **Comp1LT** that maps only to circuit 1, and a second mono destination **Comp1RT** that maps only to circuit 2.

Now if you make a crosspoint between a stereo source and **Comp1** (the original stereo destination) the left side of the stereo source will be routed to circuit 1 of the output and the right side of the stereo source will be routed to circuit 2 of the output. On the other hand, if you make a crosspoint between one mono source and **Comp1LT**, and a second mono source and **Comp1RT**, then the first source will show up on circuit 1 and the second source will show up on circuit 2.

Another use of aliases would be to allow a signal to have one name for use by one operator (or talent) and a different name for use by another operator. For example, let's say a mic source has been named "Joe" because it is used by the host Joe on a morning talk show. But maybe the the same mic is used later in the day by Fred on his show. Now that mic can appear as both "Joe" and "Fred" through the use of aliases.

To add an Alias first select the signal you want to copy by clicking on the signal name. Now click the *Add Alias* button and the "Source Signal Wizard - Add Alias Signal" screen pops up. On the Type Info tab enter the Name, and optionally the Location. Select the Signal Type and accept the Packet Type as automatically selected. Next, if you are creating a mono alias from a stereo signal, select the Wire Info tab and highlight the desired wire number. Then click *Finish*.

Base Signal Info—This section will show you the Id, Name, and Location of the signal you are creating alias from.

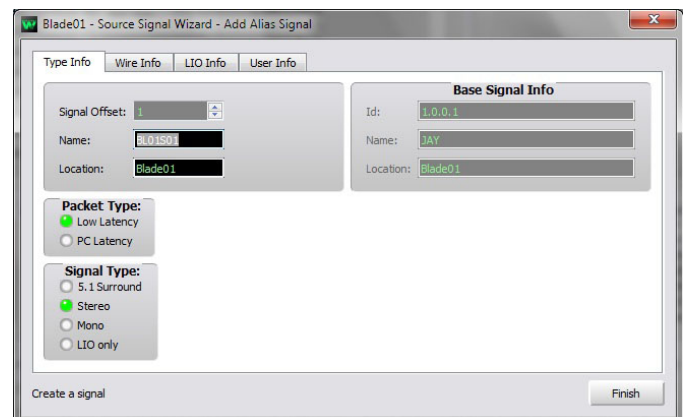

Edit Button

OK, so how do you modify the logic resources? Click on a signal name or location in the Source Signals: area, then click on the *Edit* button. This opens a "Source Signal Wizard - Edit Signal" window where you can redefine the audio signal type or, in this case, add or change logic signals associated with the audio. Use of this form has already been covered in the Source Details Menu section of this chapter under the topic "Modify Signal", page 5-29. The "LIO Info" tab of this form is where you define the logic associated with the audio signal.

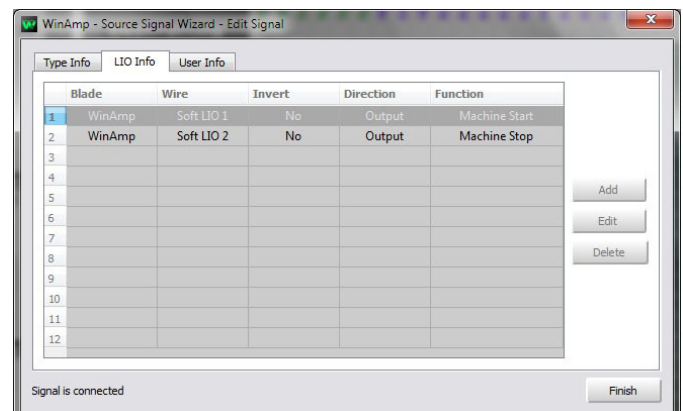

Delete Button

The *Delete* button completes the signal modification tools. Highlight a signal and choose “Delete” and the “Delete Signal” window with a question “Are you sure?” opens. If you click on *Yes*, then the selected signal is removed from the system, adding those resources back to the Free Resources: list.

It all sounds more complicated than it is, but most folks will just use the automatic system defaults and not bother with any of this initially, at least until they need to define some logic signals. Don’t be afraid to experiment with defining signals. You can always edit back any changes you make, and if you really get things out of whack, you can just rerun the System Startup Wizard for the BLADE 3 and start over.

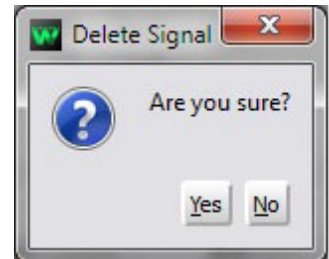

Meters

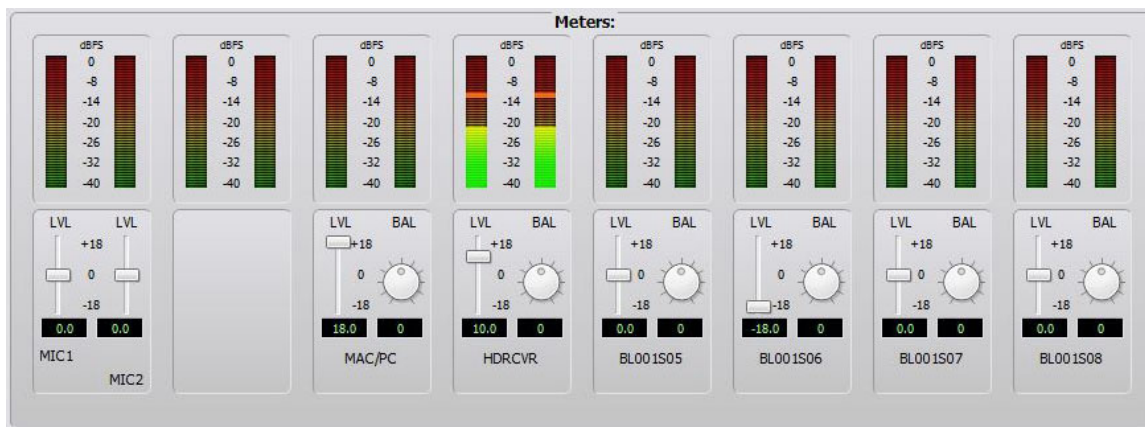

The bottom portion of the Sources tab window, as mentioned before, shows the input channel meters and gain settings. The 16 individual bargraph meters show audio levels for the individual channels color coded over a 40dB range, with the highest level being “+20” VU, corresponding to +24dBu, 0dBFS, and the onset of clipping. These meters show the actual input signal level as modified by the input gain setting. The bouncing bar at the top shows the peak audio level while the solid column shows the short term average audio level using VU time constants.

Below the bargraph meters are individual slider controls for adjusting each channel’s gain or loss over a range of +/- 18dB. The slider handle, or knob, moves to indicate a relative gain setting as you drag it with your mouse, and the text box below the slider updates with the specific gain value. If you prefer, you can drag your cursor over the number in the text box to highlight it and type in the gain value you want. The gain adjustment is made in real time and will reflect instantly on the bargraph meters. The system rounds off gain settings to the nearest 1/10th dB.

If the signal is defined as stereo a balance control will be displayed to the right of the level control. This control allows you to adjust the balance of the left and right stereo signal. The adjustments can be made by left clicking and holding the control while moving the cursor in a circular motion. If you prefer, the arrow keys can also be used to make this adjustment. Like the level control, you can highlight the number in the text box and set the balance level with “0” being center. The balance adjustments are also made in real time and will reflect instantly on the bargraph meters.

Please note that any gain modifications you make to a source signal will affect the level of that signal everywhere in the system it appears. If you are making a gain adjustment to compensate for one particular destination only, it might be better to make a destination gain adjustment (more on this in the next section) and leave the source gain alone for correct use in other parts of the system. Source gain adjustments are best used for input signals known to be too hot or too low, to bring them to the nominal system signal level of 0VU, +4dBu, -20dBFS.

Destinations Tab

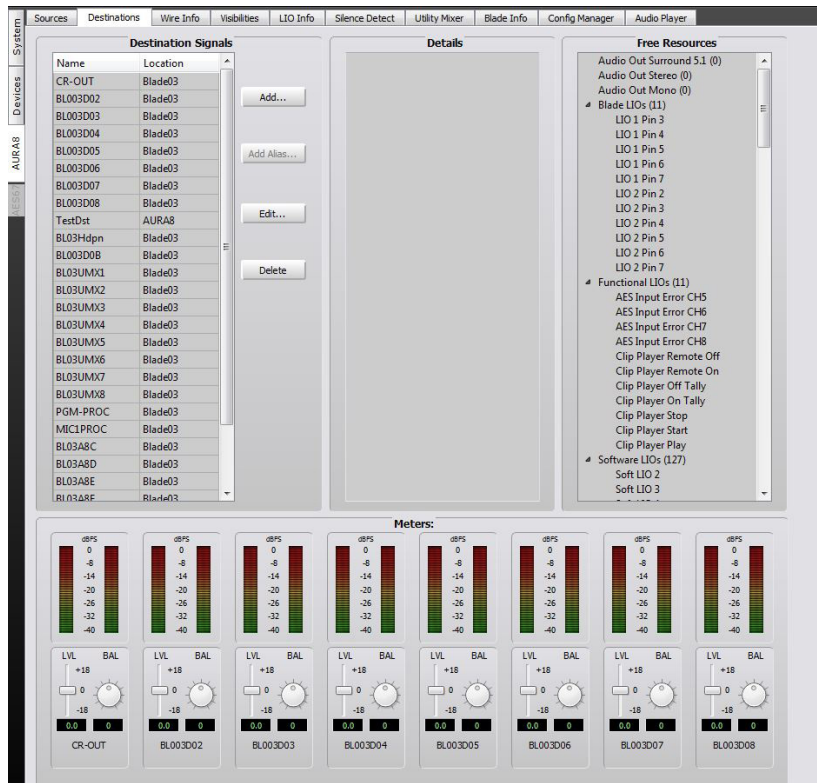

The second tab is the BLADE 3 “Destinations” tab. It is used for viewing and modifying settings for the local audio outputs from the BLADE 3. The Destinations window has four main parts. Along the bottom of the window is an array of 16 bargraph meters and individual level and balance controls for each source (Mono sources do not have balance controls). These meters and controls are used to monitor the level and set gain on the 16 outputs (or eight stereo pairs, etc.) going out of the BLADE 3. In the upper left area of the main window is a section labeled “Destination Signals:”, in and to the right is the “Free Resources:” section. The Destination Signals: section is where the eight character output signal name and eight character output location names can be seen and modified from their defaults. The Free Resources: section is where the output signal characteristics (mono, stereo, logic, etc.) can be seen. The “User Info” section will display any entries into the selected signals User Info tab. To add info to a signal click on the signal name to select it, then click the *Edit...* button and the User Info tab. Now simply add any notes here about the signal you want displayed.

Destination Signals

In this section you can see two columns; the first column, labeled “Name” is the destination name and the second matching column, labeled “Location,” is the destination location. Depending on whether the BLADE 3 has been designated as a stereo or mono BLADE 3 at initial set up, there will be eight or 16 names in the columns. (If the BLADE 3 was originally set up as a custom BLADE 3, there will actually be no destination or location names showing until you first define the mono and stereo signals you want — more on that later).

Assuming you are looking at BLADE 1 and you've chosen the stereo signal template, the Destination Signals section will look as shown here:

The first signal in the list (representing output #1) is named "BL01D01" and its location is named "Blade01." These are the system default names and they can be simply decoded. The "BL01" part of the name is just shorthand for "BLADE 1," and the "D01" is shorthand for "Destination 1." Thus the auto generated system name means "the first output in BLADE 1." Likewise, "BL01D02" means "the second output in BLADE 1," and "BL23D07" means "the seventh output in BLADE 23." You can just leave things as they are and go with the system default names if you like. But you can do better. If you double click on a signal name, the name becomes highlighted and you can retype it to be anything you like. "BL01D01" becomes "Speaker," or "TALLY," or "CB01HDPN," or "CB01CUE" - you get the idea. As soon as you type a new name for the signal, it appears everywhere in the system under this new name. In other BLADE 3s, on the crosspoint grid, on control surface displays, everywhere.

Likewise, the "Location" column has default location names which are even more easily decoded; "Blade01" obviously means "BLADE 1." You can leave these as they are because that pretty much tells you the location of the signal, but if you want, you can change the location to "WXYZ Air" or "Rackroom" or whatever suites your fancy. Edit the Location just as you did the Name, by double clicking on it.

Free Resources

Resources to a BLADE 3 mean audio and logic signals. This section of the Destination window shows the remaining available resources within the BLADE 3. The first three line entries in this section indicate the number of surround 5.1, stereo, and mono signal destinations, respectively, that have not yet been allocated to the system, and are hence available for allocation. Remember, each BLADE 3 has a maximum total of 16 mono audio channels plus 12 logic ports available. If you have used a standard mono or stereo signal template when you first initiated the BLADE 3, then all of the signals will have been allocated automatically by the Startup Wizard to match the template, and the number available will show as zero. This is one of the special features of the WheatNet-IP system; it can take care of all of this signal allocating and defining automatically, saving you a lot of work.

If, however, you chose the Custom template, no signals will have been allocated, and all will show as available in the resources list. As you define a new signal, the resources available will decrease. Thus you can tell by looking at the resources list what additional signals you could define for this particular BLADE 3.

Destination Signals:	
Name	Location
BL01D01	Blade01
BL01D02	Blade01
BL01D03	Blade01
BL01D04	Blade01
BL01D05	Blade01
BL01D06	Blade01
BL01D07	Blade01
BL01D08	Blade01
BL01Hdpn	Blade01
BL01UMX1	Blade01
BL01UMX2	Blade01

Destination Signals:	
Name	Location
Speakers	Rackroom
TALLY	Rackroom
CB01HDPN	Rackroom
CB01CUE	Rackroom
BL01D05	Blade01
BL01D06	Blade01
BL01D07	Blade01
BL01D08	Blade01
BL01Hdpn	Blade01
BL01UMX1	Blade01
BL01UMX2	Blade01

Free Resources	
Audio Out Surround 5.1 (0)	
Audio Out Stereo (0)	
Audio Out Mono (0)	
Blade LIOs (11)	
LIO 1 Pin 3	
LIO 1 Pin 4	
LIO 1 Pin 5	
LIO 1 Pin 6	
LIO 1 Pin 7	
LIO 2 Pin 2	
LIO 2 Pin 3	
LIO 2 Pin 4	
LIO 2 Pin 5	
LIO 2 Pin 6	
LIO 2 Pin 7	
Functional LIOs (11)	
AES Input Error CH5	
AES Input Error CH6	
AES Input Error CH7	
AES Input Error CH8	
Clip Player Remote Off	
Clip Player Remote On	
Clip Player Off Tally	
Clip Player On Tally	
Clip Player Stop	
Clip Player Start	
Clip Player Play	
Software LIOs (127)	
Soft LIO 2	
Soft LIO 3	

Add Button

Defining a new signal is easy. Click the *Add* button and the “Destination Signal Wizard - Add Signal” screen pops up. On the Type Info tab enter the Name, and optionally the Location. Select the Signal Type and accept the Packet Type as automatically selected. Next, switch to the Wire Info tab. Highlight the desired wire number (you must pick one that is not already assigned), then click *Finish*. The new signal name will now appear throughout the system.

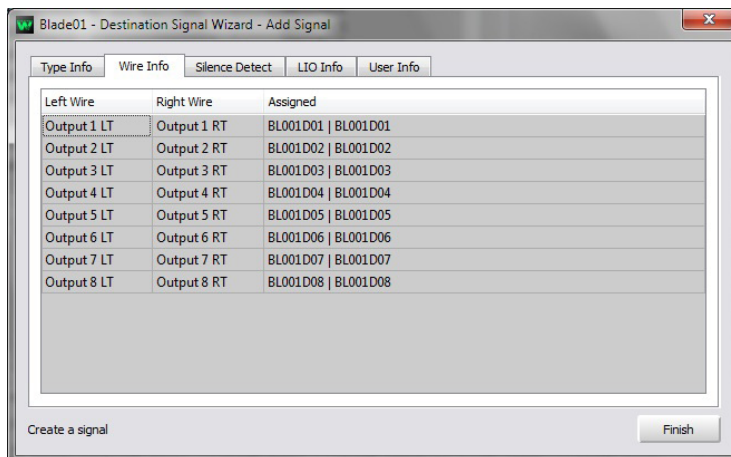
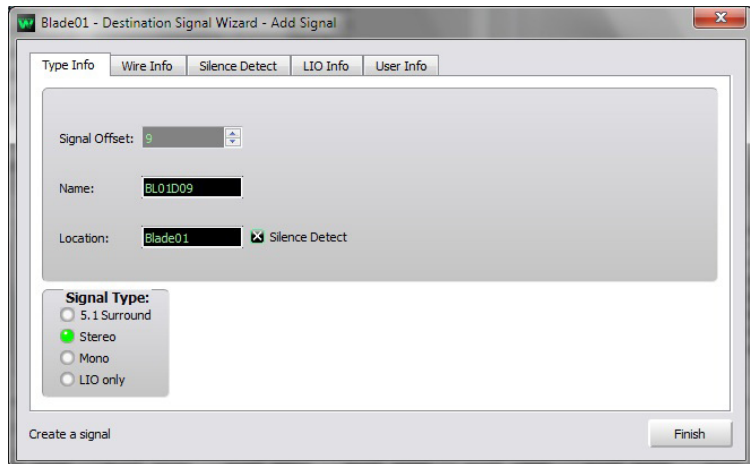

The same is true for the logic ports. The default configuration makes no automatic assignment of logic ports, so all 12 are initially available and show as LIOs. As you allocate logic ports for functions, the resources decrease correspondingly. The “Free Resources” list, then, allows you to see at a glance how many ports you’ve used.

The Silence Detect tab opens a window where you defined parameters for detecting silence of audio signal. Use of this form has already been covered in the Destination Details Menu section of this chapter under the topic “Modify Signal”, page 5-25.

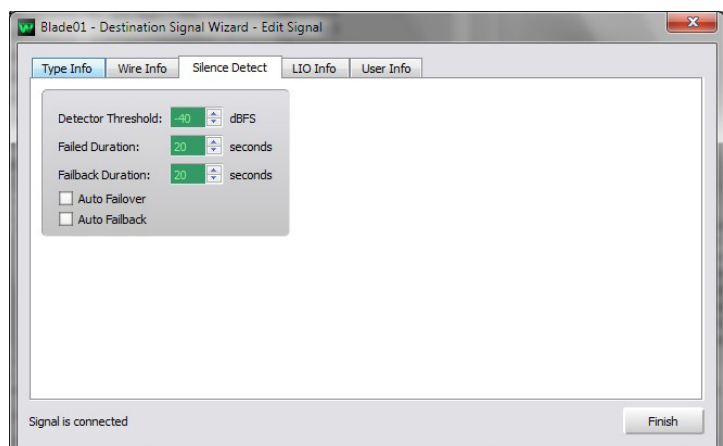

Add Alias Button

To Add Alias to your system follow the same steps described above.

See page 5-56 for the Alias feature description.

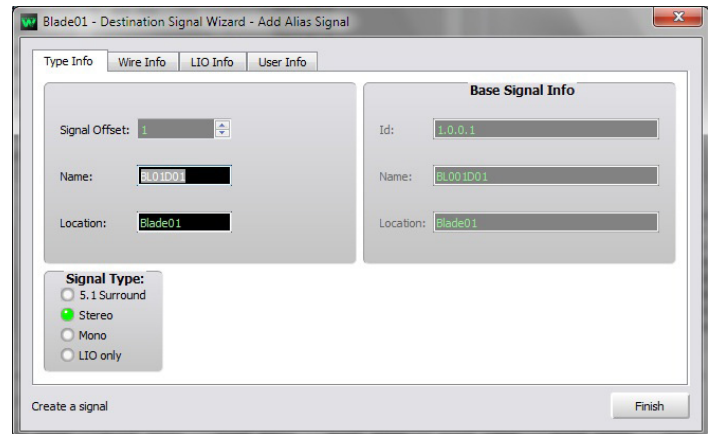

Edit Button

OK, so how do you modify the logic resources? Click on a signal name or location in the Destination Signals: area, then click on the *Edit* button. This opens a “Destination Signal Wizard - Edit Signal” window where you can redefine the audio signal type or, in this case, add or change logic signals associated with the audio. Use of this form has already been covered in the Destination Details Menu section of this chapter under the topic “Modify Signal.” The “LIO Info” tab of this form is where you define the logic associated with the audio signal.

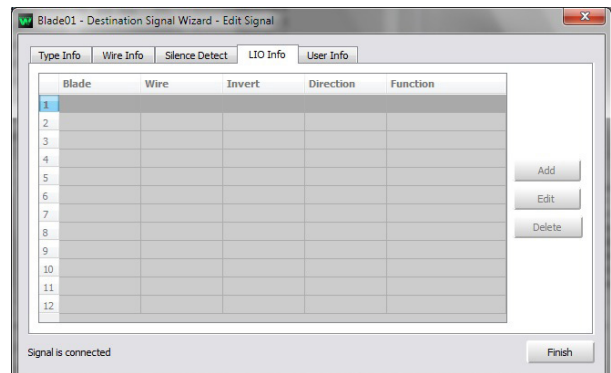

Delete Button

The *Delete* button completes the signal modification tools. Highlight a signal and choose “Delete” and the “Delete Signal” window with a question “Are you sure?” opens. If you click on *Yes*, then the selected signal is removed from the system, adding those resources back to the Free Resources: list.

Most folks will just use the automatic system defaults and not bother with any of this initially, at least until they need to define some logic signals. Don’t be afraid to experiment with defining signals. You can always edit back any changes you make, and if you really get things out of whack, you can just rerun the System Startup Wizard for the BLADE3 and start over.

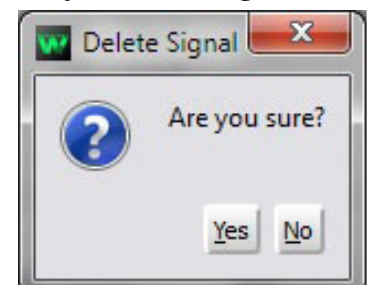

Meters

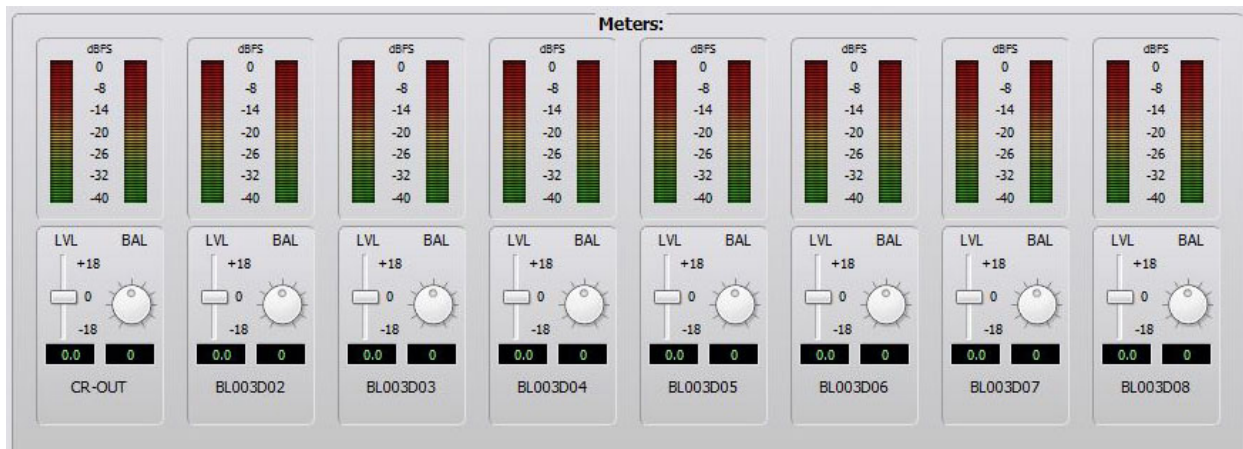

The bottom portion of the “Destinations” tab window, as mentioned before, shows the output channel meters and gain settings. The 16 individual bargraph meters show audio levels for the individual channels color coded over a 40dB range, with the highest level being “+20” VU, corresponding to +24dBu, 0dBFS, and the onset of clipping. These meters show the actual output signal level as modified by the output gain setting.

Below the bargraph meters are shown individual slider controls for adjusting each channel’s gain or loss over a range of +/-18dB. The slider handle, or knob, moves to indicate a relative gain setting as you drag it with your mouse, and the text box below the slider updates with the specific gain value. If you prefer, you can drag your cursor over the number in the text box to highlight it and type in the gain value you want. The gain adjustment is made in real time and will reflect instantly on the bargraph meters. The system rounds off gain settings to the nearest 1/10th dB.

If the signal is defined as stereo a balance control will be displayed to the right of the level control. This control allows you to adjust the balance of the left and right stereo signal. The adjustments can be made by left clicking and holding the control while moving the cursor in a circular motion. If you prefer, the arrow keys can also be used to make this adjustment. Like the level control, you can highlight the number in the text box and set the balance level with “0” being center. The balance adjustments are also made in real time and will reflect instantly on the bargraph meters.

Please note that any gain modifications you make to a destination signal will affect the level of that output for all sources feeding it. If you are making a gain adjustment to compensate for a systematic gain problem, it might be better to make a source gain adjustment, and leave the destination gain alone. Destination gain adjustments are best used for output signals known to be too low or too hot, such as those feeding headphones or amplified speakers with no gain control of their own, to bring them to the correct listening level.

Wire Info Tab

Sources:							Destinations:						
Card	Circuit	Wire	Sig Id	Width	Assigned		Card	Circuit	Wire	Sig Id	Width	Assigned	
0	0	Input 1 LT	1.0.0.1	Mono	MIC1		0	0	HDPN LT	1.0.4.0	Stereo	CB01HDPN	
0	1	Input 1 RT	1.0.0.0	Mono	MIC2		0	1	HDPN RT	1.0.4.0	Stereo	CB01HDPN	
0	2	Input 2 LT			<free>		0	2	CUE LT	1.0.4.1	Stereo	CB01CUE	
0	3	Input 2 RT			<free>		0	3	CUE RT	1.0.4.1	Stereo	CB01CUE	
0	4	Input 3 LT	1.0.0.3	Stereo	MAC/PC		0	4	Studio LT	1.0.4.2	Stereo	CB01STU	
0	5	Input 3 RT	1.0.0.3	Stereo	MAC/PC		0	5	Studio RT	1.0.4.2	Stereo	CB01STU	
0	6	Input 4 LT	1.0.0.4	Stereo	HDRCVR		0	6	CR LT	1.0.4.3	Stereo	CB01CR	
0	7	Input 4 RT	1.0.0.4	Stereo	HDRCVR		0	7	CR RT	1.0.4.3	Stereo	CB01CR	
0	8	Input 5 LT	1.0.0.5	Stereo	BL001S05		0	8	Program A LT	1.0.4.4	Stereo	CB01PGMA	
0	9	Input 5 RT	1.0.0.5	Stereo	BL001S05		0	9	Program A RT	1.0.4.4	Stereo	CB01PGMA	
0	10	Input 6 LT	1.0.0.6	Stereo	BL001S06		0	10	Program B LT	1.0.4.5	Stereo	CB01PGMB	
0	11	Input 6 RT	1.0.0.6	Stereo	BL001S06		0	11	Program B RT	1.0.4.5	Stereo	CB01PGMB	
0	12	Input 7 LT	1.0.0.7	Stereo	BL001S07		0	12	Program C LT	1.0.4.6	Stereo	CB01PGMC	
0	13	Input 7 RT	1.0.0.7	Stereo	BL001S07		0	13	Program C RT	1.0.4.6	Stereo	CB01PGMC	
0	14	Input 8 LT	1.0.0.8	Stereo	BL001S08		0	14	Program D LT	1.0.4.7	Stereo	CB01PGMD	
0	15	Input 8 RT	1.0.0.8	Stereo	BL001S08		0	15	Program D RT	1.0.4.7	Stereo	CB01PGMD	
0	3328	UMix-1 Out A LT	1.0.3.0	Stereo	BL01UMXA		0	2048	HDPN LT	1.0.1.0	Stereo	BL01Hdpn	
0	3329	UMix-1 Out A RT	1.0.3.0	Stereo	BL01UMXA		0	2049	HDPN RT	1.0.1.0	Stereo	BL01Hdpn	
0	3330	UMix-1 Out B LT	1.0.3.1	Stereo	BL01UMXB		0	3328	UMix-1 In 1 LT	1.0.3.0	Stereo	BL01UMX1	
0	3331	UMix-1 Out B RT	1.0.3.1	Stereo	BL01UMXB		0	3329	UMix-1 In 1 RT	1.0.3.0	Stereo	BL01UMX1	
0	4096	Surface	1.1.0.0	Stereo	L8 PGM		0	3330	UMix-1 In 2 LT	1.0.3.1	Stereo	BL01UMX2	
0	4097	Surface	1.1.0.0	Stereo	L8 PGM		0	3331	UMix-1 In 2 RT	1.0.3.1	Stereo	BL01UMX2	
0	4098	Surface	1.1.0.1	Stereo	L8 AUD		0	3332	UMix-1 In 3 LT	1.0.3.2	Stereo	BL01UMX3	
0	4099	Surface	1.1.0.1	Stereo	L8 AUD		0	3333	UMix-1 In 3 RT	1.0.3.2	Stereo	BL01UMX3	
0	4100	Surface	1.1.0.2	Stereo	L8 AUX		0	3334	UMix-1 In 4 LT	1.0.3.3	Stereo	BL01UMX4	
0	4101	Surface	1.1.0.2	Stereo	L8 AUX		0	3335	UMix-1 In 4 RT	1.0.3.3	Stereo	BL01UMX4	
0	4102	Surface	1.1.0.3	Stereo	L8 OL		0	3336	UMix-1 In 5 LT	1.0.3.4	Stereo	BL01UMX5	
0	4103	Surface	1.1.0.3	Stereo	L8 OL		0	3337	UMix-1 In 5 RT	1.0.3.4	Stereo	BL01UMX5	
0	4104	Surface	1.1.6.0	Stereo	L8 CR		0	3338	UMix-1 In 6 LT	1.0.3.5	Stereo	BL01UMX6	
0	4105	Surface	1.1.6.0	Stereo	L8 CR		0	3339	UMix-1 In 6 RT	1.0.3.5	Stereo	BL01UMX6	
0	4106	Surface	1.1.6.1	Stereo	L8 Stu		0	3340	UMix-1 In 7 LT	1.0.3.6	Stereo	BL01UMX7	
0	4107	Surface	1.1.6.1	Stereo	L8 Stu		0	3341	UMix-1 In 7 RT	1.0.3.6	Stereo	BL01UMX7	
0	4108	Surface	1.1.6.2	Stereo	L8Hdpn		0	3342	UMix-1 In 8 LT	1.0.3.7	Stereo	BL01UMX8	
0	4109	Surface	1.1.6.2	Stereo	L8Hdpn		0	3343	UMix-1 In 8 RT	1.0.3.7	Stereo	BL01UMX8	
0	4110	Surface	1.1.5.0	Mono	L8 CUE		0	4096	Surface	1.1.0.0	Stereo	L8In01	
0	4111	Surface	1.1.3.0	Mono	L8BM01		0	4097	Surface	1.1.0.0	Stereo	L8In01	
0	4112	Surface	1.1.3.1	Mono	L8BM02		0	4098	Surface	1.1.0.1	Stereo	L8In02	
0	4113	Surface	1.1.3.2	Mono	L8BM03		0	4099	Surface	1.1.0.1	Stereo	L8In02	
0	4114	Surface	1.1.3.3	Mono	L8BM04		0	4100	Surface	1.1.0.2	Stereo	L8In03	
0	4115	Surface	1.1.3.4	Mono	L8BM05		0	4101	Surface	1.1.0.2	Stereo	L8In03	
0	4116	Surface	1.1.3.5	Mono	L8BM06		0	4102	Surface	1.1.0.3	Stereo	L8In04	
0	4117	Surface	1.1.3.6	Mono	L8BM07		0	4103	Surface	1.1.0.3	Stereo	L8In04	

The Wire Info Tab allows the user to see all the “wires” used on the selected BLADE. No changes can be made here. Edits to Source or Destination Audio Signals, using the Wire Info tab in the wizard will be reflected here once the signal is saved. Additionally buttons are provided below to allow the user to export either Sources or Destinations or the complete wire info set to a .csv file. This file can be used to import into a spreadsheet or other external database to maintain information about how the system is configured.

Visibilities Tab

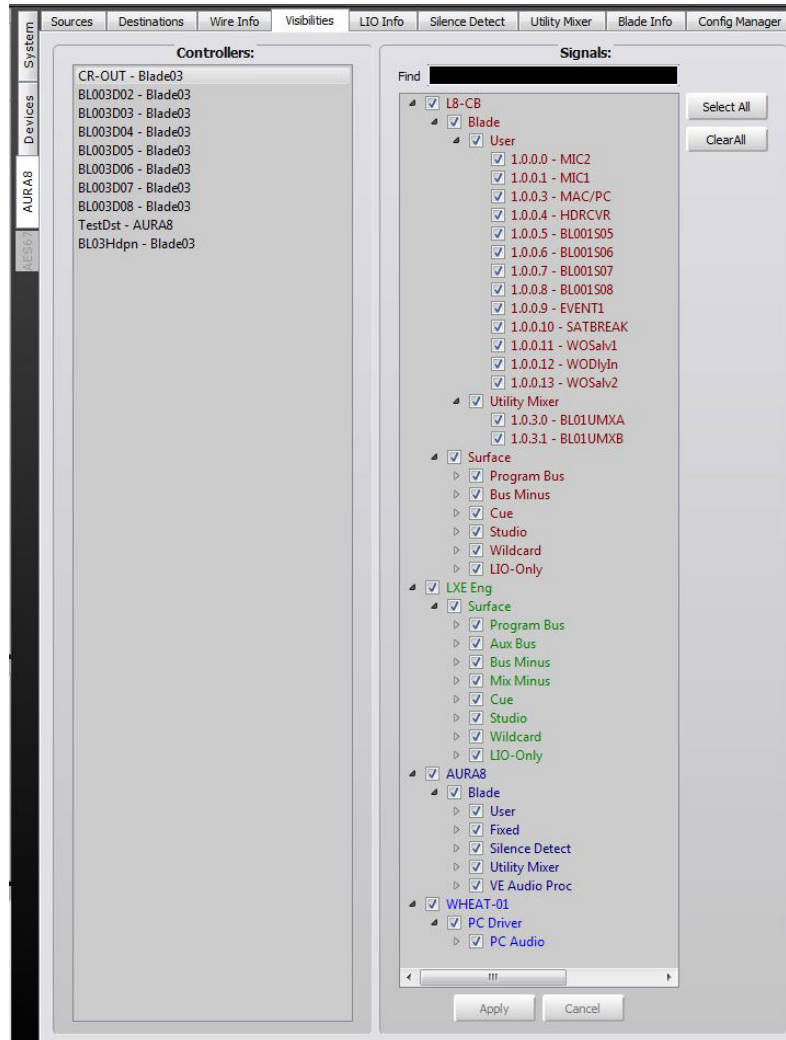

The third tab is the “Visibilities” tab. The settings available on this tab are used to limit or control the choices that can be made for connecting sources to the local audio destinations in the BLADE 3. The default settings of the WheatNet-IP system allow any source to be connected to any destination, but there are some good reasons to restrict this capability in specific places. A good sized system can have hundreds and hundreds of sources available. To locate and select any particular one from the front panel control on a BLADE 3 might involve a lot of scrolling! If you can limit the number of choices available it becomes less confusing and much easier. In many cases it makes practical sense to restrict the source choices. For example, if one of the destination outputs from a BLADE 3 is being used as a headphone feed to a guest location in a talk studio for WXYZ, why would that guest ever need to select the audition mix output of a production studio in WZZZ? Another good reason for restrictions is that you might never want a connection such as the feed from your processor to your air chain to be inadvertently changed. In many cases you can greatly restrict the source choices available for a destination, sometimes even to as few as one. In the WheatNet-IP system, we use the “visibilities” property to control these choices, and it’s very easy to do. Essentially, we allow you to edit the list of names that are “visible” to the user on a destination by destination basis, so that every audio output in the system can

have a unique setting. Note that we are not actually restricting the connection possibilities; you can at any time choose any source you want using the Navigator GUI or by firing a salvo, etc. We are only restricting which choices are visible to a user sitting in front of the BLADE 3 and scrolling the front panel knob.

Clicking on the Visibilities tab opens a new window showing two columns. The left hand column, labeled “Controllers:” shows a list of every local destination defined for the BLADE. The right hand column shows a hierarchal view (typical Windows Explorer tree style) of every source defined in the system.

To set visibility for a destination, first make sure the desired destination is actually a member of the BLADE you are currently viewing. You can check on the Blade tab; it will read “BladeXX” where “XX” is the BLADEID number. If this is not the correct BLADE, then just click on the correct icon in the system pane window to get to the correct visibility tab.

Examine the list of destinations in the left hand window and left click on the desired destination to highlight it. The right hand window shows a list of all of the BLADEs in the system, with a check box beside the name of the BLADE.

If you know that none of the sources in a particular BLADE should be visible to the destination, click on the check box to uncheck it. In this manner, go through the list of BLADEs and uncheck any that should not be visible. Continue on and click on the expand box for any BLADE that you want visibility to some, but not all, of its signals. The list expands in tree fashion to show the individual signals within the BLADE, each with their own check boxes. Uncheck the signals that should not be visible, and repeat this process for any other BLADEs to set them.

When you have completed working on the list for the selected destination, you can click on another destination in the left hand window and set visibilities for it. After setting visibilities for all of the destination signals, click on the *Apply* button at the bottom of the window and your choices will be instantly forwarded to each BLADE in the system.

As you no doubt have noticed by now, this process can be somewhat time consuming. Fortunately, the WheatNet-IP GUI has some built in shortcuts that can be very useful. The *Select All* and *Clear All* buttons in the upper right corner of the visibility window allow you to check or uncheck groups of signals at once, assuming that the common selections are suitable for each member of the group. You can accept these common selections, or then drill down through the menu and make individual tweaks without having to repeat the selections that were in common.

LIO Info Tab

System	Sources	Destinations	Wire Info	Visibilities	LIO Info	Camera Direct	Utility Mixer	Blade Info	Config Manager	Audio Player
Devices	Pin Name	Input	Output	Function	Signal	Fire Salvo	Momentary Connection		Take Preset	
LB-CB	Blade LIOs									
AES6	LIO 1 Pin 2	<input type="radio"/>		<none>	<none>	<none>	<none>		<none>	
	LIO 1 Pin 3	<input type="radio"/>		<none>	<none>	<none>	<none>		<none>	
	LIO 1 Pin 4	<input type="radio"/>		User 1	SATBREAK	<none>	<none>		<none>	
	LIO 1 Pin 5	<input type="radio"/>		<none>	<none>	<none>	<none>		<none>	
	LIO 1 Pin 6	<input type="radio"/>		<none>	<none>	<none>	<none>		<none>	
	LIO 1 Pin 7	<input type="radio"/>		<none>	<none>	<none>	<none>		<none>	
	LIO 2 Pin 2	<input type="radio"/>		Remote On	EVENT1	<none>	<none>		<none>	
	LIO 2 Pin 3	<input type="radio"/>		<none>	<none>	<none>	<none>		<none>	
	LIO 2 Pin 4	<input type="radio"/>		<none>	<none>	<none>	<none>		<none>	
	LIO 2 Pin 5	<input type="radio"/>		<none>	<none>	<none>	<none>		<none>	
	LIO 2 Pin 6	<input type="radio"/>		<none>	<none>	<none>	<none>		<none>	
	LIO 2 Pin 7	<input type="radio"/>		<none>	<none>	<none>	<none>		<none>	
	Software LIOs									
	Functional LIOs									
	AES Input Error CH5	X		<none>	<none>	<none>	<none>		<none>	
	AES Input Error CH6	X		<none>	<none>	<none>	<none>		<none>	
	AES Input Error CH7	X		<none>	<none>	<none>	<none>		<none>	
	AES Input Error CH8	X		<none>	<none>	<none>	<none>		<none>	
	Surface 1 Spares									

The fourth tab is the “LIO Info” tab. This tab brings up a screen you can use to program and control the operation of the 12 physical Logic Input/Output ports on each BLADE 3. These ports are available on the two RJ-45 jacks on the rear of the BLADE 3. Each of these 12 ports can be individually defined as a logic input or a logic output, and can be mapped to a number of different functions.



WheatNet-IP Rear

The LIO info tab is arranged as a table, with logic ports listed along the left side, and attributes listed across the top. Each row, or line, therefore shows the logic settings for a particular logic port. Recall that each BLADE3 has twelve ports available; they are named LIO 1 pin 2 through LIO 1 pin 7, representing the six logic ports available on the first RJ-45 rear panel logic jack, and LIO 2 pin 2 through LIO 2 pin 7, representing the six logic ports available on the second RJ-45 rear panel logic jack. The logic port names not so subtly reflect the physical pin number of the logic jack, so it is easy to correlate the GUI functions with the corresponding physical connection. These pin numbers have been chosen so they mate up with some common Wheatstone auxiliary switch panels; when they are used for logic outputs, power is available on pins 1 and 8.

The logic functions that have been programmed will appear in this table, giving you an at-a-glance summary of the physical logic ports on the BLADE3. In the row for a particular port you will see whether it has been programmed as an input or an output, the name of the logic function configured for the port (if one has programmed), the eight character name (the one that appears on the crosspoint grid) you’ve given to the logic signal, the salvo it has been programmed to fire, or the temporary XPoint connection it has been programmed to trigger. Note that the three possible uses of the logic port are mutually exclusive; a logic port can be programmed as a logic only signal for use in connecting to other logic signals on the grid, or it can be programmed to fire a salvo, or it can be programmed to trigger a connection. It can only do one of these things.

The LIO Info tab shows which programming options have been set for each of the 12 physical ports. If nothing has programmed, the info will be shown as “<none>.”

An especially handy feature of this window is that each logic port has an associated indicator with it. These are the circles shown in the input or output columns next to the logic port name. When the logic port is triggered, these indicators will light up in color for as long as the port stays triggered. This makes it easy to trace out your wiring to the ports; if you wire up a switch as an input to the logic port, the associated indicator will turn color as long as you hold the switch button down. Conversely, if you’ve wired up a logic port as an output to drive a relay, lamp, or other device, the associated indicator will turn color as long as the logic output is activated by whatever you intend to drive this output with (presumably a console logic signal, another switch panel somewhere, or so forth).

Pin Name	Input	Output	Function	Signal	Fire Salvo	Momentary Connection	Take Preset
Blade LIOs							
LIO 1 Pin 2	<input type="radio"/>		<none>	<none>	<none>	<none>	<none>
LIO 1 Pin 3	<input type="radio"/>		<none>	<none>	<none>	<none>	<none>
LIO 1 Pin 4	<input type="radio"/>		User1	SATBREAK	<none>	<none>	<none>
LIO 1 Pin 5	<input type="radio"/>		<none>	<none>	<none>	<none>	<none>
LIO 1 Pin 6	<input type="radio"/>		<none>	<none>	<none>	<none>	<none>
LIO 1 Pin 7	<input type="radio"/>		<none>	<none>	<none>	<none>	<none>
LIO 2 Pin 2	<input checked="" type="radio"/>		Remote On	EVENT1	<none>	<none>	<none>
LIO 2 Pin 3	<input type="radio"/>		<none>	<none>	<none>	<none>	<none>
LIO 2 Pin 4	<input type="radio"/>		<none>	<none>	<none>	<none>	<none>
LIO 2 Pin 5	<input type="radio"/>		<none>	<none>	<none>	<none>	<none>
LIO 2 Pin 6	<input type="radio"/>		<none>	<none>	<none>	<none>	<none>
LIO 2 Pin 7	<input type="radio"/>		<none>	<none>	<none>	<none>	<none>
Software LIOs							
Functional LIOs							
AES Input Error CH5	X		<none>	<none>	<none>	<none>	<none>
AES Input Error CH6	X		<none>	<none>	<none>	<none>	<none>

Beside 12 physical Logic ports Navigator GUI provides 128 Software ports.

Silence Detect Tab

The fifth tab is the “Silence Detect” tab. One of the very powerful features of the WheatNet-IP system is that every single audio output channel can be programmed with a silence detection and automatic switch over function. This capability can go a long way to maintaining smoother, more reliable operation to your radio stations when an unexpected problem happens. Careful planning of alternate and back up audio paths for crucial connections can keep you on the air.

While the silence detect function is available for every destination signal in each BLADE3, it is not automatically enabled. Many of the signals in a typical system do not need this function. To enable silence detect for a particular destination signal, you must click on the Destinations tab for the BLADE in which the signal is located, click on the desired signal to highlight it, and then click on the *Edit...* button to open the familiar “Destination Signal Wizard” window. You will notice the Silence Detect check box; if it has not been checked, silence detection will not be enabled for this audio channel.

When you click on the silence detect check box and finish the signal wizard, several things happen.

First, the silence detect function is enabled. Second the silence detect alarm logic signal (default name is “XXXL” where XXX is the name of the destination signal you are working on) is automatically created as a Source Signal to generate messages in the “Alarms” pane of the GUI and to allow connection to a physical logic output port to activate an alarm device. Finally, a new audio destination signal is automatically added into the BLADE (and the system). This signal is created with a default name of “XXXB” (where XXX is the name of the signal you are working on) and represents the secondary audio path that can be used for automatic failover of your source connection upon detecting silence. Create a back up signal path by making a source connection from your back up source to this secondary “B” connection (it will show on the crosspoint grid).

Clicking on the Silence Detect tab for a BLADE opens up a three part window.

The upper left hand window part is labeled “Destination Signals” and shows a list of any destinations that have been set up for silence detection. The upper right hand window part is labeled “Settings” and shows the particular level and duration parameters that have been chosen (or the standard default settings). The bottom window part, called “Status” shows details about the current state of the silence detect function.

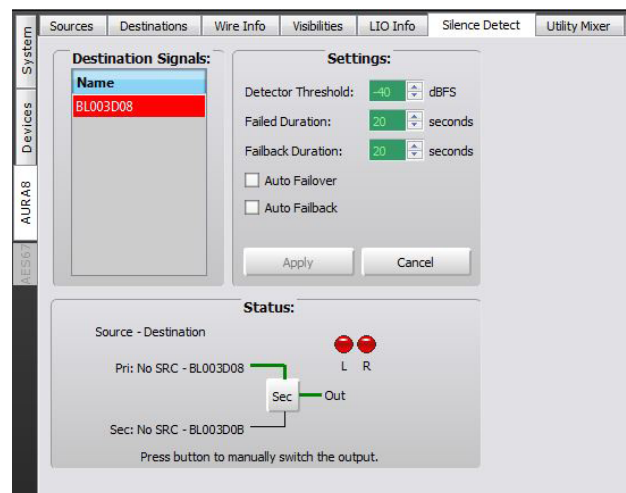
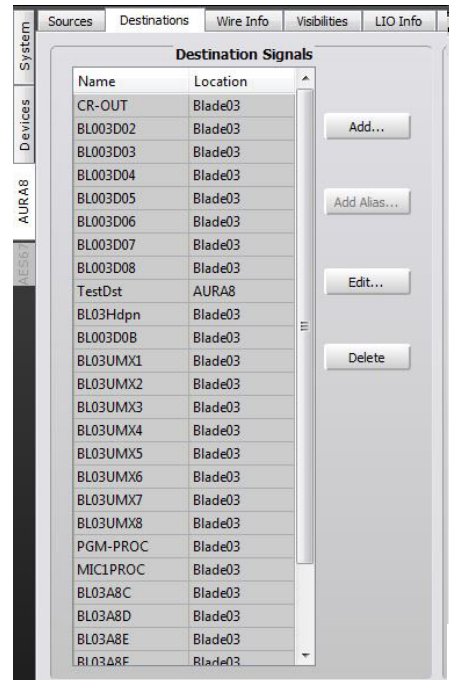

Destination Signals

To experiment with the silence detect function, click on one of the destinations in the “Destination Signals” list. The “Settings” and “Status” areas of the window will change to show the particulars for the selected destination signal. If there are no destinations shown in the list, that means silence detection has not been enabled yet for any of the signals in the BLADE 3. In the right hand “settings” area you can modify the default settings or leave them as the defaults.

Settings

You can review the effect of the settings in the “Status” area of the window. These settings are:

Detector Threshold – This is the signal level threshold for silence detection. Any time the audio signal at the destination falls below this threshold, the BLADE3 will start to keep track of how long the signal stays below this threshold level. This setting should be adjusted to match your station’s format. Not to be obvious, but a Hot format most likely never expects to have a low signal level, while a classical format might frequently do so.

Failed Duration – This is the acceptable length of time for the signal to be below threshold. It is only applied when the “Auto Failover” check box has been set. Again, this setting is very dependant on your format. If your program material has few, if any, pauses, and your Talent voices are energetic, you can set the duration as low as several seconds. Conversely, if your programs have frequent quiet passages and your Talent voices are relaxed you may need to set the duration as high as the maximum duration of 45 seconds.

The Navigator GUI can be helpful in arriving at the optimum settings for threshold and duration. In the Status area of the Silence Detect window are two round indicators labeled “L” and “R.” These are audio indicators that show the left and right channels of the destination. They will be shown in green when the audio level is above the threshold setting, and in red when it is below the threshold setting. If you leave the auto failover box unchecked, you can watch these indicators as you alter the threshold without danger of losing the audio connection due to a silence detect triggered failover. Monitor how frequently and for how long the audio is below threshold, add some extra time margin for insurance purposes, and that’s your settings. Just remember, if your programming or Talent changes, these settings may need to be readjusted.

Failback Duration – This setting can be very useful. It is only applied when the “Auto Failback” check box has been set, and represents how long the BLADE3 will wait to restore the original source connection. It will monitor the original source for level, and, if it stays above the threshold for the specified time, will switch back to the original source. This is useful in situations where the primary connection is intermittent; by specifying a duration over which the primary connection must “prove itself good” you can avoiding a premature switch back before the connection is solid.

The other two controls in the “Settings” area of the Silence Detect tab are the previously mentioned check boxes for “Auto Failover” and “Auto Failback.” Check the “Auto Failover”

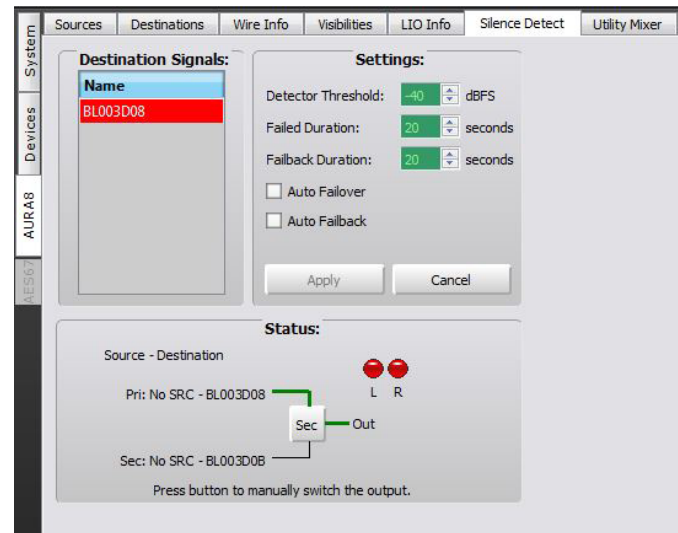

box if you would like to have an automatic source connection change to your specified secondary source when silence detect is triggered. Check the “Auto Failback” box if you would like to have an automatic source connection changed to your primary source when the silence detect function is released.

Finally, you must click on the *Apply* button at the bottom of the window before any of your changes will take effect.

Status

The “Status” area of the Silence Detect tab shows at a glance information about the silence detect function for the destination signal. The primary and secondary connection paths are labeled and indicated, and the “L” and “R” audio level indicators will flicker in the presence of audio. Note that the currently active signal path shows in green and the inactive signal path shows in black. You can click on the *Sec* button to force a connection change to the alternate signal path and a dialog “Manually Switch Output” window will open asking you to confirm the change.

Warning: Clicking *Yes* on the dialog box will instantly change the audio connection. This button is meant to be used for initial set up and testing and for manual failover in cases where automatic failover is not desired, or when the failover is needed for reasons other than the loss of audio signal.

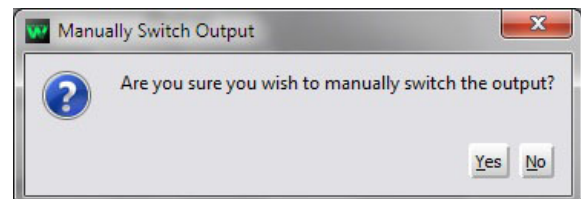
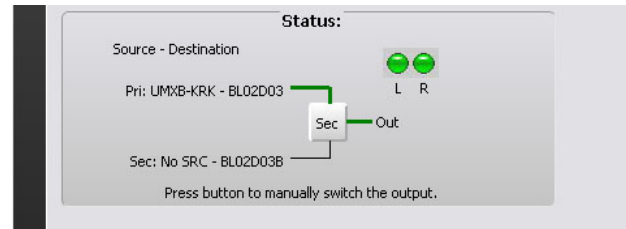

Logic

Enabling Silence Detection on a Destination automatically creates a new Logic Only source signal. This signal will appear in the crosspoint grid with a name of “XXXL” where XXX is the name of the destination using silence detection. This logic signal also has an ID# of XXXXX4XX where XXXXX_XX is the signal ID of the destination.

To use this logic signal to trigger a physical alarm, create a new Logic Only destination signal on the BLADE3 you will use for the physical alarm (light, buzzer, etc.) logic connection. Map the particular logic pin that you want to use and select the “SDet Failure” function from the drop down list.

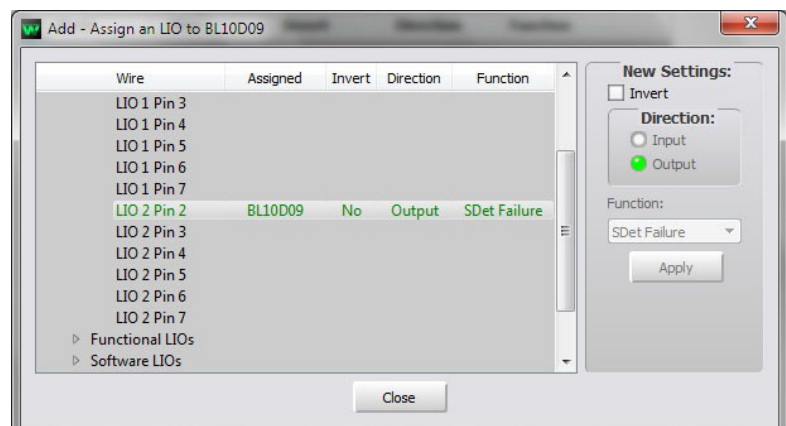

Once you have defined the new Logic Only destination signal, make a new crosspoint connection between the auto generated silence alarm source logic signal and your new alarm destination signal. On detecting silence, the SDet Failure logic function will trigger your destination alarm signal for as long as the silence persists.

Utility Mixer Tab



The next tab is “Utility Mixer.” Each BLADE3 can optionally have a built in audio mixer capability (this tab will be grayed out if it is not available on the BLADE3). Clicking on this tab will open the Utility Mixer window, which shows a graphic representation of an 8 x 2 mixer, complete with faders, meters, and ON switches. There are two different 8 x 2 mixers available on this tab. With each of these mixers, two separate mixes of up to eight audio sources can be created and manipulated. Furthermore, each one of these two 8 x 2 mixers has a separate Automation Control Interface, or ACI, providing for external control of the mixer by a third party program such as an Automation system. Lastly, every physical BLADE 3 in the system can have these two mixers enabled on it simultaneously, so the number of mixes available to you is limited only by how many BLADE 3s you have.

Enabling the Utility Mixer will add (4) new sources labeled BL10UMXA, BL10UMXB, BL10UMXYA, and BL10UMXYB, representing the A and B output channels for each mixer on Blade 10 in this example. Also added will be (16) new destinations, labeled BL10UMX1 - BL10UMX8, representing the eight fader input channels of the first mixer and BL10UMY1 - BL10UMY8 for the eight fader input channels of the second mixer. These

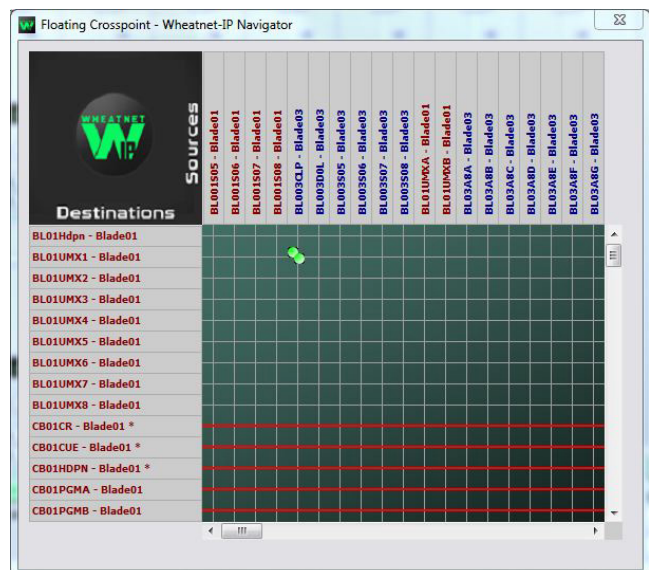

new sources and destinations will appear in the system crosspoint grid, allowing you to connect various system resources, mix them as required, and distribute these mixes to other system destinations.

To operate the Utility Mixer, first be sure it is enabled by clicking on the *Enable* check box. You can separately enable mixer number 1, number 2, or both. This will cause the BLADE to autogenerate the required new signals. Then assign the signal sources needed to fader channels by using the system crosspoint grid. To mix the audio signals, bring up the fader channels to a desired mix output bus by dragging with your mouse and clicking on the channel *ON* button. Adjust the mix by dragging the individual and mix faders up or down. The radio buttons beside each fader provide for automatic *Fade up* or *Fade down* with a variety of speeds. You can monitor the mix by watching the on screen meters, and/or by listening to the mix output on any speaker or headphone output destination. The front panel headphone jack on the BLADE is a good place to do this.

The Utility mixer is handy for a variety of functions. You can use it to premix some standard signals, provide for late night automated operation, set up mix minus feeds, create an intercom system, or even run a small remote.

Blade Info Tab

The screenshot displays the 'Blade Info' tab within the WheatNet-IP Navigator GUI. The interface is organized into several sections:

- Versions:** Displays software and hardware versions.
 - Software Version: 3.7.7 JUN 8 2018 REV2 CPU
 - FPGA Version: EE030414 20171016.1411
 - IO Board Rev: 34
 - IO PCB Id: 6 - CBE3
 - Num DSPs: 0
- Info:** Displays hardware identification information.
 - MAC address: 80:E4:DA:00:11:46
 - Blade Type: IP-88cb
 - Blade ID: 1
- Network Info:** Displays network configuration details.
 - Name: L8-CB
 - IP Address: 192.168.87.101
 - Subnet: 255.255.255.0
 - Gateway: 192.168.87.1
- Master Preference:** Allows for system-wide settings.
 - Route:** Set to 80 (Default), with options for High (90), Med (80), and Low (40).
 - Clock:** Set to 50 (Default), with options for High (90), Med (80), and Low (40).
 - Slave Mode:** Currently unchecked.

The next tab is the “Blade Info” tab. This tab is where the BLADE 3’s current software and firmware versions are displayed, and network settings are displayed and can be modified. Wheatstone recommends leaving these settings unchanged unless you have strong reasons to change the default addresses, are experienced in LAN set up, and have created an address plan for the system.

The “Versions:” part of the window shows the current software and firmware versions running on the BLADE 3.

The “Info:” part of the window shows the BLADE 3’s hardware address information. Every networkable device is built with a unique physical hardware address (called the MAC address) that cannot be changed. This MAC address, along with the BLADE 3’s type and ID information, are displayed for information purposes only in non-editable boxes.

The “Network Info:” part of the window shows the BLADE 3’s software address information. This is the IP address information created by the System Wizard, and takes the form of the familiar IP address, Subnet, and Gateway. It is sufficient to note that these boxes can be edited to change the BLADE 3’s software address.

Note that modifying this address information improperly will cause the BLADE 3 to cease operating on the WheatNet-IP network and potentially become invisible to the WheatNet-IP Navigator GUI. In other words, if you mess this up you may not be able to get back without rerunning the System Wizard from the front panel of the BLADE 3.

The one setting that you might consider changing is the BLADE 3 name. This is the name that will identify the BLADE 3 in the System Pane and elsewhere. The system default name for the BLADE 3 is “BladeXX” where “XX” is the BLADE ID number. You can leave the BLADE 3 name as the default, or change it to any eight character name by dragging or double clicking on the name and typing a new one. Just remember that

each BLADE 3 needs a unique name to let you identify it in the system. Click on the *Apply* button in order to save any changes.

The “Route Master Preference:” part of the window is a way to influence the WheatNet-IP Route Master selection process in the system. The Route Master is the BLADE 3 that handles all of the BLADE-to-BLADE communications during normal operations (see page 5-18 for details). These settings should be left as defaulted unless instructed otherwise by a Wheatstone engineer.

Config Manager Tab

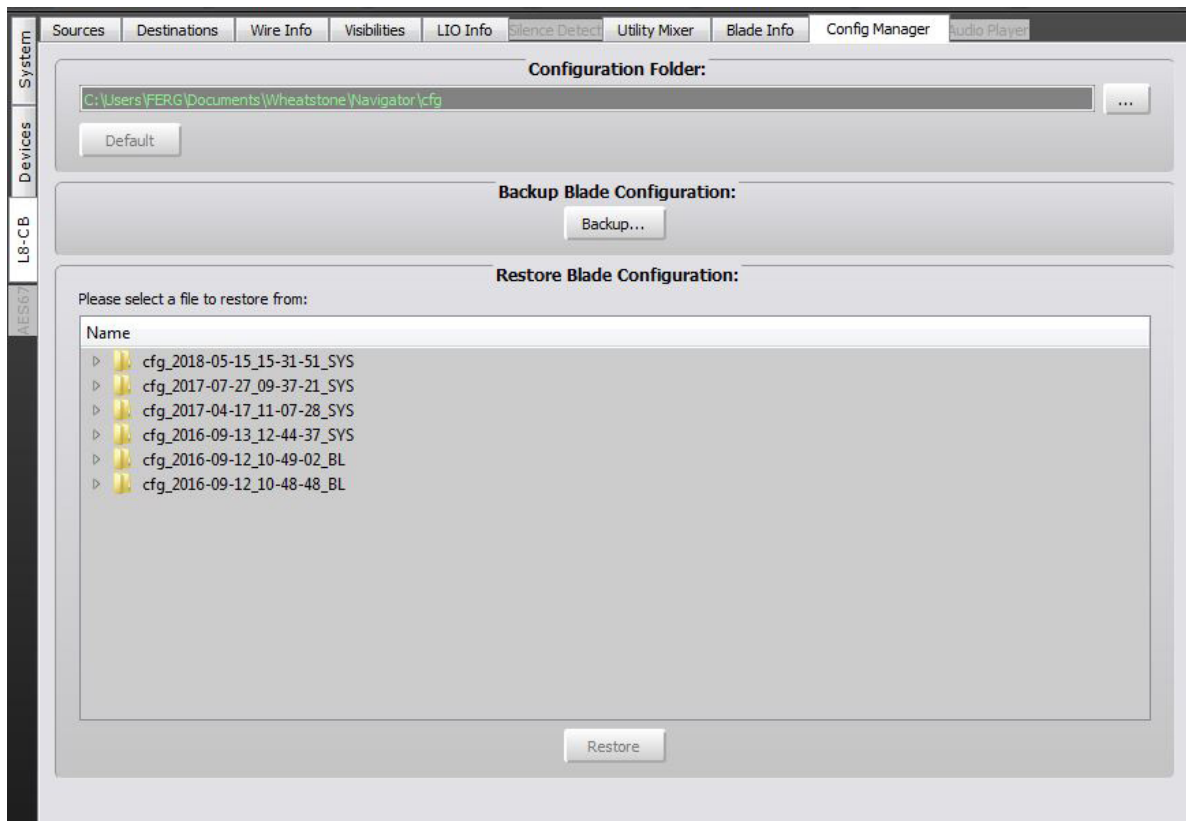

The next BLADE3s tab is the “Config Manager” tab, which gives access to backup or restore the BLADE 3’s specific configuration information. All of the BLADE 3’s signal ID’s, names, format, logic settings, silence detect settings, etc., can be saved to a directory on the GUI PC. Likewise, all of this information can be retrieved from the PC and restored to the BLADE 3.

The “Configuration Folder:” section of the window is used to specify the directory path on the GUI PC to be used for the backup and restore functions. The currently specified path will show in the text box in this section. To specify another folder, click on the browse button next to the text box. A standard Windows dialog box will open allowing you to specify the desired directory. If desired, you can assign this directory as the default location for configuration files by clicking on the *Default* button.

The “Backup BLADE3 Configuration” section of the window is even simpler. All it contains is a *Backup* button which, when

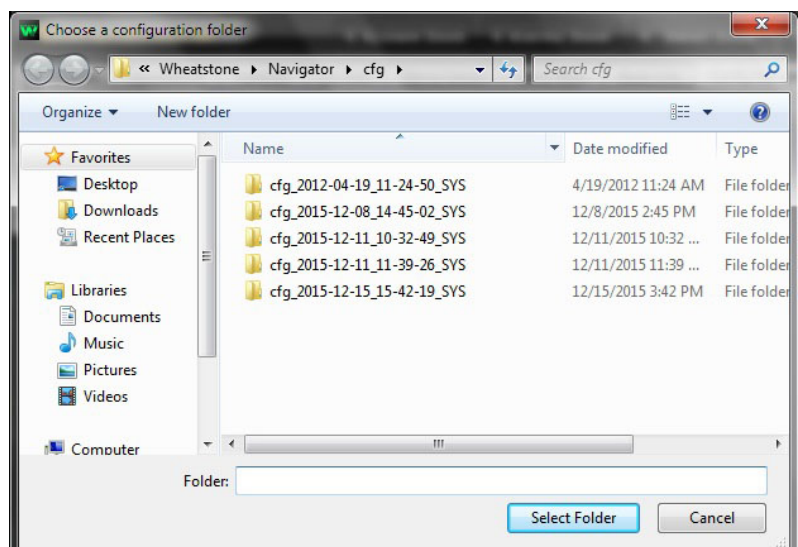

clicked, will write all of the configuration information to the specified directory. First a subdirectory is created, and is named “cfg_YYYY-MM-DD_HH-MM-SS_BL” where YYYY-MM-DD is the current date and HH-MM-SS is the current time. This automatic naming convention makes it easy to keep track of your backup files. Click *Yes* on the ensuing dialog box to proceed (clicking *No* will cancel the operation).

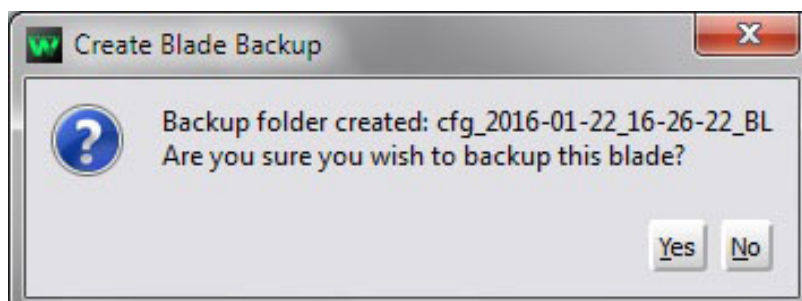

A file will be created with a name of the form “full_BLADE_config_XXXX” where “XXXX” is the BLADE 3 ID number.

The last section of this tab shows the “Restore Blade Configuration” section. Here you can scroll through the list of available configuration directories and files, click on one to highlight it, and then click on the *Restore* button to send the information to the BLADE 3. A restore dialog box will open showing the selected file and asking you if you are sure. Clicking *Yes* will again show a progress bar as the information is uploaded to the BLADE 3.

A Word About Backup and Restore

Because of the distributed intelligence of the WheatNet-IP system, the backup function is mainly intended for archival purposes. Since all of the system’s information is concurrently saved in flash memory on multiple BLADE 3s, it is extremely unlikely that it all would be lost. So why then do we need to perform backups? It would take a catastrophic event, such as a direct lightning strike or massive flooding that simultaneously wipes out all of the BLADE 3s, in order for all of this information to be lost. Maintaining a regular schedule of backups is a good way to mitigate against this unlikely but still possible scenario.

Because the Navigator GUI is so powerful, Wheatstone has provided in the WheatNet-IP system for up to four copies to be running at the same time. You can be running a copy in your TOC, running another copy down the hall, and even run a copy from your home if you have provided for external access into your system. This functionality can be handy for managing connection, silence detection, and logic functions. Be aware, however, that the backup and restore functions work in concert with the directories on a particular PC, so to avoid confusion it is best to restrict these activities to only one PC.

Audio Player Tab

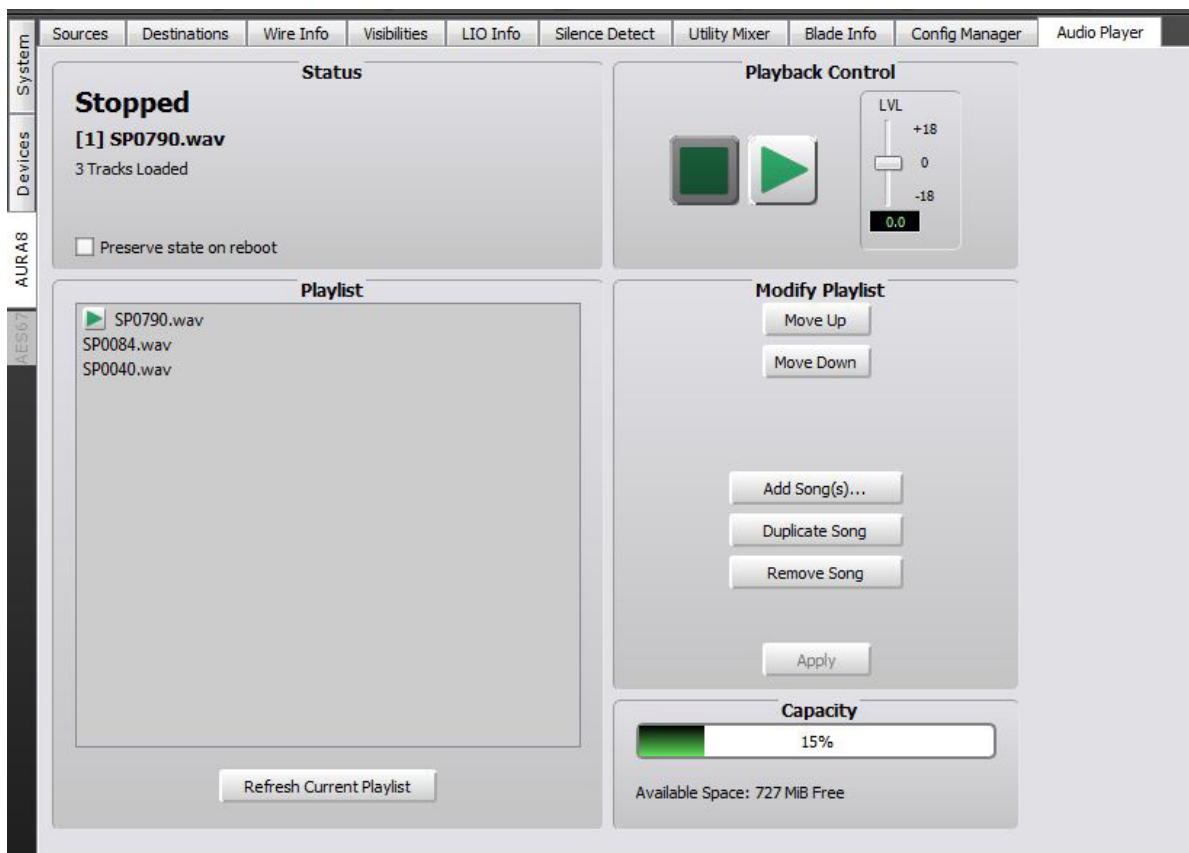

The last BLADE 3s tab is the “Audio Player” tab. There is an optional built-in audio clip player that can be used to put emergency audio on the air. The files are managed in Navigator where you can add files, organize the playlist, and fire playback. Silence or an LIO event can trigger this playback, or it can be manually controlled from Navigator.

Status

This pane shows the current status of the Audio Clip Player.

Playlist

The audio clips will playback in the order shown on the list.

Capacity

The Clip Player will only play uncompressed audio files (.wav format). To play properly the audio files should be recorded at the same sample rate as the WheatNet-IP system. The Clip Player can hold slightly more than 1 hour of uncompressed audio and the capacity pane will show the literal and percentage capacity available.

Modify Playlist

In this pane you can add/remove audio clips and set the playback order.

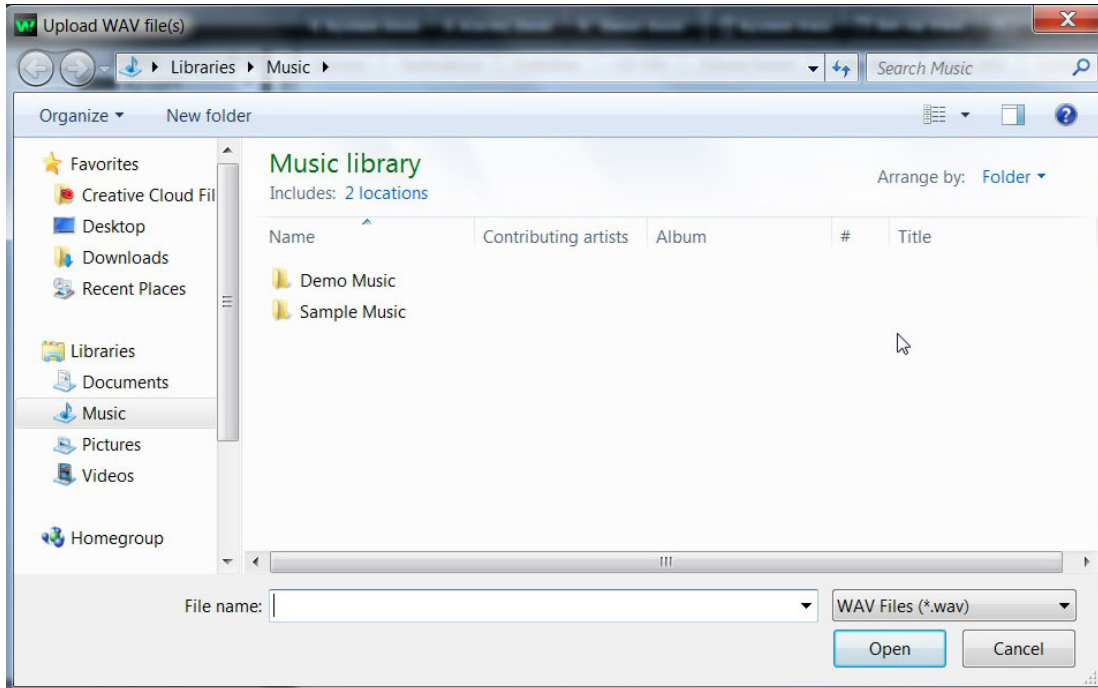

Playback Control

This pane provides direct stop/start control of audio playback and has a level control to adjust playback volume.

More on the System Pane

Popup menus are available when a BLADE3's icon or name is right-clicked in the System Pane. Additionally, the view in the main window area changes as if the icon or name was left-clicked.

If the BLADE3 type is any of the hardware BLADE3s, the popup menu allows you to choose any of the tabs in the main view. This is most handy when you want to change to a tab that's currently not visible and would require use of the tab scroll buttons to make that tab show before selecting it. With the right-click method you don't need to use the tab scroll buttons.

There are two additional entries in the popup menu for a hardware BLADE3. At the top is a choice to "Go to Crosspoint," which changes the main view to the System Crosspoint tab. At the bottom of the menu is a choice to "Reboot BLADE3." This should be used with caution, since the BLADE3 will be out of commission for the reboot time, and any audio in the BLADE3 will be lost to the system until reboot is done. The main reason for providing "Reboot Blade" is to allow you to reboot a BLADE3 when updating its software without having to physically travel to where the BLADE3 is located.

If the BLADE3 is a PC type, the popup menu once again lists the tabs for that BLADE3 as choices, and also sports the "Go to Crosspoint" choice. There is, however, no "Reboot BLADE3" choice.

You can also right-click on the System icon or name to bring up a similar menu. Since one of the choices is already the System Crosspoint tab, there is no need to have the "Go to Crosspoint" choice, so that item is omitted from the list. And the bottom choice is not "Reboot Blade" but, instead, is "Reboot All Blades." Once again, this choice needs to be used with caution.

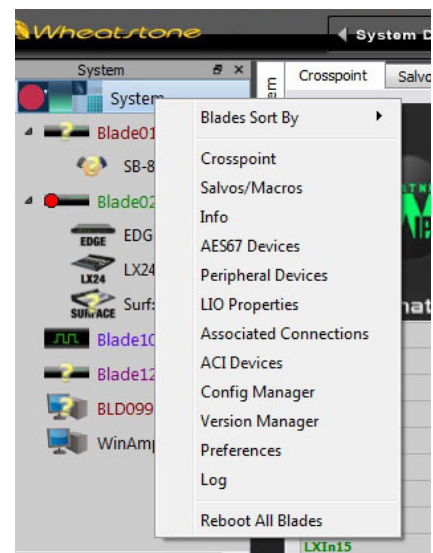
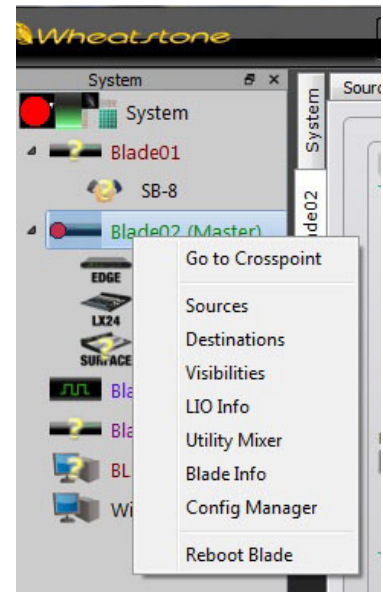

Aura1ip Pro GUI

Chapter Contents

Routable Audio Processing	6-3
A Word About Our Controls	6-5
Input Controls	6-5
High Pass Filter (HPF)	6-5
AGC and Compressor Controls - Part 1	6-5
AGC Backoff.....	6-6
Band Coupling.....	6-7
Gate Thresh, Gate Delay, and Gated Mode	6-7
Number of Bands	6-8
Crossovers	6-8
AGC and Compressor Controls - Part 2	6-9
Threshold.....	6-10
AGC Attack/Release.....	6-10
Compressor Attack/Release	6-10
Compressor Ratio	6-11
Gate Offset	6-11
Processing Band L+R and L-R Outputs.....	6-12
Makeup Gain	6-13
Parametric EQ	6-14
A Word About Our Limiters	6-16
Multiband Limiter	6-16
Threshold	6-16
Limiter Attack	6-17
Limiter Release.....	6-17
Output Trim.....	6-17
Multiband Limiter Options.....	6-17
Look Ahead Final Peak Limiter	6-18
Final Lim Drive.....	6-18
Attack	6-18
Release.....	6-18
Delayed Release Control.....	6-18
Look Ahead Limiter Special Option Checkboxes	6-18
Output Control.....	6-19

Metering Discussion 6-20

Input Metering 6-20

Gain Reduction Meters 6-20

Output Metering 6-21

Sidebar Region 6-22

Preset 6-22

Library 6-23

Devices..... 6-24

Quick Save 6-24

Title Bar Region 6-26

Status 6-26

Devices..... 6-26

Presets 6-26

Accessing Menu Option..... 6-27

File Menu Items 6-27

Hardware Menu Items 6-27

Preset Menu Items 6-27

Aura1ip Pro GUI

Routable Audio Processing

The BLADE 3s include an optional multiband processor useful for processing incoming audio from callers, remotes, codecs, satellite feeds and microphones. This is one instance of the same Vorsis processing used in the acclaimed Aura8ip BLADE. You can also use it to process output audio for headphones, web streams, pre-processors, IFB, or for level protection for STL applications. This is a routable processor that includes a 4-band parametric equalizer, a 3-way crossover, 3 compressors, 3 limiters, and a final look-ahead limiter.

We will address all of the available adjustments and help familiarize you with what the adjustments do, but first you will need to install and setup the GUI.

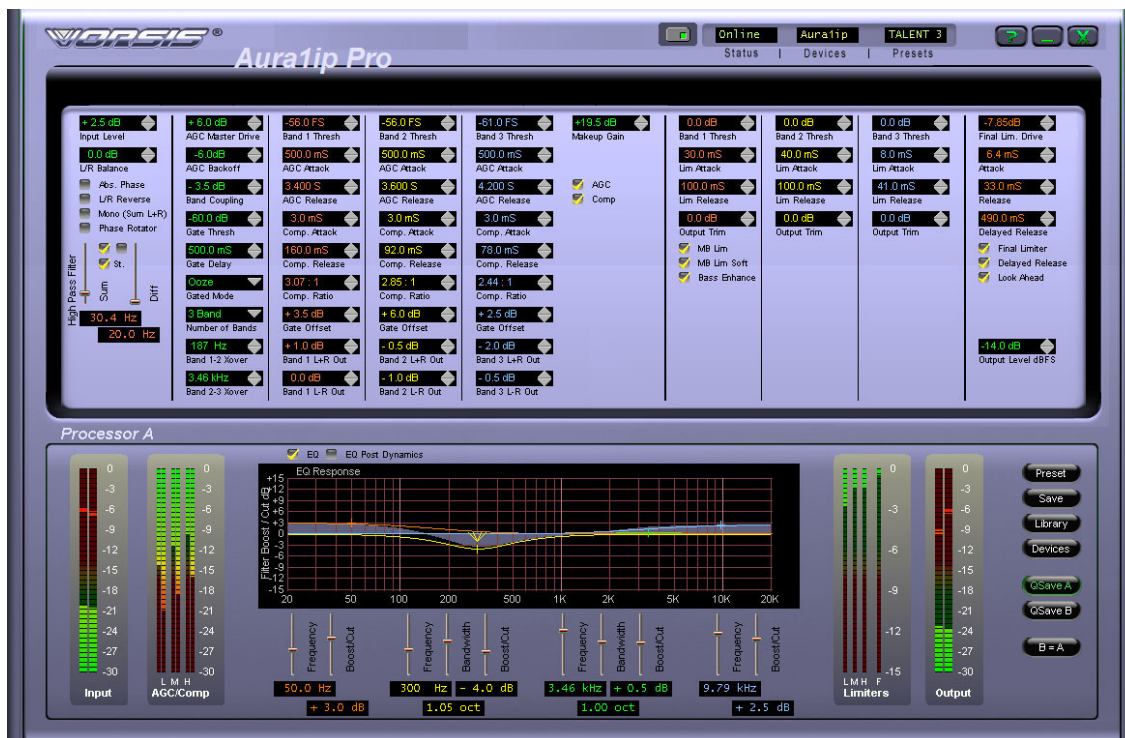

The Aura1ip Pro GUI software is provided on a software CD shipped with the product and once installed, grants easy access to Aura1ip's vast sound processing capabilities. Installing the software is easily done using the following procedure:

- Insert the Aura1ip software CD into a Windows computer;
- Click the Start button;
- Click the Run option;
- Click the Browse option;
- Browse *My Computer* to locate the CDROM device and double click it;
- When the contents of the CDROM drive appears, locate the Aura1ip_Pro_x.x.x.exe file (where x.x.x. is replaced by the version number) and double click it to start the GUI installation;
- Follow the on screen instructions to complete GUI installation.

Once the GUI has been installed on the host PC it must be configured before it can connect to and control the Aura1ip processor.

Click the Aura1ip_pro.exe file to start the Aura1ip Pro GUI software and use the following procedure to configure it to be able to connect and control the Aura1ip processor.

- On the bottom right hand side of the GUI, click on the *Devices* button, then click the *Add...* button; the Edit Device dialog will open.

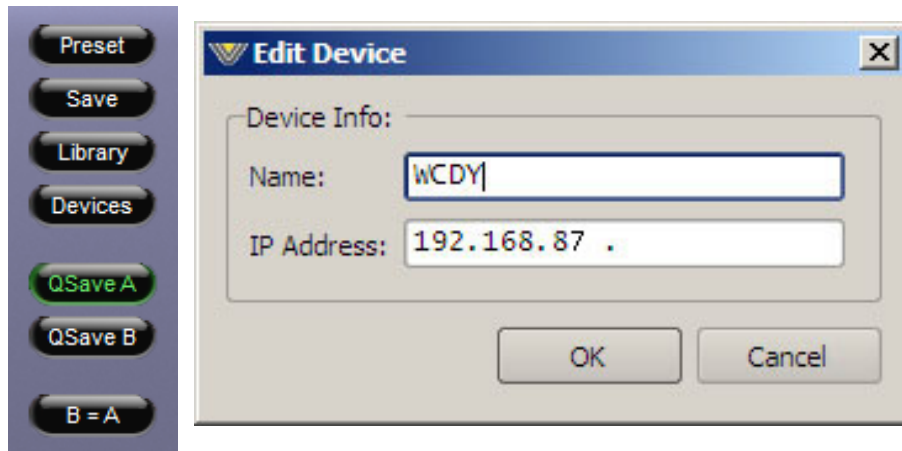

- Insert a name for the BLADE3. This is the name that will be displayed at the top of the GUI to inform the user which BLADE3 is currently connected.
- Next enter the IP address of that BLADE3.
- Click the *OK* button to close the dialog.
- Highlight the newly configured device and click the *Select* button.

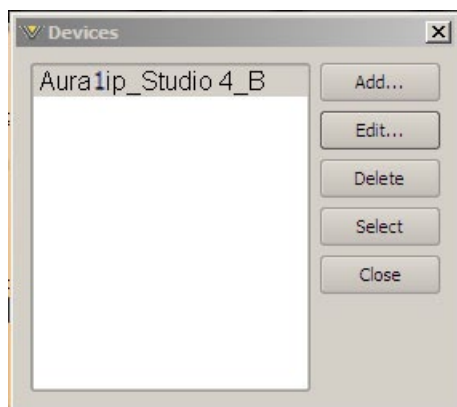

If there is a network connection between the GUI's host PC and the BLADE3, *and* the PC is configured to be on the *same* network subnet as the BLADE3, the *Online* button at the top left of the GUI may be clicked to connect to the BLADE3. When the GUI is online to the processor and controlling it, the green indicator inside the button will be illuminated and the Status window will display "Online."



IP Address Note: Unless special routing has been configured by the IT department the controlling PC *and* the BLADE3 must be on the same network subnet. As an example, if the Aura1ip has an IP address 192.168.87.101, then the PC's IP address must be configured to be *between* the addresses 192.168.87.1 and 192.168.87.254, noting that the BLADE3 and the host PC cannot share the *same* IP address.

A Word About Our Controls



The control at left is typical of those found in the Pro GUI. To increase its value, left click on the UP arrow. To decrease its value, left click on the DOWN arrow. If you wish to quickly move to a value, you may click and hold the UP or DOWN arrows and the control will scan to the end of its range.

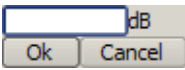

Another option is to double-click in the numeric field of the control which will open up a dialogue where you can input the value you want. If the value is not within the range of the controller, the controller will return to the value within the accepted range that is closest to the requested value.



Controls that have a DOWN arrow but no UP arrow are drop down menus. Usually, only 2 or 3 fixed options are available within this type of control. Click the arrow, select the parameter and the drop down menu will automatically close, having selected and displayed the new value.

Input Controls

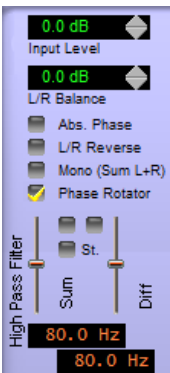

The upper left corner of the Pro GUI hosts the Input settings for the selected processor instance. Here, the input levels and left/right balance can be adjusted, and there are also options for reversing the phase of both left and right channels (Abs. Phase), swapping channels (L/R Reverse) summing the left and right input to mono (Mono (Sum L+R)) and turning on and off the phase rotator.

The input level range is adjustable between -36dB to +12dB with a setting of 0dB referencing a peak input level of -12dBFS. Left/right channel balance may be corrected by +/-12dB from 0dB (default).

High Pass Filter (HPF)

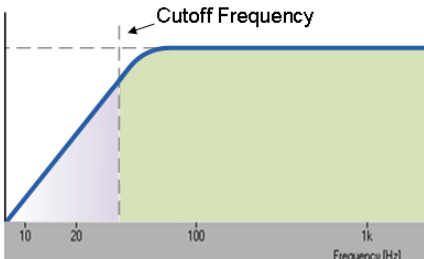

High Pass Filter Response

The purpose of a high pass filter is to remove or reduce low frequency signals that are in the audio, but may not be a desired part of the audio. Whatever frequency is chosen as the Cutoff Frequency is the frequency at which the response to undesired signals will be reduced by 3dB (half power). The high pass response is that of a critically damped fourth order filter.

it has the ability to reduce undesired low frequency noise in the sum (mono) signal, or the difference (stereo) signal, or both. It does this by using its two different high pass filter operating modes as explained next.



Stereo – In the STEREO (St.) mode, the left hand control sets the frequency where the filter begins to work on both sum and difference signals simultaneously. Because the effect is applied to both signals equally, it is mathematically equivalent to the filter being operated in the left/right

domain. As the image at upper left shows, audio signals below the selected frequency are reduced or filtered out.

Sum & Difference – In this mode, two controls separately affect the L+R and L-R aspects of the input audio. Since lower frequencies (generally below 300Hz) are non-directional, eliminating lower frequencies in the L-R domain can yield enhancements to the audio signal above the filter’s frequency. Adjust this control while listening to the bass to find the best setting when using the HPF in this mode.

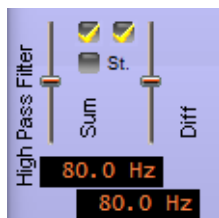

As with all adjustments in the Aura1ip, the high pass filter settings are preset dependent. That is, presets can be saved with the HPF in STEREO or SUM & DIFFERENCE modes, and the preset will remember this.

AGC and Compressor Controls - Part 1

To the right of the Input control column is the column of Master adjustments for the multiband AGC. These adjustments include AGC Master Drive (with a range of -12 to +6 dB), the AGC Backoff control (explained next), Band Coupling, Gate Threshold, Gate Delay, Gate Mode, and lastly, controls for the Number of Bands of processing desired and the Crossover frequency adjustments.



AGC Backoff

This is a very unique control found only in Wheatstone signal processors. The AGC Backoff algorithm decouples the AGC and Compressor processing blocks from each other. When the Backoff control is set to 0dB the AGC and Compressor act as one processor. However, as the Backoff control is adjusted towards -6dB, the AGC and Compressor become more decoupled and begin acting as two separate processors. A better explanation of our AGC Backoff control, a control sometimes called the “Detail” control by our customers, is in order.

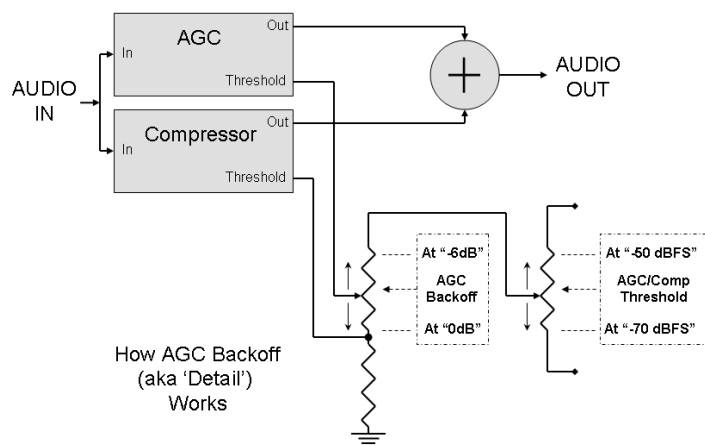

The diagram at left shows the essentials of what the AGC Backoff control does. When the Backoff control is at 0dB the AGC and Compressor are operating with identical thresholds. While their time constants may be different (and typically are) their thresholds, or the audio level where they begin to reduce the level, are the same.

As the Backoff control is adjusted away from 0dB the threshold of the AGC is raised above that of the Compressor. This causes the AGC to

do less work, but since the AGC and Compressor operate as two separate entities they do not see each other, and the Compressor has no idea that the AGC is now doing less work.

The audible effect is that as the Backoff control is adjusted away from 0dB the action of the Compressor becomes more obvious even though it is doing the same amount of work.

In essence, lifting the AGC threshold has exposed the action of the Compressor, which then exposes the audibility of the work that it is doing. Because the AGC/Compressor stage always operate in sum and difference mode, as the Backoff control is adjusted away from 0dB the audibility of processing on L+R and L-R is increased, with the net effect being that the audio becomes more detailed, more alive, has more depth, and is more up front.

It is important to recognize that while the Compressor and AGC operate independently, from a maximum gain standpoint they are linked. That is, at any moment in time the Compressor can never have more gain than the AGC. In fact, when the AGC and Compressor attack a signal at their own time constants and then release, the Compressor can only increase its gain up to whatever gain value the AGC is current at. This behavior is obvious in operation by watching the two meters associated with AGC and Compressor gain reduction as audio is being processed – because the attack time of the Compressor is shorter, it will be reducing gain more than (or faster than) the AGC.

Moving the AGC Backoff setting away from 0dB is one of the places in the processing structure where additional density and loudness may be gained. Basically, you have the ability to not only add or take away compression via the bypass option, but you have the ability to dial in the audibility of that compression in any way desired.

Note that if the AGC Backoff is operated at its maximum value (-6dB), changes to the compressor release times will probably be needed in order to ensure that the audio doesn't become too busy-sounding or overly dense.

Band Coupling

This adjustment controls how much gain could be ADDED by the AGC in Bands 1 and 3 (referenced to Band 2) when energy in those two bands isn't sufficient to cause the same amount of gain reduction as is occurring in Band 2. When Band Coupling is set at 0dB the AGC will prohibit the gains in Bands 1 and 3 from increasing above whatever the current gain in Band 2 happens to be. This prevents Bands 1 and 3 from adding gain when they release, which causes the spectral balance to remain flat. A setting like this is useful in situations where the benefits of multiband gain control are needed but “spectral rebalancing” is not required or desired.

As the Band Coupling control is moved away from 0dB Bands 1 and 3 are allowed to have more gain than Band 2 by whatever the Coupling setting is. For example, setting the control at -6dB will allow Band 1 and 3 to add up to an additional 6dB of gain from Band 2.

It should be noted that the Band Coupling control works only on the AGC. If the AGC is bypassed and the compressor is enabled the compressor does not utilize the Band Coupling controls and therefore it will be allowed to take on as much gain as needed. Also to be noted is that in this mode the compressor will always release to 0dB gain reduction because the compressor itself is not gated, only the AGC. We do not recommend using the compressor by itself unless a specific sound is desired or it is used with light (<6dB) of average gain reduction.

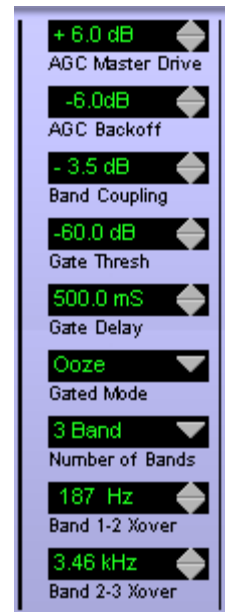

Gate Thresh, Gate Delay, and Gated Mode

Each band of the AGC is managed by a gating algorithm that serves to freeze the AGC's action when audio levels fall below a set value. In effect, that gate manages how the AGC recovers in the absence of audio. Without a gate, the gain would continue to increase as the AGC released, potentially causing noise suck-up or other undesired effects.

The operation of the Gate Thresh control is straightforward. When audio in a processing band falls below the value set by the Gate Thresh control, the AGC will freeze its gain. The compressor may be allowed to decrease gain if needed, but no additional gain increase will occur by the AGC once audio has fallen below this value.

The Gate Thresh is calibrated in dBFS (decibels Full Scale) a common calibration in digital audio equipment. Because the internal audio reference level is -20dBFS (to allow headroom) a normal Gate Threshold setting will be as much as 24dB to 30dB below this value. Therefore it is quite normal to see Gate Threshold settings that are in the range of -44dB to -60dB. The gate function may be defeated by adjusting the Gate Thresh control towards -80dB which will then disable it and cause the Gate Thresh display to indicate OFF.

The Gate Delay setting tells the AGC how long to wait after the audio falls below the Gate Thresh before it freezes the gain. The control range is 50ms to 500ms. Setting the Gate Delay control to times greater than about 100ms loosens up its action which helps gating action when the level of audio passages is just riding the Gate Thresh level.

The Gated Mode control decides if the AGC should freeze the gain when audio falls below the Gate Thresh (Gate), or if it should allow the gain to very slowly recover towards 0dB gain reduction (Ooze). As explained in the introduction, allowing the gain to freeze prevents noise suck-up in the absence of audio. The Ooze function, on the other hand, can be very helpful on formats such as Classical or Jazz, where it might be inappropriate for the AGC gain to get stuck when audio was present, but below the Gate Threshold setting. Using the Ooze mode to allow the gain to slowly recover sounds very natural, and therefore this is the setting that is recommended for the more gentle formats.

Number of Bands

The Aura1ip's AGC, Compressor and Limiter sections may be operated in broadband, 2 band or 3 band modes. Whichever operating mode is selected, the appropriate number of columns of processing controls will appear in the Pro GUI. When switching from 3 Band, to 2 Band, to Broadband mode, columns of controls will be defeated and hidden, revealing only the controls available for the number of bands chosen.



Comparison of AGC controls visible in 3 band mode (left), 2 band mode (center), and broadband mode (right)

Crossovers

The purpose of a crossover (Xover) is to separate the audio spectrum into different frequency bands prior to processing. The reason this is done is to eliminate or reduce the effects of gain control happening in one part of the spectrum from affecting another.

For example, processing bass-heavy material with a broadband (1 band) processor almost inevitably results in an effect called “spectral gain intermodulation,” which simply means that the gain is being arbitrarily changed in one part of the audio spectrum because of signals in another part of the spectrum that need the gain to be changed. Unless this is done to create an effect, spectral gain intermodulation can be annoying as well as fatiguing to listen to.



Aura lip has very flexible phase-linear crossovers which operate at 24dB/octave (4th order). Each crossover may be adjusted within a wide frequency range:

- The BAND 1-2 crossover is adjustable between 20Hz and 687Hz in 3 band mode, or 20Hz and 20kHz in 2 band mode. This band has a wide adjustment range in order to accommodate the requirements of running in two band mode
- The BAND 2-3 crossover has a range of 728 to 20 kHz.

Making the crossover settings by ear is the best way to discover how to set the crossovers for the best sound on the type of material being processed.

In “3 Band” mode, the BAND 1-2 crossover will usually end up between 80Hz and 300Hz while the BAND 2-3 crossover will fall somewhere between 800Hz and 3kHz.

In “2 Band” mode the Band 1-2 crossover will be found somewhere in the range between 120Hz and 400Hz. There is no Band 2-3 crossover setting when the processing is in two band mode in that mode there is no Band 3.

In Broadband mode there are no crossover settings because there is no crossover to adjust.

AGC and Compressor Controls - Part 2

To the right of the AGC Master controls in column #1 are additional adjustments for each of the three AGC/Compressor bands. As pointed out earlier, the number of AGC/Compressor control columns depends on the number of processing bands chosen. We have chosen to color code the controls in each column to make navigation easier. Please note that column #2 and #3 are the only two AGC/Compressor columns serving two roles:

Column #2: Processing adjustments for the lowest frequency band when in 2 or 3 Band mode, or all of the controls when in Broadband mode. The control values in this column are always orange.

Column #3: Processing adjustments for the “Mid” band when in 3 Band mode, or the “High” band when in 2 Band mode. The control values in this column are always yellow.

Column #4 is only visible when the AGC/Compressors are operating in 3 Band mode and it hosts the processing adjustments for the “High” band when in 3 Band mode. The control values in this column are always blue.

What follows is an explanation of what each processing control is called, what it does, and if applicable, what its audible effect is.

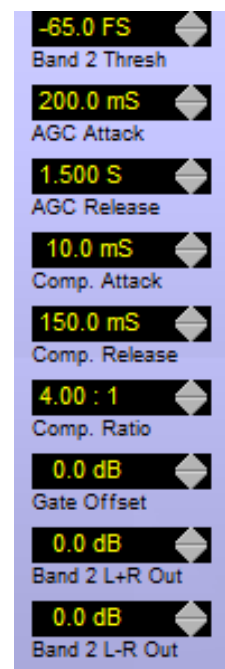

Threshold

The first adjustment in each column is the Threshold (Thresh) control. This control sets the level at which the AGC will start working (or processing) the audio. If the AGC is defeated, then this control will govern the behavior of the compressor.

Like many other controls, the Threshold control is calibrated in dBFS. And, like the Gate Threshold discussed previously, the Threshold control operates with a peak program reference level of -20dBFS. What this means is that if the onset of AGC gain control action should begin 20dB below average program level (to achieve 20dB of average compression), this control should be set 20dB below the internal reference level, or at -40dBFS.

AGC Attack/Release

The next two adjustments in the column control the speed of the AGC. The AGC Attack setting controls how fast the AGC adapts to increases in audio levels. The range of the AGC Attack control is 50-500ms.

Conversely, the AGC Release control setting controls how fast the AGC responds to decreases in audio level. The range of the Release control is 1000-7000ms (1 second to 7 seconds).

Recommending “perfect” settings for the AGC Attack and Release controls is difficult because of how highly subjective the resulting processing will be. What this means is that the settings are highly dependent on many factors including the desired density of processing and its audibility. In general, slower settings in both controls create less noticeable AGC action while faster settings cause the audibility of processing to increase.

If we were to recommend starting points for the AGC Attack and Release we would specify around 300 ms for Attack and 4000ms (4 seconds) for Release. While the range of the AGC Attack controls could achieve a 50ms Attack and 1000ms Release, we do not suggest using AGC Attack times faster than about 150ms and Release times faster than about 2000ms IF all parts of the processor are enabled (AGC, Compressor, Limiter, etc.).

Compressor Attack/Release

These next two adjustments control the timing of the Compressor. Unlike the AGC however, the Compressor is designed to work primarily on short term dynamics and therefore helps to not only build density, but it allows the limiters upstream to not work so hard on the audio coming out of the AGC/Compressor stage.

The Compressor Attack (Comp. Attack) control range is adjustable between 3ms and 100ms. Compressor Release (Comp. Release) is adjustable between 50 and 1000ms (1 second). The ranges of the Compressor controls have been limited to what we feel are the most useful settings and they cannot be set to sound bad. That said, we recommend Compressor Attack settings of between 3ms and 20ms and Compressor Release settings around 300ms. These settings may need to be modified to work better in concert with other controls later downstream.

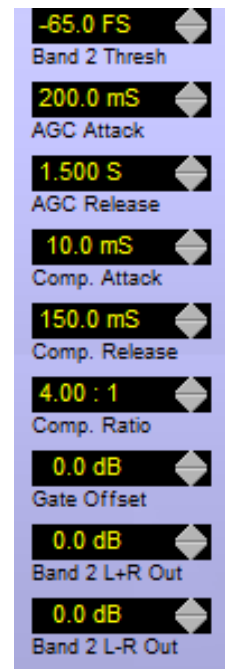

Compressor Ratio

The Compression Ratio (Comp. Ratio) control adjusts how much the audio output level is allowed to increase as the input level increases. A Compression Ratio of 1:1 would make output level changes be a mirror image of the input, i.e., there would be no processing. Likewise a Compression Ratio of 20:1 would allow the output level to only increase by 1dB even though the input level increased by 20dB (a 10:1 change).

The “correct” setting of the Compression Ratio control is highly subjective, just like many other controls in any audio processor. However, our experience is that a Compression Ratio setting of between 2:1 and 6:1 is the most useful, with a setting halfway between (at 4:1) a good all around tradeoff.

Higher Compression Ratios will sound tighter and more squashed while lower Compression Ratios will sound more free and dynamic. The user is completely free to use whatever Compression Ratio he feels sounds best in his application.

It would not be uncommon to see different Compression Ratio settings for each processing band, although that is never a requirement. Our recommendation is to pick a number, say 4:1, and set all bands to that Compression Ratio. Then after adjusting the other controls for the desired density and impact, make small adjustments to the ratios as needed to tame a particular issue. Let us provide an example of when the Compression Ratio is the right knob to grab:

Suppose the Aura1ip is running in its 3 Band mode and everything is sounding really good but you notice that sometimes the high end isn't quite controlled enough on some material. The best way to even things out would be to slightly increase the Compression Ratio for Band 3, and only band 3. Suppose you look at the Compression Ratio setting for that band and see that it is set to 4:1. Try setting it a bit higher, to perhaps 4.4:1 and then listen for a while. If there is too much control, reduce the ratio a little and listen again. If it's not controlled enough, nudge it up a little and listen again.

Again, the ears are always the best judge of the correct settings to use. The best advice that we, as processing experts, can offer an end user about audio processing is this:

**Regardless of what the controls and the meters might say,
if it sounds right, then it IS right!
Stop adjusting!**

Gate Offset

The Gate Offset applies a Gate Threshold offset to each band – an offset of whatever the master Gate Thresh is as applied in the first column.

The purpose of the Gate Offset controls is to allow the precise gating thresholds for each band to be different from the master setting by a specified amount. The amount of available offset is +/-6dB. The best way to explain how the Gate Offset controls work is by example:

Suppose the master Gate Threshold is set to -48dB and everything seems fine except that sometimes Band 3 seems to be gating too late. This can be remedied by adjusting the Band 3 Gate Offset to a setting that is “higher” than 0dB, such as +3dB, which would then set the Band 3 Gate Threshold to -45dB (-48dB plus 3dB = -45dB). This adjustment will have raised the effective Gate Threshold for Band 3, making its gate operate sooner.

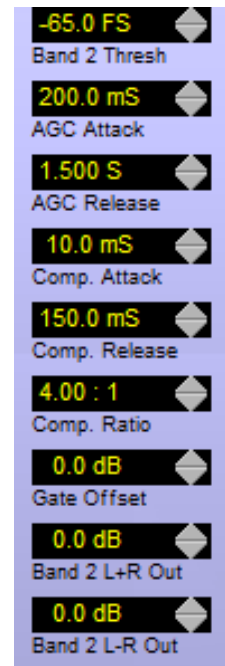

At first glance the Gate Offset controls may not seem to have much range, but remember that -6dB is half and +6dB is twice whatever the 0dB gating level is.

Processing Band L+R and L-R Outputs (L+R Out, L-R Out)

Each processing band has a pair of output level controls (L+R Out, L-R Out) that serve as mix controls allowing the processing's output spectral mix to be adjusted to taste. Both pairs of Output controls have a +/-6dB range. The L-R Output controls, because they are a special case, are also equipped with a MONO position (to be covered shortly).



The L+R and L-R Output controls feed the input to the following multiband limiter (if enabled) so some care must be taken in adjusting the mix controls in order to feed the multiband limiter an appropriate signal. We recommend staying within a +/-3dB range when setting the L+R Output mix controls.

As mentioned previously the L-R Output controls are a special case. The Aura1IP AGC/Compressors operate in the sum and difference domain (L+R/L-R). What this means is that the mono part of the signal (L+R) and the stereo parts of the signal (L-R) are processed independently. Doing it this way permits useful audio enhancements that cannot be accomplished in processors that operate strictly in the Left/Right domain, as most do.

In the Aura1IP the L-R Output control adjusts the stereo part of the audio signal (its depth, width, and spectral balance) without affecting the mono, or “dead center” part (such as live voice). This permits very unique sonic signatures to be created that cannot be achieved any other way.

Because there is an L-R Output mix control for each band, certain parts of the audio spectrum may have their stereo width and depth enhanced (or reduced) independently of the other bands.



The L-R Output controls also have a MONO position. When a band's L-R Output control is set to MONO, there is no L-R stereo width or depth signal added by that band. A popular use of this feature is to remove subsonic “mud” from the stereo difference signal. Bass energy in most contemporary music has equal amplitude, in-phase components in the left and right channels, so any L-R signal that might creep into the low frequencies is probably not bass at all, but noise or other undesired signals. By setting the Band 1 L-R Output (L-R Out) control to MONO, extraneous signals that might otherwise have contaminated the bass frequencies are eliminated.

The setting of the L-R Output controls also adjusts the amount of stereo enhancement present in the output mix. Adjusting the L-R Output controls to positive numbers increases the amount of stereo separation for frequencies contained in the bands whose controls are set above 0dB. A useful setting of the L-R Output controls for tasteful stereo enhancement would be Band 1 = 0dB, Band 2 = +3dB, Band 3 = +1.5dB. Of course reducing these controls has the opposite effect, reducing stereo separation.

Makeup Gain



All of Aura1ip's processing is accomplished by feed-forward control algorithms. Feed-forward control has the advantage that it doesn't rely on errors in the compressor's output signals (as do feed-back algorithms) in order to dynamically control the gain. Rather than measuring mistakes in the output level and then trying to correct them by a (now very late) control signal, feed-forward control prevents errors in the output signal by carefully measuring changes in the input signal's levels and then calculating the precise amount of gain control needed to achieve the perfect output.

Because the compressor's output levels are controlled by changes in the input levels, when the input levels go up, the compressor will push the output level down by whatever amount of gain reduction is called for. This causes the output levels of feed-forward compressors to need to be "made up" after processing, and this is accomplished with a control called Makeup Gain.

The amount of Makeup Gain needed is a function of how much gain reduction was called for due to an increase in input level. In our design we leave around 6dB of additional headroom to accommodate the compressor attack times and such, so if 20dB of gain reduction is being done by a band's AGC/Compressor, then the correct amount of Makeup Gain will be 20dB plus that 6dB, or around +26dB.

The less gain reduction being called for, the less Makeup Gain that is required to bring the signal back up to normal levels afterwards.

Those who may be concerned about "... adding gain after AGC/Compression because it will increase noise..." need to know that the signal processing chain inside Aura1ip has 144dB of dynamic range. This is approximately 50dB more dynamic range than a digital CD. Therefore "noise" is of no concern whatsoever – the processing chain will remain absolutely dead quiet regardless of the amount of Makeup Gain that may be required.

Note also that the amount of Makeup Gain is somewhat dependent on the Compression Ratios being applied to the signals in each processing band. The higher the Compression Ratio, the tighter the output level is regulated, and therefore the more Makeup Gain that will be required. However, the difference in the Makeup Gain required with 20dB of compression at a 4:1 ratio and that required at 20dB compression with a 10:1 ratio is only around 3dB.

Parametric EQ

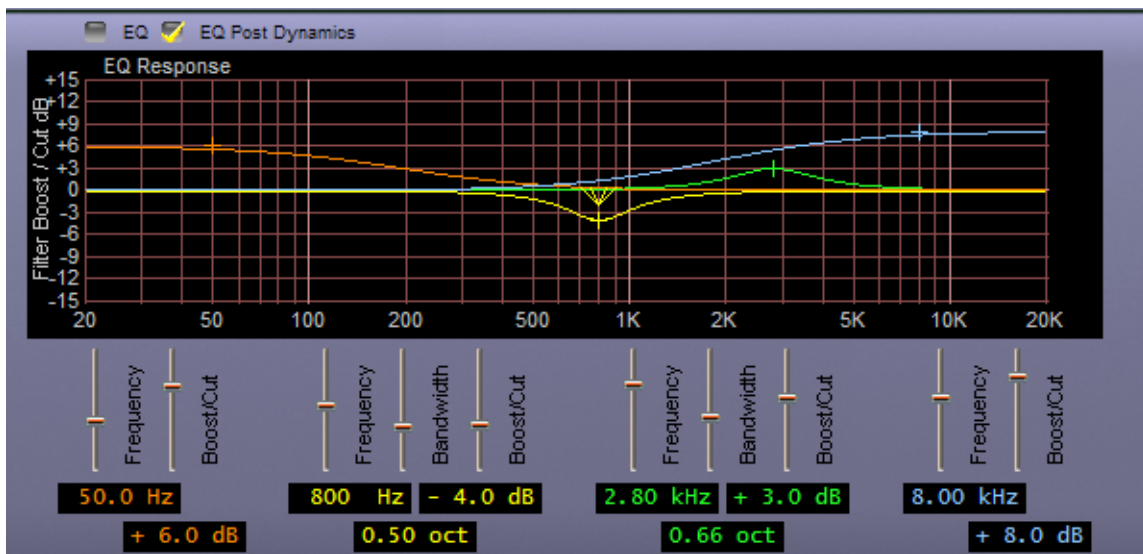

The Aura 1 ip is equipped with a flexible equalizer section which may be used to sweeten the spectral balance. The equalizer provides a graphical representation of the equalizer's contribution to the audio by creating shaded areas in the graph representing the mathematical result of overlapping equalizer sections.



The equalizer may be placed before or after the AGC/Compressor stage, and though the audible effects of each placement are different (and sometimes subtle) they are important to understand. We will discuss this shortly.

The equalizer has two parametric sections (adjustable frequency, boost/cut, and Q) and two shelving filters (adjustable frequency and boost/cut). The shelving filters behave somewhat like tone controls on consumer audio equipment, and provide a broad, low-Q boost or cut at the extremes of the audio spectrum.

The two parametric sections provide a broad or narrow boost or cut to any frequency within the 20Hz to 20kHz audio spectrum, and may even overlap to create special EQ curves.

Equalizer Band 1 provides a shelving response of +/-14dB and may be tuned between 20Hz and 198Hz.

Equalizer Bands 2 and 3 have a parametric response and may be tuned anywhere within the 20Hz to 20kHz audio band, providing up to 14dB of boost or cut and at bandwidths (Q) of between 0.20 and 3.0 octaves.

Equalizer Band 4 provides a shelving response of +/-14dB and may be tuned between 2.0 kHz and 20 kHz.

As mentioned earlier, the equalizer section may be placed before or after the AGC/Compressor. Placing it before “preloads” the AGC and allows any tonal adjustments to be managed by the AGC/Compressor. This, for instance, allows the adding in of more bass or high end without fear of overloading the following multiband limiter on some program material because the AGC/Compressor will see this extra energy and try to manage it.

On the other hand, placing the equalizer after the AGC/Compressor can sound more dramatic because any equalization is no longer managed by the AGC/Compressor (which helps to tame it somewhat) but is instead managed by the multiband limiter which typically is doing very little gain management.

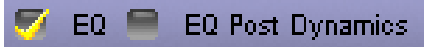

The correct placement for the equalizer is both highly subjective and highly dependent upon the particular application. For most applications we recommend operating

with the “EQ Post Dynamics” box unchecked. There are three ways to adjust the EQ:

1. The sliders below the graphical area may be used to adjust the frequency, boost or cut and the bandwidth (Q, if available) in the band of interest;
2. The value displays under the controls can be double-clicked which opens an entry dialog where the desired values can be manually entered from the keyboard;
3. The equalization curves themselves may be dragged with a mouse to the desired settings.

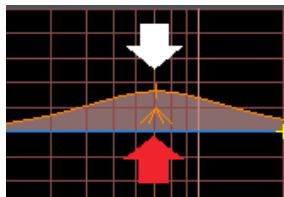

When manually dragging the curves there are three control behaviors to be aware of. The first two pertain to the “+” at the center of the curve which can be dragged left to right to set the desired equalizer frequency and up and down to set the desired boost or cut.

The third control is available only in the two parametric sections and it is represented by the tent symbol underneath the curve. Placing the mouse cursor on this symbol and then dragging left or right adjusts the Q (bandwidth) of the equalizer section.

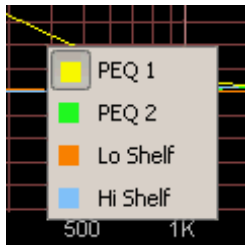

If it seems that a curve isn’t responding to mouse input, right click on the graphical area to bring up the dialog shown at left and select the curve that you wish to adjust.

When the equalizer section is enabled the audio spectrum being influenced by the equalization is represented by shaded areas of the audio spectrum. To show what we mean, please refer to the next graphic.

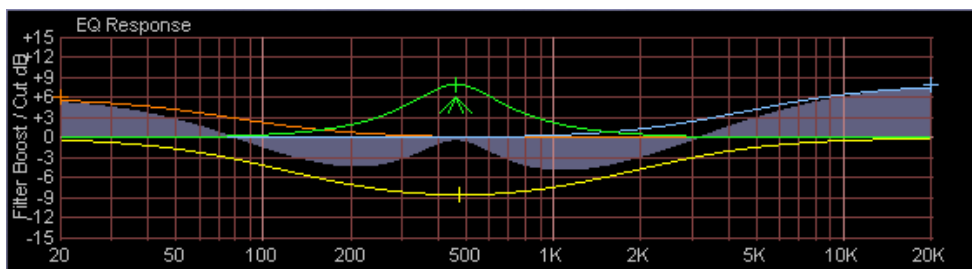

Here we’ve created a bizarre (for example only!) curve to show how the shaded areas represent the mathematical effects of the applied equalization. We’ve added low and high frequency shelving to boost the signals at the extremes of the audio spectrum. We’ve also used the two parametric equalizers in an overlapping fashion to create two scooped out

areas of the midrange. Note how the yellow curve (bottom) is very broad – this is applying a very broad dip in the frequency response between about 100Hz and 3kHz. However, notice that the green curve (top) is set to be rather narrow – much narrower than the yellow curve on the bottom. The combined effect is a broad reduction in frequencies between 100Hz and 350Hz and between 600Hz and 2.5kHz.

A Word About Our Limiters

Vorsis has returned the limiter to its rightful place as a device that only reacts to control a peak in the audio level and only to the degree necessary to control that peak. These limiters are not intended to be used to add their own signature to the audio; they are there merely to prevent audio from exceeding a predetermined peak level.

In more conventional designs the limiters are sometimes found to be equipped with gates, return to zero functions, temporary holds and even interband coupling. These limiters typically need these functions to make up for deficiencies in the preceding AGC or compressor – the limiters then act as a second, faster compressor to build density while, at the same time, are also tasked with controlling peaks. Conversely, Vorsis designs utilize much better AGC and Compressor algorithms that allow the following limiter to be just that, a limiter.

Unless the limiters have been tuned to create a very specific effect, there should normally be no more than 3dB of average gain reduction seen. At times, there may not be any activity at all in a limiter band, however rest assured that the limiters ARE working properly, they just don't need gating and 12dB of gain reduction to do it!

Multiband Limiter



Before we begin discussing the multiband limiter it is important to recognize that the number of limiter bands is controlled by the number of AGC/Compressor bands as selected by the *Number of Bands* control discussed in the AGC/Compressor section of this manual. Further, if

the number of bands control has been set to Broadband, we recommend not enabling the remaining band of the multiband limiter – this work is better done by the final limiter. In fact it will be obvious from our presets that all Broadband factory presets defeat this limiter.

There are four adjustments for each limiter band:

Threshold (Band x Thresh)

This control has a range of -6dB to +6dB and sets the level at which LIMITING will commence. At 0dB the limiter acts more as a protective device to prevent peaks from getting above 0dB. Set to negative numbers the limiters begins to work sooner and therefore limits the audio to below 0dB. Set this way the limiter is not only preventing peaks, it is also imparting its own signature on the sound. When set to positive numbers, and if the gain structure of the processing prior to the limiters is correct, the limiter will still be awake but will rarely, if ever, introduce gain reduction.

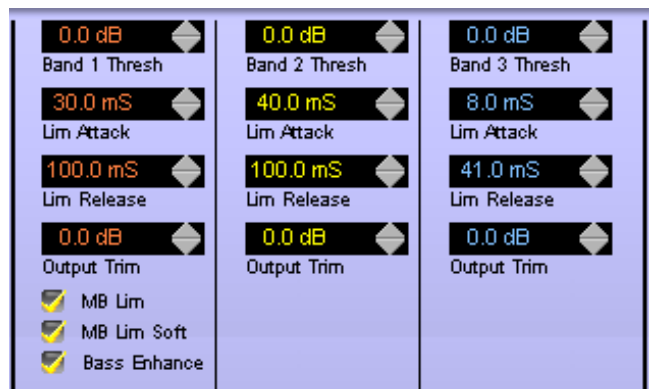

Limiter Attack (Lim Attack)

This controls how rapidly the limiter will act to control audio peaks. We made the range of this control 0.3ms to 100ms; however, we recommend operating with settings between 0.3 and 10ms. With settings slower than this, peak control will be sloppier, and though the multiband limiter attack setting isn't critical, slowish attack times will make the final peak limiter work harder.

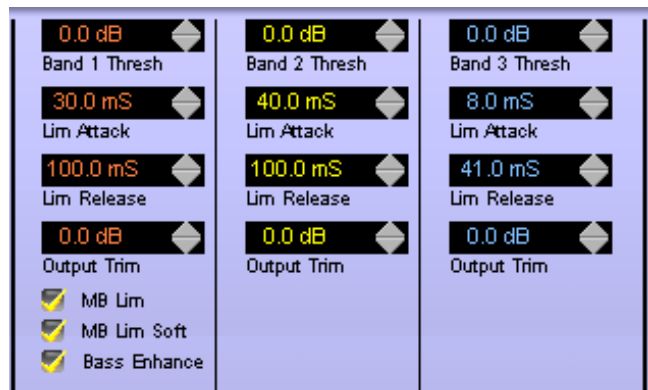

Limiter Release (Lim Release)

This control sets how quickly the limiter recovers once a peak has passed and the audio level falls below the limit threshold. The adjustment range of this control is 3ms to 100ms.

Very fast release times (under 30ms and especially in the low band) coupled by very fast attack times (under 5ms) will yield a tightly controlled audio signal that has a “radio” sound. Very slow release times (greater than 50ms) will yield a more open sound that is still well controlled (relative to the attack time settings). As we have said with the AGC/Compressors, unless you are very familiar with these types of controls, it's probably best to not wander too far from the settings in the factory presets.

Output Trim

Each limiter band is followed by its own Output Level mix control which can be used to make fine adjustments to the final tonal balance. Because the setting of these controls can be fairly touchy, we recommend leaving them at 0dB unless a specific sonic effect is desired.

Multiband Limiter Options

The multiband limiter is equipped with two other operating modes besides simply on and off. On and Off is controlled by the check box labeled **MB Lim**. The other two options require some explanation.

MB Lim Soft – Checking this box enables a small amount of anticipation in the limiter behavior, causing it to start to limit approximately 2dB below the absolute limit threshold as set by the Band x Thresh control. This anticipation serves to soften the limiter action by making it “spongy.” That is, it will ooze in and out of limiting in a softer fashion which makes it quite effective (and good sounding) in voice applications.

Bass Enhance – This check box enables a Vorsiis-proprietary algorithm which enhances low bass without creating intermodulation distortion or muddiness. It enhances the sound of bass when heard on small, bass shy speakers and adds richness to the sound without adding noticeable distortion.

Look Ahead Final Peak Limiter

The final section of processing is the Lookahead Limiter with its defeatable lookahead function. In studio applications, the final limiter can probably be defeated. However, if the audio destination is a method of transmission (STL, audio stream, uplink) with a defined maximum peak input level, or if you want to recreate a “radio” sensation for talent headphones, using this limiter is a good idea.

Final Lim. Drive

This control sets the drive level for the final peak limiter. The preferred way to set this control is to adjust the Final Lim. Drive until there is 1dB to 3dB of indicated limiting on the final limiter meter.

Attack

This control sets how quickly the limiter will react to audio peaks. While the range for this control is 0.2 to 30ms, we recommend a setting between 0.2 and 10ms. Anything slower than 10ms will not yield effective peak control.

Release

This control sets how quickly the limiter will recover after reacting to an audio peak and after the level drops. The range of this control is 33ms to 330ms, with a recommended setting of around 180ms.

Delayed Release Control

This control sets the amount of delayed or secondary release for the limiter. When Delayed Release is engaged (see below) the first 3dB of gain reduction is released at the Release Time setting and the remainder occurs at the speed set by the Delayed Release control. The purpose of delayed release is to reduce or prevent intermodulation distortion when very fast limiter release times are being used. Delayed Release also helps to reduce pumping artifacts by preventing the limiter from making a full gain recovery during syllabic changes in audio level.

Look Ahead Limiter Special Option Check Boxes

Final Limiter – When this box is checked the final limiter is engaged and its operation is governed by the final limiter operating adjustments. When this box is not checked the final limiter is disabled and no final peak control is in effect.

Delayed Release – When this box is checked the final limiter is utilizing the Delayed Release algorithm as governed by the Delayed Release control setting as explained earlier. When this box is not checked, only the primary Release time algorithm is in effect.

Look Ahead – When this box is checked a small amount of lookahead is applied to the final limiter, allowing it to react to an upcoming audio peak just as it arrives at the limiter input. Lookahead allows the limiter to anticipate peaks and adapt to them early enough that output level overshoots due to non-zero attack time are prevented. We recommend using the Lookahead option whenever signal path latency is NOT an issue. If latency is an issue, this option should not be checked (lookahead is then bypassed).

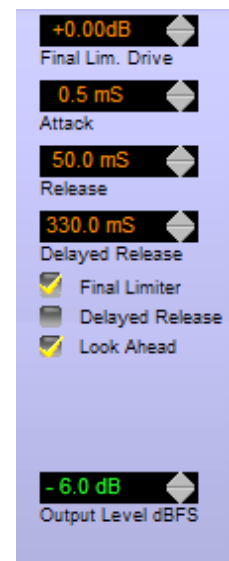

Output Control (Output Level dBFS)

The output level control sets the absolute peak output level within the range of -39.5dBFS to 0dBFS. If the control is set below -39.5dBFS the audio is muted (OFF). Remember that there is no more processing available after this stage so some care is required in setting the Output Level if peak headroom is a concern in your application.



Metering Discussion

Input Metering

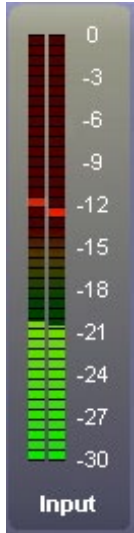

All metering in the Aura1ip is sample-accurate, true peak reading, including the gain reduction meters. The Input and Output meters are calibrated in dBFS so that an accurate determination of these levels may be made. The recommended input level operating range is between -18dBFS and -12dBFS. Care should be taken to ensure that the input peak level never exceeds -9dBFS, especially if the Phase Rotator is enabled. This is because clipped waveforms exit any phase rotator at much higher peak levels because the phase rotator upsets the signal's harmonics. It is not uncommon to see clipped waveforms exit a phase rotator with an increase of 12dB in peak levels!

In conventional VU and average responding meters, **0dB** (or 0 VU) usually indicates the desired average operating level. On the other hand, the metering within the Aura1ip follows standard operating practice for digital signals and provides an accurate indication for when **0dBFS** is reached. If and when signal peaks reach 0dBFS, there are no more digital bits available to define the audio signal, which results in hard clipping and severe distortion. The Input meter shown at left is indicating good input levels – peaks are at, but not above, -12dBFS – good operating practice.

Gain Reduction Meters

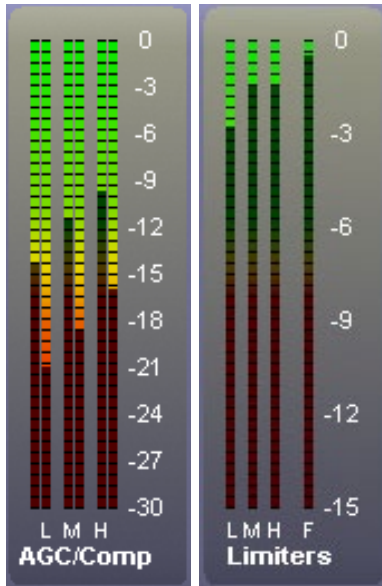

Multiband AGC/Compressor and Limiter – The AGC/Compressor gain reduction meters display the amount of processing in each band, and for both the slower AGC, and faster Compressor.

The gain reduction meters for the multiband limiters look similar to the meters for the AGC/Compressor, but have reduced scales more appropriate for limiters.

Metering for each band follows the L, M, H (Low, Medium and High) convention, and the left meter is for AGC and right for Compressor.

Final Look Ahead Limiter Metering – The right-most meter scale within the group of multiband limiter meters is for the final lookahead limiter. This meter should rarely show more than 2dB to 3dB of activity.

Normal Gain Reduction – The following is a general guideline for what normal indications might be:

Meter	Minimum Reading	Maximum Reading
Multiband AGC	3dB	24dB
Multiband Limiter	0dB	6dB
Final Limiter	0dB	3dB

Output Metering

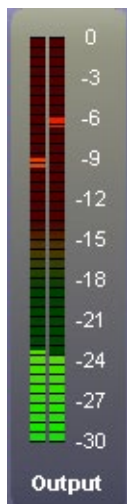

Like the Input metering, the Output metering is sample-accurate, peak reading, and is calibrated in dBFS. By observing the difference between the consistency of the Input and Output levels the effects of processing are readily apparent.

Note also that because the Output Meters are reading the peak levels of audio which has been processed and probably also peak limited, there is no maximum level constraint like there is on the Input side of the processor. In other words, the effects of processing have made the maximum peak levels ‘known’ and therefore the Output meters may safely indicate all the way up to 0dBFS.

While a 0dBFS output level is certainly possible, it may not be practical from the standpoint that we do not know what the behavior of the device following the Aura1ip is going to be, and whether it has enough headroom. Our experience is that it is safe to set the digital output levels up to around -3dBFS without incurring any unexpected distortion or other issue in the equipment coming afterwards.

One additional thought about Output levels, if we may ... when feeding audio codecs it is best to keep their maximum Input level at -3dBFS or even slightly lower. The reason for this is that when the codec removes energy from the audio (which it must do in order to encode the audio) the peak audio levels inside the codec algorithm increase because information has been removed, information that was required in order to maintain the original peak levels. Now, the designers of the codec may have accounted for this effect, or they may not. We do not know for sure. Therefore the best thing to do is run the codec’s input levels a little on the light side, perhaps between -6dBFS and -3dBFS, just to be safe.

Sidebar Region

To the right of the OUTPUT METERING column is a vertical row of seven special buttons. Each button has been designed as an entry point into a dialog designed to help the end user get the most functionality out of the product.

Preset

When this button is left-clicked, a Windows style dialog opens. The Pro GUI must be online to the processor for the window to display the list of presets installed on the Aura1ip hardware.

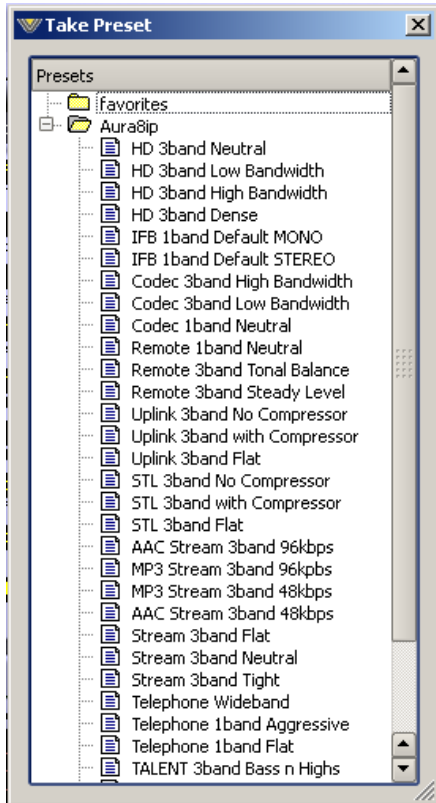

The folder called **Aura1ip** represents the hardware itself and the presets stored there. Other folders, **favorites**, **Factory Presets**, etc. can only be seen within the Library dialog, covered later.

Here, the presets stored on the hardware itself are visible, and any preset may be selected and placed into use by simply double-clicking on it.

In order to save a preset, simply press the **SAVE** button to open a Windows-style file save dialog.

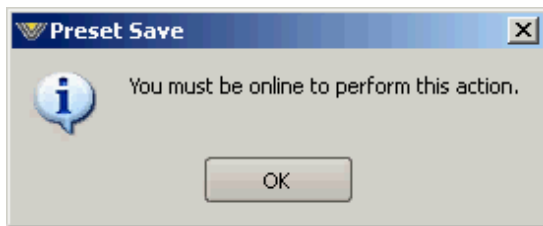
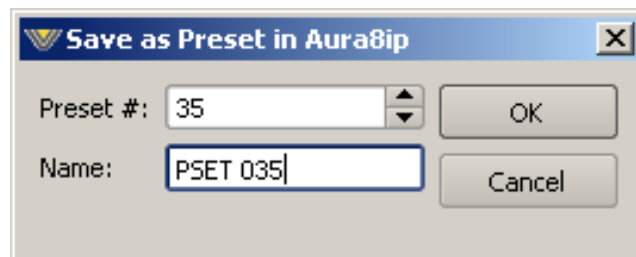

Note that the Pro GUI must be online to the processor in order for presets to be saved. If the Pro GUI is not online and the Save button is pressed, a warning dialog will appear.

It is important to remember to save any preset deemed important before taking another because any unsaved settings will be lost once the new preset is loaded. There is no warning dialog!

When saving a preset, and unless selected otherwise, the preset will be saved into the next available empty slot on the hardware.

Alternatively, by nudging the preset number (“PRESET #”) up or down, a preset may be saved in any preset location except one that has been locked. If a preset is saved into an unlocked location where a preset already exists, that preset will be overwritten with the new preset!



Locking Presets – Presets that have been stored within the processor hardware may be locked by the user to prevent inadvertent overwriting, renaming, or deletion. This is accomplished by opening the Preset Library by clicking on the Library button in the Pro GUI. Once the list of presets is open, the presets stored on the processor hardware are visible in the left pane.

There are two ways to manage the lock status of user presets:

- The first method is by highlighting a preset (single left click) and then right clicking it to open a dialog box. Among the options are Lock Preset and Unlock Preset.
- The second method is by highlighting a preset as above, and then clicking the Edit option at the top of the Preset Library dialog box to reveal the Lock Preset/Unlock Preset options.

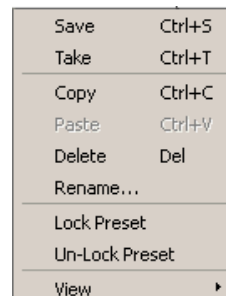

Note that these are user-level preset lock options and do not override the lock status of a preset that has been factory-locked!

Library

When the Library button is clicked a three panel Windows-like dialog will appear.

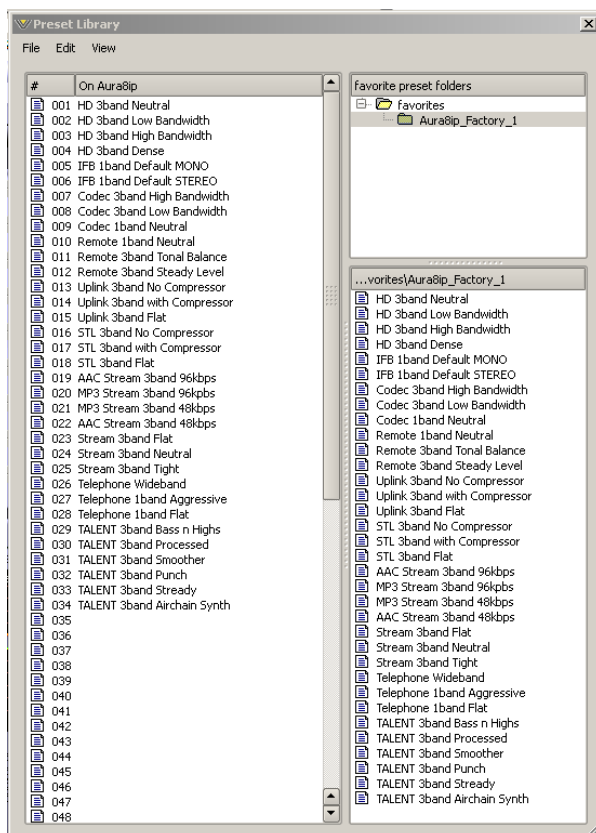

This dialog is divided down the center, and each side has a special purpose. The left hand side will display all of the presets currently stored on the hardware, and the right hand side shows the folders and presets currently stored on the user's PC where the Pro GUI has been installed.

Simple Windows-style drag and drop mouse actions are utilized when moving presets back and forth between the PC and the hardware



Note that if the Pro GUI is not online to the hardware, no presets will appear in the left hand pane simply because when the Pro GUI is not online it has no way to retrieve the list.

The Library dialog is also the place where presets can be added and deleted from the PC or the hardware, or if desired, presets can even be locked on the hardware to prevent inadvertent changes or deletions.

Devices

Clicking on the Devices button opens up a list of Aura1ip devices known to the Pro GUI. To connect to any Aura1ip processor, it must first be selected in the device dialog before the Pro GUI will attempt to go online to it. By highlighting the desired Aura1ip's name and hitting *Select*, the Pro GUI will then know that that is the unit you wish to connect to the next time you press the Pro GUI's Online button.

If the Pro GUI was already online to another device at the time a new device is selected within the Devices dialog, the Pro GUI will immediately try to connect to the new device as soon as the Select button has been pressed.

The first time the Device dialog is opened, no devices will be shown. Before the Pro GUI can connect to **any** Aura1ip the unit must first be made known to the Pro GUI by using the Add Device dialog.

When the Add Device dialog is opened there is an opportunity to provide a custom name for the Aura1ip, and this name will be shown in the Device window at the top of the Pro GUI. Once the IP Address of the Aura1ip has been entered the Select button should be pressed if that is the processor you wish to connect to. Or, if you are just adding a device for later, click the OK button to close the dialog.



Quick Save (QSave)

The Aura1ip has a unique feature called QSave which allows the instant comparison of two different sets of processing tuning settings. It can also be used to compare the sound of a Factory preset to the modifications being made by a user without having to first save the user preset.

The QSave A and QSave B buttons are assigned to two temporary buffers inside the Aura1ip that hold all current processing settings as long as power is applied to the unit. While QSave A is highlighted green any adjustments that you make to the controls are being saved to that temporary buffer. QSave B is another temporary buffer that operates just like QSave A. When a QSave button is active its green indicator is illuminated.

Though there are several ways to use the QSave feature, one popular way is to compare the sound of a factory preset to changes made to that preset by a user without having to first save it as a user preset. To do this, follow these steps:

1. Recall the factory or user preset that you wish to adjust.
2. Ensure that QSave A is highlighted. If it is not, press its button to highlight it.
3. Press the B=A button. This will copy the contents of QSave buffer A to QSave buffer B. Now the contents of both buffers are identical.
4. Change some settings on the Aura1ip. These settings will automatically be stored in the QSave A buffer.
5. Compare your changed settings to the recalled factory preset by pressing the QSave B button.
6. Compare those settings back to the factory preset by pressing QSave A.
7. When you are happy with your changes you can commit them to a user preset by using the Save preset dialog that was covered previously.

The QSave A and QSave B buttons may also be used to compare the sound of two different sets of user settings. To do this:

1. Load the preset that you want to change, then make changes to it and press QSave A to save those settings to buffer QSave A.
2. Make additional changes as desired and then press QSave B to save those additional changes to buffer QSave B.
3. Now you can compare the two sets of settings by toggling back and forth between the QSave A and QSave B buttons.
4. When you are pleased with one set of settings and need more buffers for further tweaking, you can use the A=B/B=A button to make the two buffers the same and have one of them to use to start comparing from again.

Title Bar Region



As was hinted at in the section of the manual pertaining to configuring and selecting devices, the Aura1ip Pro GUI is capable of controlling hundreds of Aura1ip units on the same connected network.

Along the top edge of the Aura1ip Pro GUI screen and between the “Vorsis Aura1ip Pro” product label on the left and the Windows About/Minimize/Exit icons on the right are four status indicators and controls for the management of devices and presets.



The first is a small button with embedded green indicator. This button is used to put the Pro GUI online to an Aura1ip device. When the indicator is green the Pro GUI is connected to, and is controlling, the selected Aura1ip device.

Status

When a connection is attempted, made, or disconnected the Status window will display the status of this action. When the display indicates Offline no connection to an Aura1ip device is being attempted.

When the Status window indicates Trying the Pro GUI is in the process of establishing a connection to a remote Aura1ip device. As long as the status is Trying the device has been found but full communications has not been established.

When the Status window indicates Online, the Pro GUI is in command of the connected device.

Devices

This window indicates what device has been selected for control from within the Devices dialog covered earlier. If no device is displayed, or if it indicates “Unknown” then no device has been configured or selected in the Devices dialog.

Presets

This window shows the currently running processing preset. If the text is displayed in green, all parameters that were originally saved with the preset are still active and no changes have been made to any of the settings. If the text is displayed in orange, then one or more parameters in the current preset has been modified and the new settings have NOT yet been saved as a new preset. If the text is displayed in orange and a new preset is taken, any changes preset in the previous preset are lost forever. This may or may not be the desired action – be careful!

Accessing Menu Option

Right clicking anywhere on the Aura1ip Control Panel will open a pop up menu tree with access to the File, Hardware, and Presets choices. These choices then lead to sub-menus and dialog boxes that may also be accessed by clicking on other dedicated buttons on the main Aura1ip control panel.

As with many Windows programs, there are multiple ways to access the menu trees – please feel free to go ahead and explore.

File Menu Items

About – Brings up the About box to indicate the Pro GUI software version.

Choose Skin – Brings up the Choose Skin dialog box. Skins in Wheatstone processors are Pro GUI overlays which alter the look of the Pro GUI. It could be color, shape, or other aspects of the Pro GUI which change when skins are changed.

Exit – Closes the entire Pro GUI (not just the dialog window).

Hardware Menu Items

The Hardware menu tree may be accessed by right clicking anywhere on the main Aura1ip Control Panel. Please note that most of the hardware-related items cannot be reported unless the Pro GUI is online to the hardware (this is where the data must come from!).

Sub menu choices include:

Devices... – Opens the Devices dialog box which allows the creation, editing, selection, and deletion of Wheatstone processor devices that are known to the Pro GUI.

On-Line Mode... – Toggles between ONLINE and OFFLINE modes. In offline mode the Pro GUI is not connected to the processor but can still take presets and have their settings viewed.

Login Password... – Opens the Passwords dialog box for creating and editing login passwords.

Version... – Displays the current software and firmware versions that are installed and running on the Aura1ip hardware, noting that the only time you can view the hardware versions from the Pro GUI is if it is actually connected and online to the hardware.

Presets Menu Items

The Presets menu tree may be accessed by right clicking anywhere on the main Aura1ip Control Panel.

Take... – Performs the same action as clicking the Preset button.

Save... – Performs the same action as clicking the Save button.

Library... – Performs the same action as clicking the Library button.

Appendices

Appendix 1

Configuring Control Surfaces for Use in WheatNet-IP Systems A-7

Appendix 2

Cisco 2960G, 2960S, and 2960X Configuration for WheatNet-IP.A-14

Overview.....	A-14
Privileged EXEC Mode	A-15
Global Configuration Mode	A-15
Configuring the VLAN Interface.....	A-15
IGMP Snooping Querier Configuration	A-16
Configuring Gigabit Ports Connecting to WheatNet-IP I/O BLADE3s and PC Drivers	A-16
Configuring Gigabit Ports Connecting to WheatNet-IP Control Surfaces, GP Panels, and XY Controllers.....	A-17
Configuring Ports for Linking to Other Network Switches	A-18
Checking and Saving the Switch Configuration.....	A-18

Cisco 3750G, 3560G, 3650, and 3850 Configuration for WheatNet-IP..A-19

Overview.....	A-19
Privileged EXEC Mode	A-20
Global Configuration Mode	A-20
Configuring the VLAN Interface.....	A-20
IGMP Snooping Querier Configuration	A-21
Configuring Gigabit Ports Connecting to WheatNet-IP I/O BLADE3s and PC Drivers	A-21
Configuring Gigabit Ports Connecting to WheatNet-IP Control Surfaces, GP Panels, and XY Controllers.....	A-22
Configuring Ports for Linking to Other Network Switches	A-23
Checking and Saving the Switch Configuration.....	A-23

HP Procurve 2810 Configuration for WheatNet-IPA-24

Overview.....	A-24
Privileged EXEC Mode	A-25
Global Configuration Level	A-25
Configuring the VLAN Interface.....	A-25
IGMP Querier Configuration.....	A-26

Configuring Gigabit Ports Connecting to WheatNet-IP I/O BLADE3s and PC Drivers	A-26
Configuring Gigabit Port Connecting to WheatNet-IP Navigator PC.....	A-27
Configuring Gigabit Ports Connecting to WheatNet-IP Control Surfaces, GP Panels, and XY Controllers.....	A-27
Configuring Ports for Linking to Other Network Switches	A-27
Checking and Saving the Switch Configuration.....	A-27

Appendix 3

WheatNet-IP Logic Functions and Examples	A-30
Category 1: Direct Logic	A-30
VDip Function.....	A-30
Programmable Buttons	A-33
Category 2: Audio Associated Logic.....	A-38
Category 3: Discrete Logic.....	A-43
Category 4: Action Logic.....	A-47

Appendix 4

External Controllers	A-49
-----------------------------------	-------------

Appendix 5

WheatNet-IP WDM Driver Installation	A-51
Hardware Requirements.....	A-51
Software Requirements.....	A-51
Installation	A-51
Application Note.....	A-54c
Configuration.....	A-55
System Parameters	A-55
Software License.....	A-55
Removing the Drivers	A-57

Appendix 6

IP-MTR64 Meters GUI	A-59
Introduction To IP-MTR64 Meters GUI	A-59
IP-MTR64 Meters GUI Overview	A-59
IP-MTR64 Meters GUI Features.....	A-59
Installation	A-60
Requirements	A-60
Performing The Install	A-60
Adding The IP-MTR64 Meters GUI To The Peripheral Devices Tab.....	A-63
Program Operation - Getting Started.....	A-64
License Key	A-64

First Time Operation.....	A-65
Network Setup	A-65
“Discovering” The System Components.....	A-67
Setting Up Meters	A-69
Configuring A Meter Cell	A-69
Using The Analysis Window	A-70
Changing The Meter Layout.....	A-70
Configuring Silence Detect Alarms	A-71
Security Settings	A-73
Setting The Password	A-73
Operating With Security	A-73
Making The Security Settings	A-73
Menus.....	A-74
View	A-74
Layout.....	A-74
WheatNet-IP System.....	A-74
Setup	A-74
Additional Popup Menus.....	A-75
Summary	A-75

Appendix 7

WheatNet-IP Scheduler	A-78
Introduction To Wheatnet-IP Scheduler	A-78
Events And Signals	A-78
Installation	A-79
Requirements	A-79
Performing The Install	A-79
Uninstalling The Program	A-82
First Time Operation.....	A-82
License Key	A-82
First Time Operation When Connected To A System.....	A-83
When Connection To A BLADE3 Succeeds at Startup.....	A-85
When Connection To A BLADE3 Fails at Startup	A-86
Day To Day Operation	A-87
System	A-87
Set IP Address.....	A-87
Define Devices.....	A-88
Signals.....	A-89
Request Signals From Connected BLADE3	A-89
Load Signals From File.....	A-89
Save Signals To File	A-90

Events.....	A-90
Load Events From File.....	A-90
Save Events To File	A-90
Create Events	A-90
View Events	A-91
Edit Events	A-94
Schedule Events.....	A-95
Delete Events	A-95
Schedule Management	A-96
Moving Items.....	A-96
Deleting Items	A-97
Enabling and Disabling Items.....	A-97
Exiting With A Schedule Running.....	A-98
More On Existing.....	A-98
Logs.....	A-98
Viewing Logs	A-99
Menus.....	A-99
File.....	A-99
Edit	A-100
Events.....	A-100
Schedule	A-100
Signals.....	A-101
Help	A-101
Event Log Menu	A-101
Event Log Menu - File	A-101
Event Log Menu - Edit.....	A-101

Appendix 8

WheatNet-IP PC-XY Software Configuration Guide	A-103
Overview.....	A-103
Installing The Software	A-103
Network Considerations	A-103
Logging In.....	A-104
Menus.....	A-104
Setting BLADE3 IP Address.....	A-104
Using Source / Destination Windows.....	A-105
Logging Out.....	A-105
Visibilities.....	A-105
Hot Button Programming	A-106

Appendix 9

Introduction to Screen Builder.....	A-108
--	--------------

Appendix 10

Introduction to OLED Switch Panels.....	A-111
--	--------------

Appendix 11

WheatNet-IP and AES67.....	A-113
System Requirements.....	A-114
Timing.....	A-114
Packet Structure.....	A-115
Multicast Address Change	A-116
Ports	A-116
Using WNIP with AES67.....	A-117
Example 1: Bringing in audio streams from an Axia xNode using 1/4ms packet timing.....	A-121
Example 2: Bringing in audio streams from an Axia xNode using 1ms packet timing.....	A-125
Example 3: Sending a WNIP audio stream to an Axia xNode using 1/4ms packet timing.....	A-128
Example 4: Sending a WNIP audio stream to an Axia xNode using 1ms packet timing.....	A-131
SDP Files.....	A-133
Summary	A-135
Some Screen Shots of Various Vendors Configuration Screens.....	A-136

Appendix 1

Contents

Configuring Control Surfaces for Use in WheatNet-IP Systems A-7

Configuring Control Surfaces for Use in WheatNet-IP Systems

Wheatstone makes a number of different model control surfaces. Not all of these are compatible with the WheatNet-IP system. Currently supported are the Evolution series (E-1, E-4, E-5, and E-6) and LX-24 control surfaces.

In order to use a control surface with the WheatNet-IP system it must be properly configured. There are two parts to this configuration. First, the control surface must be equipped with the correct version of WheatNet-IP specific software. If you have ordered your control surface as a part of a WheatNet-IP system, this will be taken care of automatically. If you are moving a control surface purchased previously, its software may need to be updated. The Evolution series control surfaces can be used with other Wheatstone products and may be equipped with software specific to other applications. Consult with Wheatstone Technical Support; they can assist you with any required software updates.

The second part of the configuration is to mate a specific control surface to its mixing engine BLADE3 within the WheatNet-IP system. This mate up process is actually done at the control surface itself. To complete this process successfully, the control surface and its intended WheatNet-IP engine must be powered up and connected to the same LAN.

First, be sure that you know the BLADE3 ID and IP address of the intended WheatNet-IP engine BLADE3. This BLADE3 must be available and unassociated with any other control surface. You can confirm this information via the front panel controls on the engine BLADE3, or from the WheatNet-IP Navigator GUI.

At the control surface click on the “Options” tab and then the “Network Settings” menu.

Enter the WheatNet-IP ID and IP address in the boxes provided, and verify that the IP address of the control surface is correct (it must be on the same subnet as the



BLADE3s). While you are at it, it is highly recommended that you use the IP address number convention for the control surface IP address. This convention makes it easier to understand and trouble shoot your system architecture. Simply take the ID number of the engine BLADE 3 and add 200 to it. Thus Engine BLADE3 ID=02 would have IP address 192.168.87.102 and the mating surface would have IP address 192.168.87.202.

Reboot the control surface. After the surface has booted up, the new settings should now be visible in the “Options”/”Network Settings” tab of the control surface VGA display.

Once the control surface has been associated with a WheatNet-IP engine, the BLADE3 will query the surface for its configuration information and then automatically generate the required source and destination signals. A control surface icon (showing its IP address) will be added to the WheatNet-IP Navigator GUI system view, attached to the mating engine BLADE3.

The specific signals created and their default names are a function of the model and size of the associated control surface.

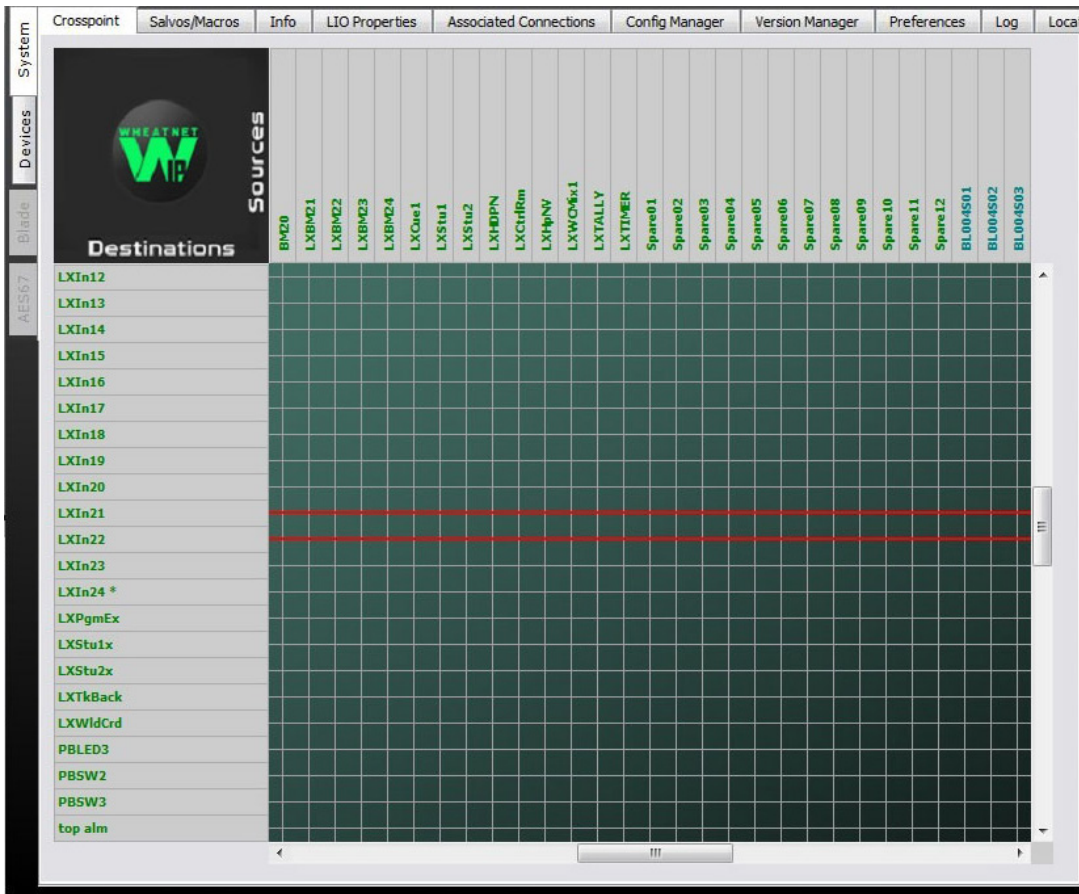
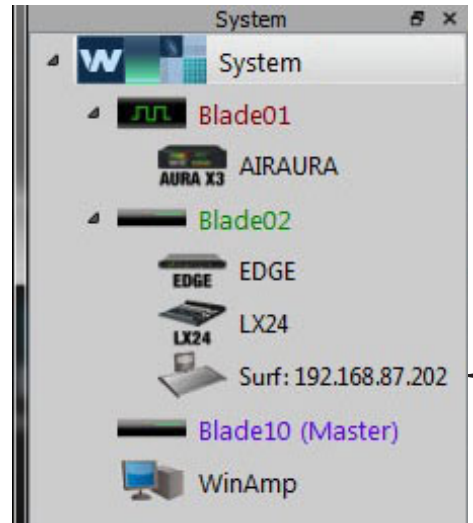

The following is a listing of a typical set of signals for a XX fader LX-24 control surface. Of course, just as with any other signals, you can rename these however you choose; if

you've done so, the names on your system may not exactly match the ones on the following list.

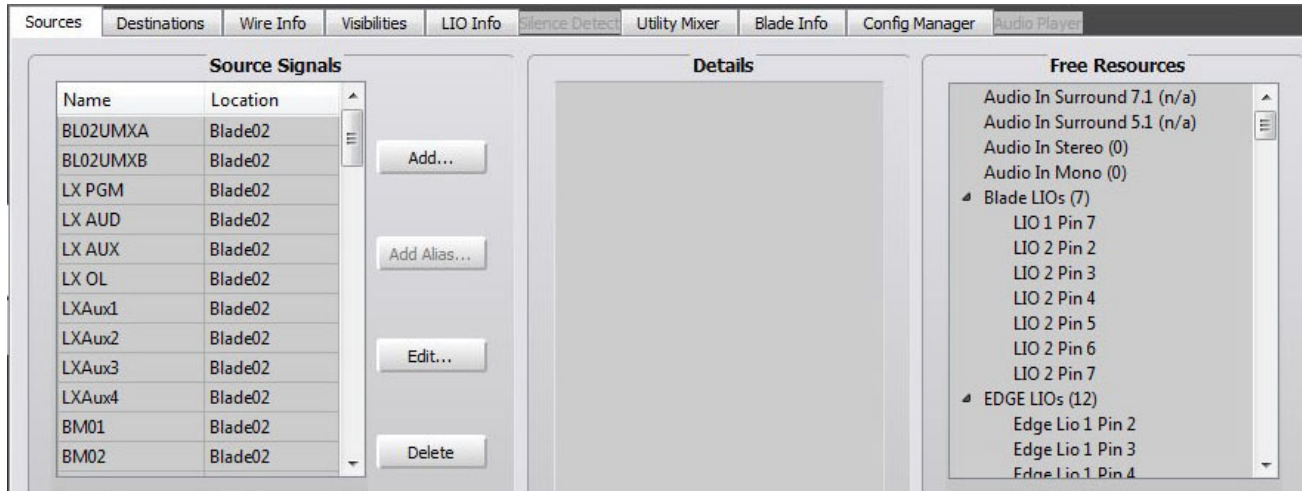

Sources

Spare01	Logic signal associated with programmable button #1
Spare02	Logic signal associated with programmable button #2
Spare03	Logic signal associated with programmable button #3
Spare04	Logic signal associated with programmable button #4
Spare05	Logic signal associated with programmable button #5
Spare06	Logic signal associated with programmable button #6
Spare07	Logic signal associated with programmable button #7
Spare08	Logic signal associated with programmable button #8
Spare09	Logic signal associated with programmable button #9
Spare10	Logic signal associated with programmable button #10
Spare11	Logic signal associated with programmable button #11
Spare12	Logic signal associated with programmable button #12
LXAux1	Aux 1 audio mix
LXAux2	Aux 2 audio mix
LXAux3	Aux 3 audio mix
LXAux4	Aux 4 audio mix
LXBM01	Bus minus 1 audio mix (for fader 1)
LXBM02	Bus minus 2 audio mix (for fader 2)
.....	
LXBMxx	Bus minus 1 audio mix (for last fader)
LXCtrlRm	Control room monitor audio mix
LXCue1	Cue monitor audio mix
LXHDPN	Headphone monitor audio mix

LXHpNV	Headphone monitor audio mix non-variable
LXMM1	Mix Minus 1 audio mix
LXMM2	Mix Minus 2 audio mix
LXMM3	Mix Minus 3 audio mix
LXMM4	Mix Minus 4 audio mix
LX PGM	Program audio mix
LX AUD	Audition audio mix
LX AUX	Auxiliary audio mix
LX OL	OL (Off Line) audio mix
LXStu1	Studio 1 monitor audio mix
LXStu2	Studio 2 monitor audio mix
LXTally	Mute/Tally logic signals
LXTimer	Timer logic signals
LXWCMix1	Source for Control room/headphone/studio monitors

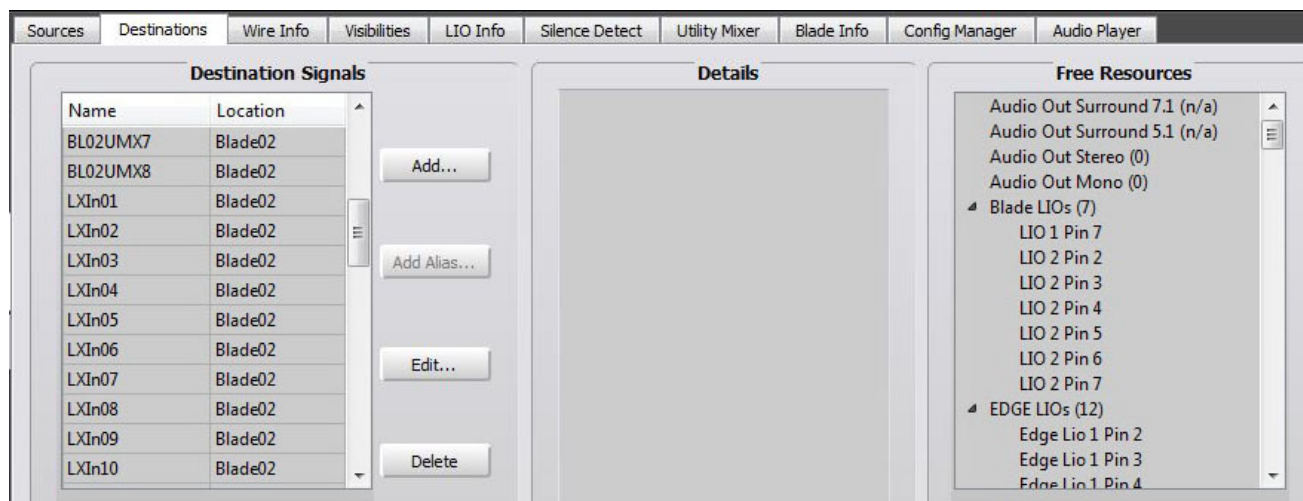

Destinations

LX24Cue	Cue monitor audio mix
LX24Hdpn	Input for Headphone monitor
LXCRx	External input for Control room monitor
LXCueEx	External Cue monitor audio mix
LXHDPNx	External input for Headphone monitor
LXIn01	Input to first fader channel
LXIn02	Input to second fader channel
.....	
LXInxx	Input to last fader channel
LXPgmEx	External input for Program audio mix

LXStu1x	External input for Studio 1 monitor
LXStu2x	External input for Studio 2 monitor
LXTkBack	Input for talkback channel
LXWldCrd	Input for switchable meters

Once these signals have been auto-generated, the control surface is now ready for use. You can make connections to the fader channels either with the Navigator GUI, or through the control surface front panel controls, and begin mixing. One thing you will notice is that, as soon as a fader channel is turned on, the system automatically locks the connection (as shown by the red line on the GUI screen) to prevent someone else from breaking your connection while you are on air.

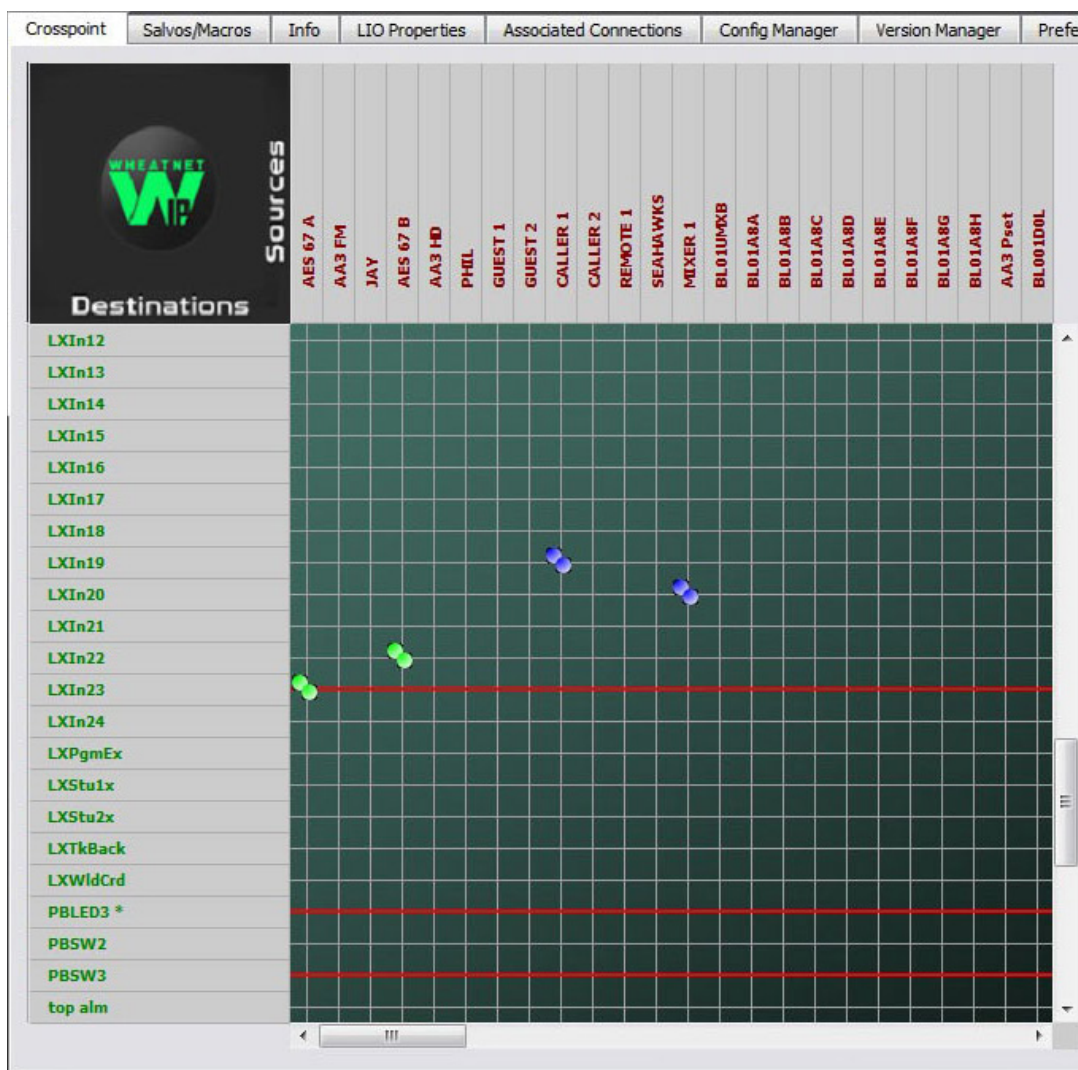

Remember, you must also make connections from the mixer signals to actual audio destinations before the mixes are routed through the WheatNet-IP system. Use the GUI to make these connections and lock them if necessary.

Lastly, you can continue setting up control surface options, for logic, mutes, signal visibility, and others. Consult the proper control surface manual for details.

THIS PAGE IS INTENTIONALLY LEFT BLANK

Appendix 2

Contents

Cisco 2960G, 2960S, and 2960X Configuration for WheatNet-IP..A-14

Overview.....	A-14
Privileged EXEC Mode	A-15
Global Configuration Mode	A-15
Configuring the VLAN Interface.....	A-15
IGMP Snooping Querier Configuration	A-16
Configuring Gigabit Ports Connecting to WheatNet-IP I/O BLADE3s and PC Drivers	A-16
Configuring Gigabit Ports Connecting to WheatNet-IP Control Surfaces, GP Panels, and XY Controllers.....	A-17
Configuring Ports for Linking to Other Network Switches	A-18
Checking and Saving the Switch Configuration.....	A-18

Cisco 3750G, 3560G, 3650, and 3850 Configuration for WheatNet-IP..A-19

Overview.....	A-19
Privileged EXEC Mode	A-20
Global Configuration Mode	A-20
Configuring the VLAN Interface.....	A-20
IGMP Snooping Querier Configuration	A-21
Configuring Gigabit Ports Connecting to WheatNet-IP I/O BLADE3s and PC Drivers	A-21
Configuring Gigabit Ports Connecting to WheatNet-IP Control Surfaces, GP Panels, and XY Controllers.....	A-22
Configuring Ports for Linking to Other Network Switches	A-23
Checking and Saving the Switch Configuration.....	A-23

HP Procurve 2810 Configuration for WheatNet-IPA-24

Overview.....	A-24
Privileged EXEC Mode	A-25
Global Configuration Level.....	A-25
Configuring the VLAN Interface.....	A-25
IGMP Querier Configuration.....	A-26
Configuring Gigabit Ports Connecting to WheatNet-IP I/O BLADE3s and PC Drivers	A-26
Configuring Gigabit Port Connecting to WheatNet-IP Navigator PC.....	A-27
Configuring Gigabit Ports Connecting to WheatNet-IP Control Surfaces, GP Panels, and XY Controllers.....	A-27
Configuring Ports for Linking to Other Network Switches	A-27
Checking and Saving the Switch Configuration.....	A-27

Cisco 2960G, 2960S, and 2960X Configuration for WheatNet-IP

Overview

Let's take a look at what needs to be done to get your Cisco 2960 ready for the installation of your WheatNet-IP system. Properly configuring your switch allows you to take advantage of the "management" capabilities to control network traffic and allows the network to operate at its highest potential. This becomes necessary to prevent overloading the network as the system size increases.

In this setup process you will setup switch ports according to the type of device connecting to that port. You will be setting things like VLAN access, Trunking, Speed, etc. Each section below gives you the exact commands needed to get your WheatNet-IP network up running.

Below is a chart that gives you some information about the commands you will be using to complete the setup. This can be a quick reference for you as well:

Command	Purpose
Configure Terminal	Enter Global configuration mode on switch
Interface	Enter interface configuration mode
Switchport mode access	Configures the port as an access port
Switchport mode Trunk	Configures port for trunking to other switches
Switchport nonegotiate	Prevents DTP frames from being generated
Spanning-tree portfast	Enables portfast on the switch port
Show running-config	Show the current running configuration
Write memory	Writes the configuration to memory on the switch
IP igmp snooping querier	Enables IGMP querier
IP igmp snooping querier timer expiry	Set the length of time until the IGMP querier expires

This document will explain the initial configuration of the Cisco 2960 series switch. To get started you will need the blue console cable that came with your switch. Go ahead and connect the console cable to the serial port on your PC and the RJ-45 to the console port on the switch. If your PC is not equipped with a serial port you will need a USB to Serial converter.

If you do not have the blue Cisco console cable there is an alternative. Cisco is now shipping with a USB console port on most of the new models. You can download the USB driver needed from the Cisco download site. You will need to download the Cisco_usbconsole_driver.

Next let's get your PC ready to communicate. You will need a terminal program such as HyperTerminal to finish this portion of the setup. HyperTerminal is an application you can use in order to connect your computer to other remote systems. These systems include other switches, routers, other computers, and Telnet sites.

HyperTerminal is located under the Start menu of your Windows 2000/XP PC. If you are using Windows Vista or Windows 7 or higher, you will need to install a similar terminal program to complete the setup.

To get started, open HyperTerminal and start a new connection. The terminal session should be setup using 9600Baud, 8 bit, no Parity, and no Flow control.

For those who are familiar with the Cisco IOS you may wish to jump ahead to the commands. For the rest, keep reading and we'll walk you through it step by step.

Along the way we'll even explain why we use the commands below so that you have some basic understanding of what you are doing. Hopefully you will walk away with some new found knowledge.

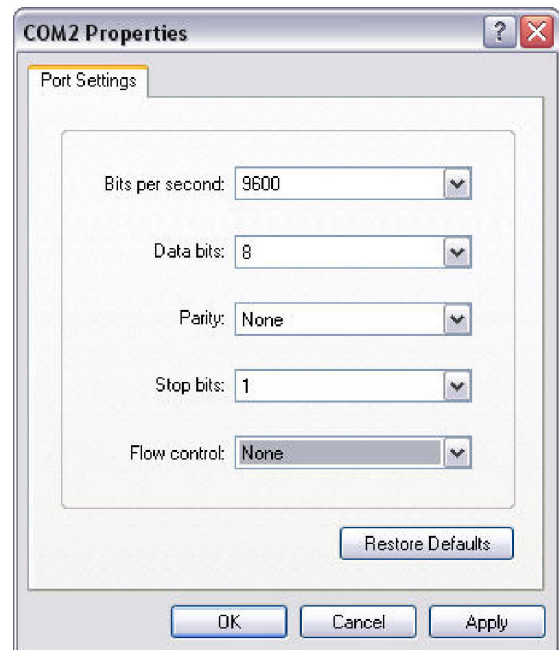

Privileged EXEC Mode

Now that we are connected to the switch let's log in. When logging into a Cisco switch under the default configuration, you are in user EXEC mode (level 1). In EXEC mode, you have limited access to the status of the switch. However, you can't make any changes or view the running configuration file.

Because of these limitations, you need to type *enable* to get out of user EXEC mode. By default, typing *enable* takes you to "Privileged" EXEC mode (Level 15). In the Cisco IOS, this level is equivalent to having root privileges in UNIX or administrator privileges in Windows. In other words, you have full access to the switch.

Let's get started on the configuration of your switch. Type "*enable*" command at the prompt. When prompted, enter the password and press Enter again. If no password has been defined just press Enter.

NOTE: The command prompt now ends with "#" indicating you are now at the Privileged EXEC mode (Level 15).

Global Configuration Mode

To enter the IP address and Subnet Mask for the VLAN or configure the switch ports you must first enter the configuration mode. To enter the global configuration mode on the 2960 series switch type "**Config T**" and press Enter. This places the switch in Global configuration mode and will allow configuration from the terminal window for the selected interface. You should now have the **switch (config)#** prompt.

Configuring the VLAN Interface

A VLAN is a switched logical network that is segmented based on the function or application. VLANs are virtual LANs but have the same attributes as the physical LAN. VLANs allow a user to create a virtual broadcast domain in which traffic can be isolated to keep it from reaching unwanted destinations. Any switch port can belong to a VLAN, and unicast, broadcast, and multicast packets are forwarded only to those end stations assigned to that VLAN.

Now that you are in the Global configuration mode you need to select the interface that you would like to configure. We'll start with the default VLAN.

The switch will come with a default VLAN enabled. In the default configuration all ports on the switch have been assigned to VLAN1. The command below selects the default VLAN for configuration to segment network traffic on the switch. If you are adding an additional VLAN to existing hardware, substitute that VLAN number in place of 1.

Enter the following commands (“XXX” = the actual network IP address):

```
interface Vlan1
ip address 192.168.87.XXX 255.255.255.0
end
```

Let's look at what you just set up. By typing “interface Vlan1” you are entering the configuration for that VLAN. The “IP Address” command simply sets the IP address of the VLAN1 interface for remote management purposes. The IP address must be unique on the network.

IGMP Snooping Querier Configuration

By default, IGMP is enabled globally on the switch. To set up IGMP Snooping Querier on the switch you must be in the Global configuration mode. To enter the configuration mode once again type “**Config T**” and press Enter.

Enter the following commands:

```
ip igmp snooping querier
ip igmp snooping querier max-response-time 25
ip igmp snooping querier timer expiry 205
end
```

By default IGMP Snooping is globally enabled on the switch. It is enabled on VLANs by default. Global IGMP snooping takes precedent over VLAN IGMP Snooping. If globally disabled you cannot enable IGMP Snooping on a per VLAN basis.

The commands above simply enable the querier on the switch and set a few values for maximum response time and the expiration duration for the querier.

Configuring Gigabit Ports Connecting to WheatNet-IP I/O BLADE3s and PC Drivers

Configuring the ports on the Cisco 2960 series switch is a key step in ensuring optimal performance of the Wheatnet-IP network. This section will guide you in the setup of each port used for WheatNet-IP I/O BLADE 3s.

Switch ports operate in one of three modes, dynamic, trunk, or access mode.

Switch ports connecting to Wheatstone IP devices must be in Access mode. Access mode places the port in static access mode and gives it access to the default VLAN. The switchport **nonegotiate** command disables the Dynamic Trunking Protocol and tells the port not to generate DTP frames.

To setup ports on the switch you must also be in the Global Configuration mode. To enter the configuration mode once again type “**Config T**” and press Enter.

Enter the following commands based on the OS versions of your switch:

- OS any version prior to version 15.0
Interface gig 0/x (x=the Ethernet port being configured)
switchport mode access
switchport nonegotiate
switchport block multicast
no ip igmp snooping tcn flood
spanning-tree portfast
end
- OS any version after 15.0
Interface gig 0/x (x=the Ethernet port being configured)
switchport mode access
switchport nonegotiate
no ip igmp snooping tcn flood
spanning-tree portfast
end

Ports on the 2960 series switch can be configured individually or in a “Range.” If range is desired type **Interface range gig0/1-24** using the desired number of ports.

Configuring Gigabit Ports Connecting to WheatNet-IP Control Surfaces, GP Panels, and XY Controllers

Enter the following commands based on the OS versions of your switch:

- OS any version prior to version 15.0
Interface gig 0/x (x=the Ethernet port being configured)
switchport mode access
switchport nonegotiate
switchport block multicast
no ip igmp snooping tcn flood
spanning-tree portfast
end
- OS any version after 15.0
Interface gig 0/x (x=the Ethernet port being configured)
switchport mode access
switchport nonegotiate
no ip igmp snooping tcn flood
spanning-tree portfast
end

Ports on the 2960 series switch can be configured individually or in a “Range.” If range is desired type **Interface range gig0/1-24** using the desired number of ports.

Configuring Ports for Linking to Other Network Switches

Trunk mode is used when connecting another switch to the port.

To set a specified port to trunk mode when connecting to another network switch the port needs to be set for Trunk mode. To setup Gigabit ports on the switch you must also be in the Global Configuration mode. To enter the configuration mode once again type “**Config T**” and press Enter.

Enter the following commands based on the OS versions of your switch:

- OS any version prior to version 15.0
Interface gig 0/x (x=the Ethernet port being configured)
switchport mode trunk
switchport nonegotiate
switchport block multicast
no ip igmp snooping tc flood
end
- OS any version after 15.0
Interface gig 0/x (x=the Ethernet port being configured)
switchport mode trunk
switchport nonegotiate
no ip igmp snooping tc flood
end

Checking and Saving the Switch Configuration

When you are done, check the switch configuration by typing the following command from the command prompt.

show running-config

Once you are sure you have the correct configuration you need to save it. You can save the configuration by typing one of the following commands:

copy running-config startup-config

or

write memory

Below is a diagram that shows you what a typical configuration might look like.

Sample Switch Configuration

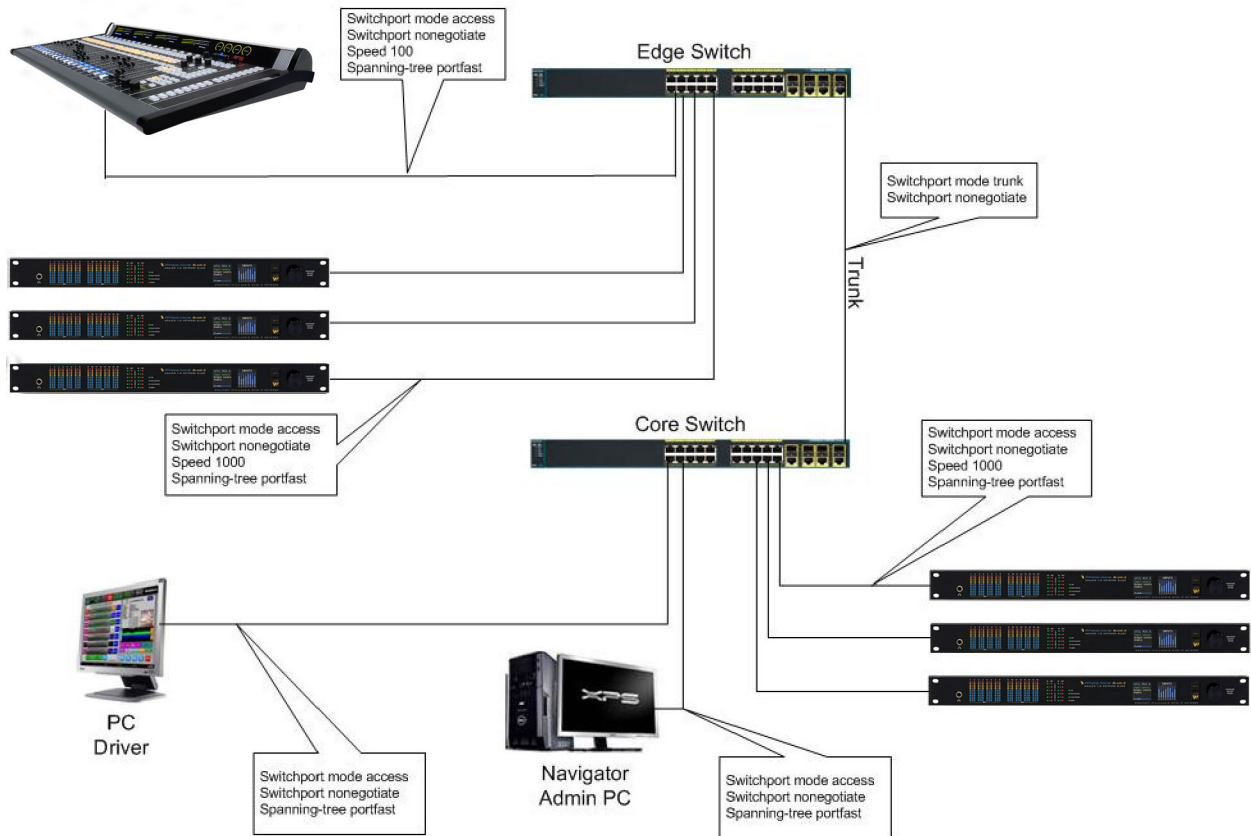

Cisco 3750G, 3560G, 3650, and 3850 Configuration for WheatNet-IP

Overview

Let's take a look at what needs to be done to get your Cisco Catalyst ready for the installation of your WheatNet-IP system. Properly configuring your switch allows you to take advantage of the "management" capabilities to control network traffic and allows the network to operate at its highest potential. This becomes necessary to prevent overloading the network as the system size increases.

In this setup process you will setup switch ports according to the type of device connecting to that port. You will be setting things like VLAN access, Trunking, Speed, etc. Each section below gives you the exact commands needed to get your WheatNet-IP network up running.

Below is a chart that gives you some information about the commands you will be using to complete the setup. This can be a quick reference for you as well:

Command	Purpose
Configure Terminal	Enter Global configuration mode on switch
Interface	Enter interface configuration mode
Switchport mode access	Configures the port as an access port
Switchport mode Trunk	Configures port for trunking to other switches
Switchport nonegotiate	Prevents DTP frames from being generated
Spanning-tree portfast	Enables portfast on the switch port
Show running-config	Show the current running configuration
Write memory	Writes the configuration to memory on the switch
IP igmp snooping querier	Enables IGMP querier
IP igmp snooping querier timer expiry	Set the length of time until the IGMP querier expires

This document will explain the initial configuration of the Cisco Catalyst switch. To get started you will need the blue console cable that came with your switch. Go ahead and connect the console cable to the serial port on your PC and the RJ-45 to the console port on the switch. If your PC is not equipped with a serial port you will need a USB to Serial converter.

If you do not have the blue Cisco console cable there is an alternative. Cisco is now shipping with a USB console port on most of the new models. You can download the USB driver needed from the Cisco download site. You will need to download the Cisco_usbconsole_driver.

Next let's get your PC ready to communicate. You will need a terminal program such as HyperTerminal to finish this portion of the setup. HyperTerminal is an application you can use in order to connect your computer to other remote systems. These systems include other switches, routers, other computers, and Telnet sites.

HyperTerminal is located under the Start menu of your Windows 2000/XP PC. If you are using Windows Vista or Windows 7 or higher, you will need to install a similar terminal program to complete the setup.

To get started, open HyperTerminal and start a new connection. The terminal session should be setup using 9600Baud, 8 bit, no Parity, and no Flow control.

For those who are familiar with the Cisco IOS you may wish to jump ahead to the commands. For the rest, keep reading and we'll walk you through it step by step.

Along the way we'll even explain why we use the commands below so that you have some basic understanding of what you are doing. Hopefully you will walk away with some new found knowledge.

Privileged EXEC Mode

Now that we are connected to the switch let's login. When logging into a Cisco switch under the default configuration, you are in user EXEC mode (level 1). In EXEC mode, you have limited access to the status of the switch. However, you can't make any changes or view the running configuration file.

Because of these limitations, you need to type *enable* to get out of user EXEC mode. By default, typing *enable* takes you to "Privileged" EXEC mode (Level 15). In the Cisco IOS, this level is equivalent to having root privileges in UNIX or administrator privileges in Windows. In other words, you have full access to the switch.

Let's get started on the configuration of your switch. Type "*enable*" command at the prompt. When prompted, enter the password and press Enter again. If no password has been defined just press Enter.

NOTE: The command prompt now ends with "#" indicating you are now at the Privileged EXEC mode (Level 15).

Global Configuration Mode

To enter the IP address and Subnet Mask for the VLAN or configure the switch ports you must first enter the configuration mode. To enter the global configuration mode on the Cisco Catalyst type "**Config T**" and press enter. This places the switch in Global configuration mode and will allow configuration from the terminal window for the selected interface. You should now have the **switch (config)#** prompt.

Configuring the VLAN Interface

A VLAN is a switched logical network that is segmented based on the function or application. VLANs are virtual LANs but have the same attributes as the physical LAN. VLANs allow a user to create a virtual broadcast domain in which traffic can be isolated to keep it from reaching unwanted destinations. Any switch port can belong to a VLAN, and unicast, broadcast, and multicast packets are forwarded only to those end stations assigned to that VLAN.

Now that you are in the Global configuration mode you need to select the interface that you would like to configure. We'll start with the default VLAN.

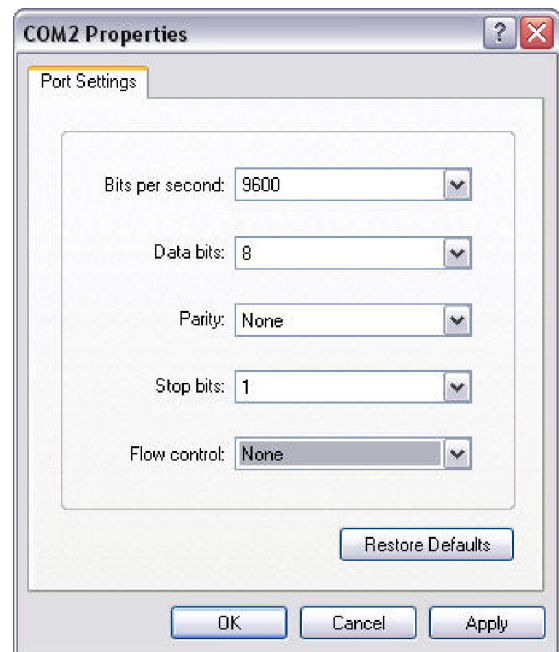

The switch will come with a default VLAN enabled. In the default configuration all ports on the switch have been assigned to VLAN1. The command below selects the default VLAN for configuration to segment network traffic on the switch. If you are adding an additional VLAN to existing hardware, substitute that VLAN number in place of 1.

Enter the following commands (“XXX” = the actual network IP address):

```
interface Vlan1
ip address 192.168.87.XXX 255.255.255.0
end
```

Let’s look at what you just set up. By typing “interface Vlan1” you are entering the configuration for that VLAN. The “IP Address” Command simply sets the IP address of the VLAN1 interface for remote management purposes. The IP address must be unique on the network.

IGMP Snooping Querier Configuration

By default, IGMP is enabled globally on the switch. To set up IGMP Snooping Querier on the switch you must be in the Global configuration mode. To enter the configuration mode once again type “**Config T**” and press Enter.

Enter the following commands:

```
ip igmp snooping querier
ip igmp snooping querier max-response-time 25
ip igmp snooping querier timer expiry 205
end
```

By default IGMP Snooping is globally enabled on the switch. It is enabled on VLANs by default. Global IGMP snooping takes precedent over VLAN IGMP Snooping. If globally disabled you cannot enable IGMP Snooping on a per VLAN basis.

The commands above simply enable the querier on the switch and set a few values for maximum response time and the expiration duration for the querier.

Configuring Gigabit Ports Connecting to WheatNet-IP I/O BLADE3s and PC Drivers

Configuring the ports on the Cisco Catalyst is a key step in ensuring optimal performance of the WheatNet-IP network. This section will guide you in the setup of each port used for WheatNet-IP I/O BLADE3s.

Switch ports operate in one of three modes, dynamic, trunk, or access mode.

Switch ports connecting to Wheatstone IP devices must be in Access mode. Access mode places the port in static access mode and gives it access to the default VLAN. The **switchport nonegotiate** command disables the Dynamic Trunking Protocol and tells the port not to generate DTP frames.

To set up ports on the switch you must also be in the Global Configuration mode. To enter the configuration mode once again type “**Config T**” and press Enter.

Enter the following commands based on the OS versions of your switch:

- OS any version prior to version 15.0
Interface gig 0/x (x=the Ethernet port being configured)
switchport mode access
switchport nonegotiate
switchport block multicast
no ip igmp snooping tcn flood
spanning-tree portfast
end
- OS any version after 15.0
Interface gig 0/x (x=the Ethernet port being configured)
switchport mode access
switchport nonegotiate
no ip igmp snooping tcn flood
spanning-tree portfast
end

Ports on the Cisco Catalyst switches can be configured individually or in a “Range.” If range is desired type **Interface range gig1/0/1-24** using the desired number of ports.

Configuring Gigabit Ports Connecting to Wheatnet IP Control Surfaces, GP Panels, and XY Controllers

Enter the following commands based on the OS versions of your switch:

- OS any version prior to version 15.0
Interface gig 0/x (x=the Ethernet port being configured)
switchport mode access
switchport nonegotiate
switchport block multicast
no ip igmp snooping tcn flood
spanning-tree portfast
end
- OS any version after 15.0
Interface gig 0/x (x=the Ethernet port being configured)
switchport mode access
switchport nonegotiate
no ip igmp snooping tcn flood
spanning-tree portfast
end

Ports on the Cisco Catalyst switches can be configured individually or in a “Range.” If range is desired type **Interface range gig0/1-24** using the desired number of ports.

Configuring Ports for Linking to Other Network Switches

Trunk mode is used when connecting another switch to the port.

To set a specified port to trunk mode when connecting to another network switch the port needs to be set for Trunk mode. To set up Gigabit ports on the switch you must also be in the Global Configuration mode. To enter the configuration mode once again type “**Config T**” and press Enter.

Enter the following commands based on the OS versions of your switch:

- OS any version prior to version 15.0
Interface gig 0/x (x=the Ethernet port being configured)
switchport trunk encapsulation dot1q (Only 3750 and 3560)
switchport mode trunk
switchport nonegotiate
switchport block multicast
no ip igmp snooping tcn flood
end
- OS any version after 15.0
Interface gig 0/x (x=the Ethernet port being configured)
switchport trunk encapsulation dot1q (Only 3750 and 3560)
switchport mode trunk
switchport nonegotiate
no ip igmp snooping tcn flood
end

Checking and Saving the Switch Configuration

When you are done, check the switch configuration by typing the following command from the command prompt.

show running-config

Once you are sure you have the correct configuration you need to save it. You can save the configuration by typing one of the following commands:

copy running-config startup-config

or

write memory

Below is a diagram that shows you what a typical configuration might look like.

Sample Switch Configuration

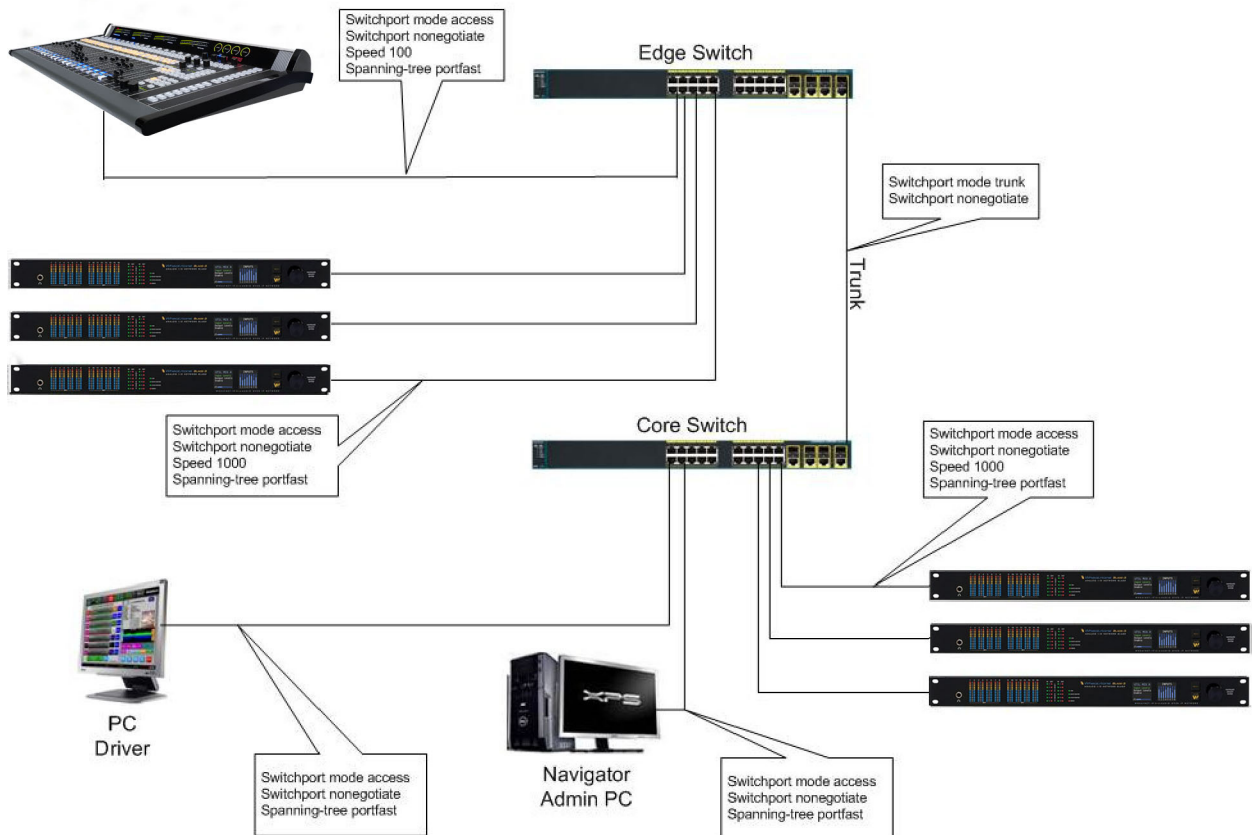

HP Procurve 2810 Configuration for WheatNet-IP

Overview

Let's take a look at what needs to be done to get your HP Procurve 2810 switch ready for the installation of your WheatNet-IP system. Properly configuring your switch allows you to take advantage of the "management" capabilities to control network traffic and allows the network to operate at its highest potential. This becomes necessary to prevent overloading the network as the system size increases.

In this setup process you will setup switch ports according to the type of device connecting to that port. You will be setting things like VLAN access, Trunking, Speed, etc. Each section below gives you the exact commands needed to get your WheatNet-IP network up running.

Below is a chart that gives you some information about the commands you will be using to complete the setup. This can be a quick reference for you as proceed through the configuration.

Command	Purpose
Configure Terminal	Enter Global configuration mode on switch
Interface	Enter interface configuration mode
Show running-config	Show the current running configuration
Write memory	Writes the configuration to memory on the switch
IP igmp querier	Enables IGMP querier

This document will explain the initial configuration of the HP Procurve 2810 switch. To get started you will need the HP provided console cable that came with your switch. Go ahead and connect the console cable to the serial port on your PC and the RJ-45 to the console port on the lower left corner on the front panel of the switch. If your PC is not equipped with a serial port you will need a USB to Serial converter.

Next let's get your PC ready to communicate. You will need a terminal program such as HyperTerminal to finish this portion of the setup. HyperTerminal is an application you can use in order to connect your computer to other remote systems. These systems include other switches, routers, other computers, and Telnet sites.

HyperTerminal is located under the Start menu of your Windows 2000/XP PC. If you are using Windows Vista or Windows 7 you will need to install a similar terminal program to complete the setup.

To get started, open HyperTerminal and start a new connection. The terminal session should be setup using 9600Baud, 8 bit, no Parity, and no Flow control.

For those who are familiar with the HP Procurve switches you may wish to jump ahead to the commands. For the rest, keep reading and we'll walk you through it step by step.

Along the way we'll even explain why we use the commands below so that you have some basic understanding of what you are doing. Hopefully you will walk away with some newfound knowledge.

Privileged EXEC Mode

Now that we are connected to the switch let's login. When logging into an HP Procurve switch under the default configuration, there are two privilege level modes. These modes are Operator and Manager. Operator level will allow you to see configuration information without being able to modify any of the current settings. You also have limited access to the status of the switch. But again, you can't make any changes to the running configuration file.

Because of these limitations, you need to type *enable* to get out of Operator 85.59 - 2.2* Privilege mode. By default, typing *enable* takes you to "Manager Privileges" mode. Under Manager Privilege there are three additional levels of access, Manager, Global Configuration, Context Configuration.

Let's get started on the configuration of your switch. Type "*enable*" at the prompt. When prompted, enter the password and press Enter again. If no password has been defined just press Enter.

NOTE: The command prompt now ends with "#" indicating you are now at the Manager level mode.

ProCurve#_

Global Configuration Level

To enter the IP address and Subnet Mask for the VLAN or configure the switch ports you must first enter the configuration level. To enter the global configuration level type "**Config T**" and press enter. This places the switch in Global configuration mode and will allow configuration from the terminal window for the selected interface. This level is equivalent to having root privileges in UNIX or administrator privileges in Windows. In other words, you have full access to the switch.

You should now have the **ProCurve(config)#** prompt.

Configuring the VLAN Interface

A VLAN is a switched logical network that is segmented based on the function or application. VLANs are virtual LANs but have the same attributes as the physical LAN. VLANs allow a user to create a virtual broadcast domain in which traffic can be isolated to keep it from reaching unwanted destinations. Any switch port can belong to a VLAN, and unicast, broadcast, and multicast packets are forwarded only to those end stations assigned to that VLAN.

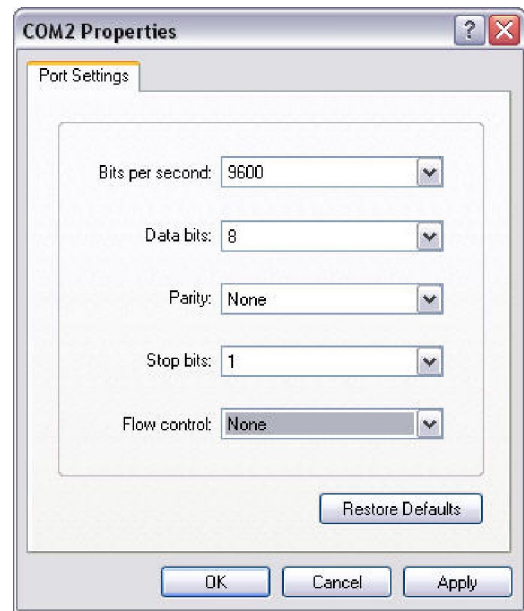

Now that you are in the Global configuration mode you need to select the interface that you would like to configure. We'll start with the default VLAN.

The switch will come with a default VLAN enabled. In the default configuration all ports on the switch have been assigned to VLAN1 (DEFAULT_VLAN). The command below selects the default VLAN for configuration to segment network traffic on the switch. If you are adding an additional VLAN to existing hardware, substitute that VLAN number in place of 1.

Enter the following commands ("XXX" = the actual network IP address)

```
Vlan1
ip address 192.168.87.XXX 255.255.255.0
end
```

Let's look at what you just setup. By typing "Vlan1" you are entering the configuration for that VLAN. The "IP Address" Command simply sets the IP address of the VLAN1 interface for remote management purposes. The IP address must be unique on the network.

IGMP Querier Configuration

By default, IGMP is disabled globally on the switch. To setup IGMP Multicast filtering on the switch you must be in the Global configuration mode. To enter the configuration mode once again type "**Config T**" and press enter.

Enter the following commands:

```
ip igmp
ip igmp querier
end
```

The commands above simply enable IGMP on the default VLAN and the querier on the switch.

Configuring Gigabit Ports Connecting to WheatNet-IP I/O BLADE 3s and PC Drivers

Configuring the ports on the HP Procurve Series 2810 is a key step in ensuring optimal performance of the WheatNet-IP network. This section will guide you in the setup of each port used for WheatNet-IP I/O BLADE 3s.

To setup ports on the switch you must also be in the Global Configuration mode. To enter the configuration mode once again type "**Config T**" and press enter.

Enter the following commands

```
Interface X (X=the Ethernet port being configured)
speed 1000-FULL
end
```

Ports on the HP Procurve can be configured individually or in a "Range." If range is desired type **Interface 1 - 24** (for example), using the desire number of ports.

Configuring Gigabit Port Connecting to WheatNet-IP Navigator PC

The Navigator PC port can be left in the default mode. Speeds will vary depending on the type of network card installed in the PC. It is recommended that a Gigabit card be installed in the PC, however it is not mandatory.

Configuring Gigabit Ports Connecting to WheatNet-IP Control Surfaces, GP Panels, and XY Controllers

Enter the following commands

```
Interface X (X=the Ethernet port being configured)
speed 100-FULL
end
```

Once again, the ports on the HP Procurve can be configured individually or in a “Range.” If range is desired type **Interface 1 - 24** (for example), using the desired number of ports.

Configuring Ports for Linking to Other Network Switches

Trunk mode is used when connecting another switch to the port.

To set a specified port to trunk mode when connecting to another network switch the port needs to be set for trunk mode. To setup Gigabit ports on the switch you must also be in the Global Configuration mode. To enter the configuration mode once again type “**Config T**” and press enter.

Enter the following commands.

```
Interface X (X=the Ethernet port being configured)
trunk
end
```

Checking and Saving the Switch Configuration

When you are done, check the switch configuration by typing the following command from the command prompt.

```
show running-config
```

Once you are sure you have the correct configuration you need to save it. You can save the configuration by typing one of the following commands

```
copy running-config startup-config
```

or

```
write memory
```

Below is a diagram that shows you what a typical configuration might look like.

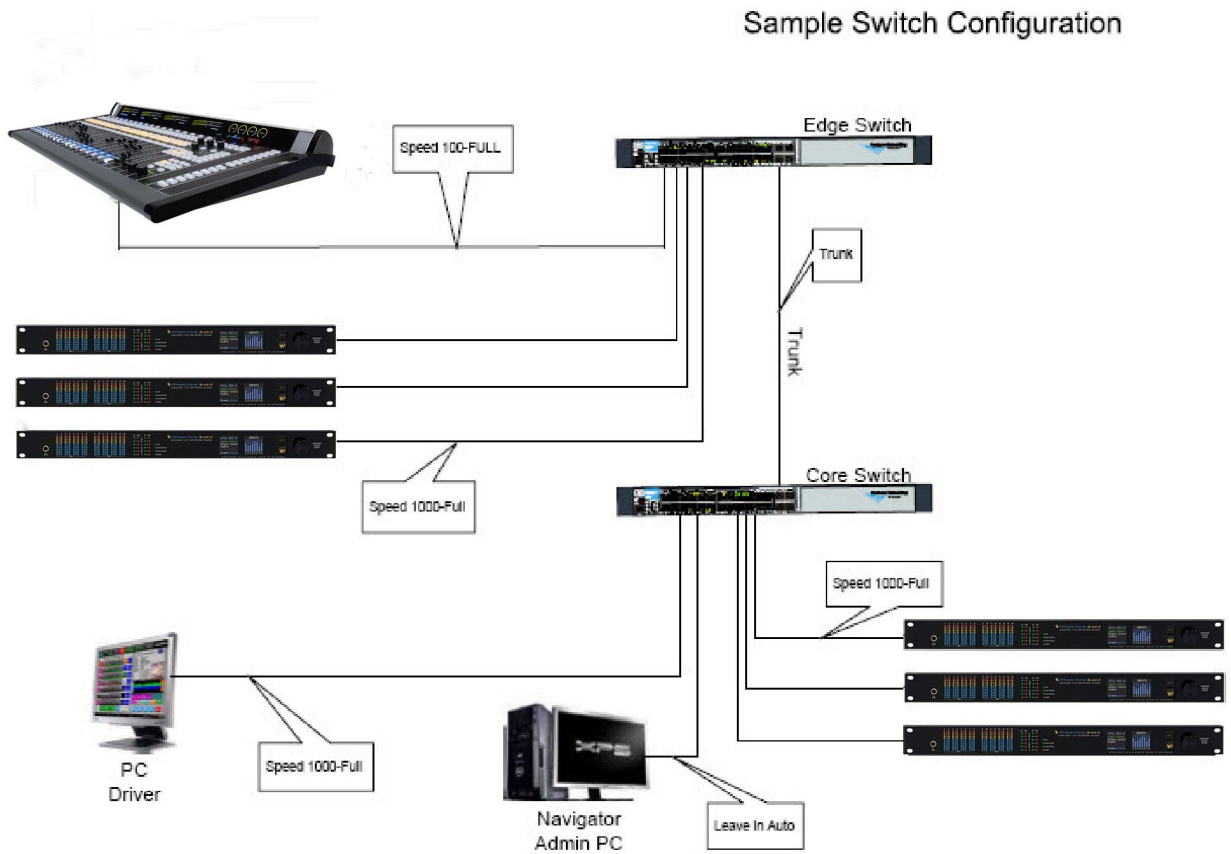

Appendix 3

Contents

WheatNet-IP Logic Functions and Examples	A-30
Category 1: Direct Logic	A-30
VDip Function	A-30
Programmable Buttons	A-33
Category 2: Audio Associated Logic.....	A-38
Category 3: Discrete Logic.....	A-43
Category 4: Action Logic.....	A-47

WheatNet-IP Logic Functions and Examples

As described in this manual, the WheatNet-IP system provides for certain logic (i.e. non audio) related functions and controls. The messaging structure for these functions is entirely contained within the WheatNet-IP hardware itself, and distributed over the same LAN connection as is the audio. No PCs are required, other than to use the WheatNet-IP Navigator GUI application to make the configurations and programming needed.

There are many different logic functions and controls available in the WheatNet-IP system; these can be sorted into four different categories. This appendix will provide specific examples in these categories to demonstrate the category as well as provide step by step instructions on how to program the function with the Navigator GUI software.

Category 1: Direct Logic

This type of logic function acts directly on and controls the operation of certain control surface features. Direct logic operation is independent of any BLADE 3s and/or physical logic ports. Direct logic functions are available on the control surfaces (Evolution series, LX-24), and are further classed as to control surface functions and programmable buttons.

VDip Function

Direct logic control surface functions are programmed on the control surface itself under the Options>VDIP Settings window. These VDIP (Virtual Dip Switch) functions affect how the control surface works, and can be set to act either globally, for all input sources, or differently depending on the source.



The following functions are available:

PFL/Cue Drop Out: Any fader channel that has been placed in Cue will automatically be removed from Cue when the channel is turned ON.

Timer Restart: Forces a return to 0 and start counting on the Timer display when a fader channel is turned ON.

Machine Start Pulsed: When a signal is assigned to a fader, turning the fader ON generates a Machine Start logic that can be used to start a machine, such a CD player.

EFS: Moving a fader up from full off will automatically trigger a START logic command.

Fader Cue: Pulling a fader all the way down automatically puts the channel into Cue.

Remote Ready: Forces the fader channel OFF indicator to be driven by an external READY logic signal.

Program D Pre Fader: Sets the PGM D bus to be pre fader.

Program D Pre ON: Sets the PGM D bus to be ON independent of the ON/OFF switch.

Program D Off Line: Determines what will be heard at the fader's Bus Minus output when the fader is OFF.

Studio 1 Mute: Mutes the studio 1 output when the fader channel is turned ON.

Studio 2 Mute: Mutes the studio 2 output when the fader channel is turned ON.

HP Mute: Mutes the headphone output when the fader channel is turned ON.

CR Mute: Mutes the control room output when the fader channel is turned ON.

Cue Mute: Mutes the cue output when the fader channel is turned ON.

Studio 1 Tally: Activates a tally 1 signal when the fader channel is turned ON.

Studio 2 Tally: Activates a tally 2 signal when the fader channel is turned ON.

Studio 3 Tally: Activates a tally 3 signal when the fader channel is turned ON.

Studio 4 Tally: Activates a tally 4 signal when the fader channel is turned ON.

Bus Minus Direct Out: For each signal, determines if the Bus Minus output is a mix-minus of the selected BUS MINUS SOURCE (unchecked) or a Direct Output (checked) On signals where the BUS MINUS DIRECT OUT box is checked, the PGM D Off Line box (above) will have no effect..

Bus Minus Source: For each signal, determines which bus the Bus Minus output is a mix-minus of. Any of the four PGM busses, the four Mix Minus busses, or the four AUX busses can be selected as Bus Minus Source.

As a programming example, let's use the CR Mute function. This function is commonly used to mute the control room speaker outputs while the talent microphones are turned ON to avoid feedback from occurring if the amplified microphone signal is passed out the speakers and then picked back up by the microphone. The intention is that whenever a microphone channel that happens to be located close to the control room speakers is turned ON, the speakers are automatically turned OFF to prevent the feedback. Once the microphone channel is turned OFF the control room speakers are automatically turned back ON.

To enable this function, first identify the microphone source(s) that is(are) located near the control room speakers. These are the source signals that could cause feedback. In this situation you would normally want this logic action (mute the speakers) to happen only with these particular source signals.

Open the VDIP Settings form by pressing the Options tab of the control surface GUI and choosing it from the AVAILABLE OPTIONS scroll down list. This menu can be password protected so you must have access privileges before you can modify these settings.

Once the VDIP Settings form is open, click on the SIGNAL button to change the VDIP mode from the default global to per source, and then scroll through the INPUT SIGNAL LIST until you highlight and double click the name of the audio source (the mic signal) you wish to activate the muting. The source name should appear in the SIGNAL window. Click on the CR Mute check box and hit the APPLY button. The control surface has now been programmed to automatically mute the control room output signal whenever any fader channel that has the mic signal routed to it is turned ON. A caveat: this feature does not actually mute the speakers, but only mutes the control room output signal. If, as is normal, you have connected the speakers to an amplifier whose input is connected to the control room output signal, this feature will work as expected; however, if for some reason the speakers are connected to some other output signal, they will not be muted.

Repeat the process for any other mic signals that could cause feedback with the control room speakers.

In similar fashion you can activate any of the other VDIP functions as you see fit. Some of these, such as the mutes and tallys, may need to be set on a per signal basis, while others, such as Timer Restart or PFL/Cue Drop Out, are better suited to the default Global (i.e. for any signal) setting.

Programmable Buttons

The control surfaces can be equipped with a number of switches whose operational functions can be programmed by the user. These are located in two different areas of the control surface panels. Possibilities include a pair of switches located above each fader on the input panels, and a number of switches located on the monitor panel.

The programmable buttons on the fader panels are meant for enabling higher level audio functions such as EQ or Dynamics on an as-needed basis. The functions available are:

Take a Source: Automatically select a specific source signal for the fader channel.

Take a Preset: Select a previously saved set of processing functions (a Preset) and apply them to the fader channel.

Toggle EQ In/Out: Change the current in/out mode of the EQ settings on the channel.

Toggle Low Pass Filter: Change the current in/out mode of the low pass filter.

Toggle High Pass Filter: Change the current in/out mode of the high pass filter.

Toggle Compressor: Change the current in/out mode of the compressor.

Toggle Expander: Change the current in/out mode of the expander.

Change Channel Mode: Step through the input channel signal modes: stereo, mono, left only, right only.

Toggle Left Phase: Change the input polarity setting for the left audio channel.

Toggle Right Phase: Change the input polarity setting for the right audio channel.

Clear Button Programming: Remove any previously set up button programming.

As an example, let's program the left programmable button on fader #1 of a LX-24 control surface to be an EQ IN/OUT switch. Again, these functions are password protected so you must have access privileges to program them. Also, not all surfaces will have all functions available so the list of functions may be less than is shown here.



LX-24 Panels



First press the SET button for fader #1 on the input panel. The VGA screen will switch to settings for fader #1. If not already visible, click on the INPUT tab. In the PROGRAMMABLE section of the window, left click on the appropriate display window (top window for left button, bottom window for right button); a drop down list of functions will appear. Select the “Toggle EQ In/Out” function.

The left hand button on fader channel #1 will now function as an EQ In/Out switch. In a like manner, other functions and other input channel buttons can be programmed.

To remove any programming from a button, choose “Clear This Button” as the function, the button will now do nothing.

The programmable buttons on the monitor panel have different functions tied to more general control surface functions rather than input specific functions. Selecting the Programmable Buttons from the AVAILABLE OPTIONS scroll down list of the Options tab on the control surface VGA display (this is password protected so you must have access privileges) opens a drop down window listing the monitor panel programmable buttons (up to 12 max, the number will vary with the control surface model). For each button there is a drop down window displaying its current operating mode. The default mode is MOMENTARY/SURFACE LED.

The available programmed mode functions are:

Momentary/Surface LED: Causes the button function to be momentary and the button LED indicator to be activated directly by the button’s position.

Tally LED: The button LED indicator becomes an available logic output to be controlled externally.

Toggle: The button functions as an alternate action; push ON, push OFF switch.

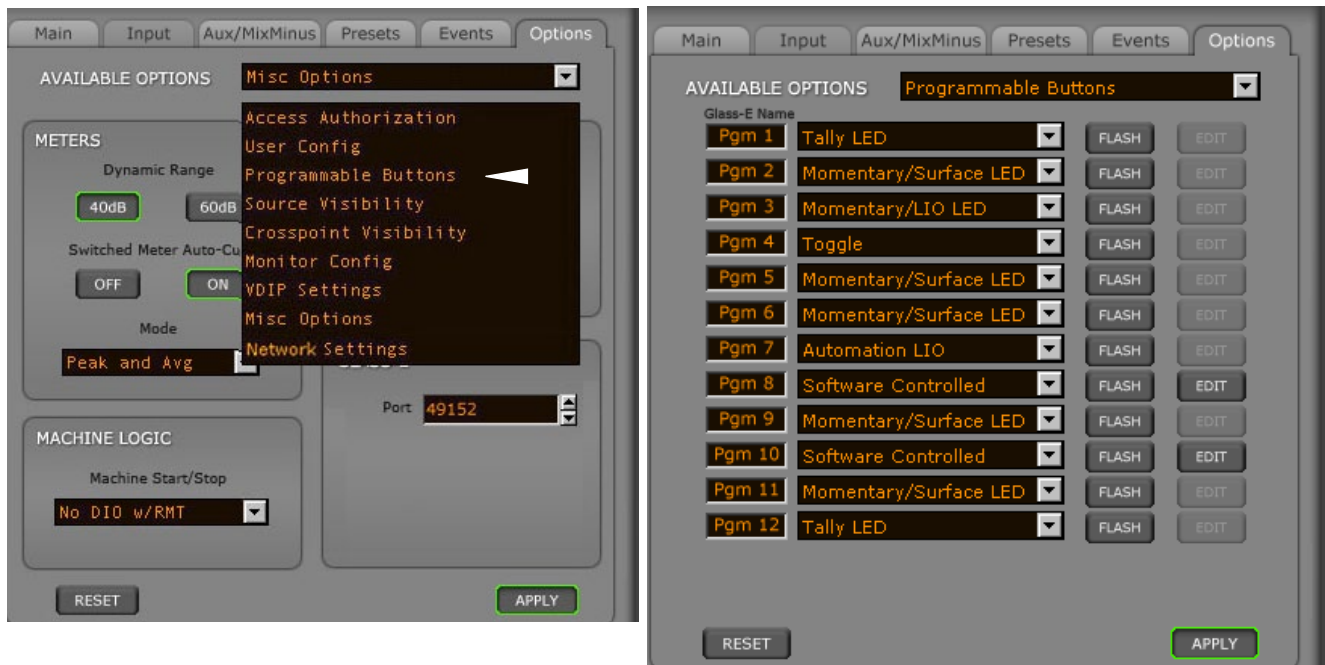

Momentary/LIO LED: Causes the button function to be momentary and the button LED indicator controlled externally.

Automation LIO: Causes the button to work with, and the LED indicator to be controlled by, an external 3rd party device such as automation.

Software Controlled: Enables a list of functions to choose for the button to activate.

Load an Event: Loads a previously saved event (a show or set of control surface settings).

PFL Clear: Deactivates any PFL or Cue functions.

Show Main window: Switches the VGA display to the main window.

Show Input Source screen: Switches the VGA display to the input source select view.

Show EQ screen: Switches the VGA display to the EQ settings view (some surfaces may not be equipped with this function).

Show Dynamics screen: Switches the VGA display to the Dynamics settings view (some surfaces may not be equipped with this function).

Let's choose a couple of examples for the monitor panel programmable buttons. First let's enable button #1 to switch the control surface settings to your morning show. Before you can do this, you must of course have saved a set up for your morning show in the first place. If you haven't already done this consult your control surface operator's manual for details, but in brief you must set up the surface exactly as you want it to be. This includes source selection, channel assignments, EQ/Dynamics settings, etc.; in short, just how you want the control surface to be running during the show. Save these settings as an event with the name "Morning" or "Zoo" or whatever else you want to call it.

From the control surface VGA display screen choose Options>Programmable buttons. For button #1 choose "Software Controlled" from the drop down list, and the EDIT button will illuminate. Click on the EDIT button to open the functions list and double

click on “Load an Event”. This opens the Events list; select “Morning” or whatever the name of your desired event is and then click *APPLY*. Button #1 will now recall the “Morning” event set up whenever it is pressed.

For the second example let’s make button #2 perform a talkback function to a remote location, say destination #5 in BLADE 2. We will make this work by making a temporary crosspoint connection of our talkback signal (typically the talent mic), which in our example is source #3 in BLADE 1, to destination #5 in BLADE 2. A temporary connection in the WheatNet-IP system is where a destination’s normal audio source connection is temporarily removed (normally for as long as a button is held down) and a secondary connection is substituted. Once the button is released, the secondary connection is removed and the original one is restored.

From the control surface VGA display screen choose Options>Programmable buttons. For button #2 choose “Momentary/Surface LED” which is the default. This tells the control surface that you want programmable button #2 to act as a momentary switch (it stays engaged for only as long as the button is held down) and the switch indicator LED is to be illuminated directly by the surface for as long as the button is held down.

We’ve told the surface how we want the button to act; we must now tell it what we want it to do. If not already running, we must connect and start the Navigator GUI software, because this is where we’ll program the crosspoint connections.

In the System Pane view, click on the engine BLADE for our control surface to display the Blades tabs and click on LIO Info tab. The LIO properties window will open, showing a listing of all the available logic signals for the control surface.

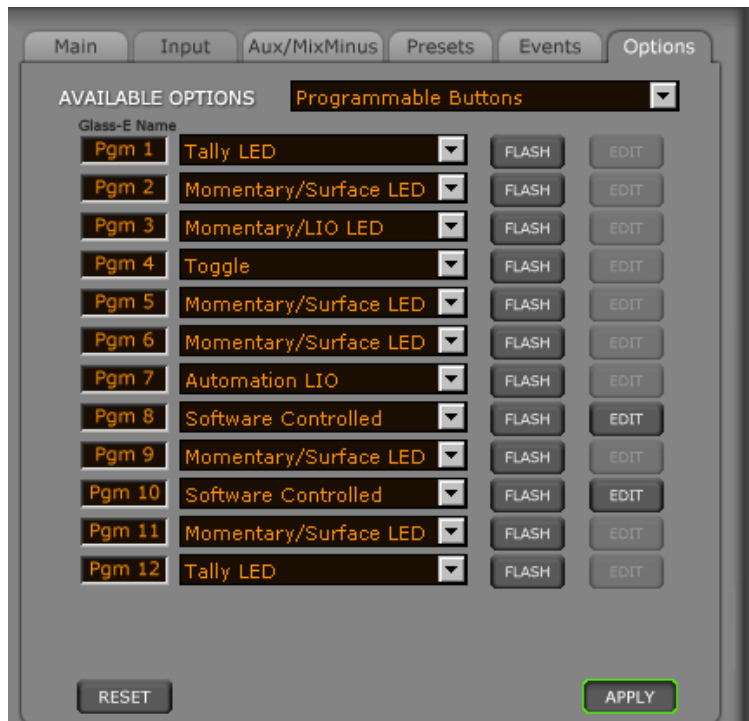

Select “Spare Btn 2” from the list to choose our button and double click on the “Momentary Connection” field; the LIO CONFIGURATION window will open. Click on the MOMENTARY CONNECTION check box to enable it.

Pin Name	Input	Output	Function	Signal	Fire Salvo	Momentary
LIO 2 Pin 3	<input type="radio"/>		<none>	<none>	<none>	<none>
LIO 2 Pin 4	<input type="radio"/>		<none>	<none>	<none>	<none>
LIO 2 Pin 5	<input type="radio"/>		<none>	<none>	<none>	<none>
LIO 2 Pin 6	<input type="radio"/>		<none>	<none>	<none>	<none>
LIO 2 Pin 7	<input type="radio"/>		<none>	<none>	<none>	<none>
Software LIOs						
Surface 1 Spares						
Spare Btn 1	<input type="radio"/>	<input type="radio"/>			Salvo 1	<none>
Spare Btn 2	<input type="radio"/>	<input type="radio"/>			Salvo 3	<none>
Spare Btn 3	<input type="radio"/>	<input type="radio"/>			<none>	DST TALLY => SRC LOGIC
Spare Btn 4	<input type="radio"/>				<none>	DST => SRC PHONE
Spare Btn 5	<input type="radio"/>				<none>	DST => SRC BL01UMXB
Spare Btn 6	<input type="radio"/>				<none>	<none>
Spare Btn 7	<input type="radio"/>				<none>	<none>
Spare Btn 8	<input type="radio"/>				<none>	<none>
Spare Btn 9	<input type="radio"/>				<none>	<none>
Spare Btn 10	<input type="radio"/>				<none>	<none>
Spare Btn 11	<input type="radio"/>				Salvo 2	<none>
Spare Btn 12	<input type="radio"/>				Salvo 1	<none>
Spare Btn 13	<input type="radio"/>				Salvo 2	<none>
Spare Btn 14	<input type="radio"/>				<none>	DST TALLY => SRC LOGIC
EDGE LIOs						

Select BL02D05 or whatever you’ve named it from the “Destination Signal” drop down list.

From the “Source Signal” drop down list select BL01S03 or whatever you’ve named the 3rd source in BLADE #1, which is your talkback signal. Finally, click OK and the momentary connection information will be displayed on the “Spare Btn 2” line.

That’s all there is to it; whenever you press programmable button #2 on the monitor panel of the control surface, destination #5 in BLADE #2 will receive audio from source #3 in BLADE #1 (the talent mic signal) until the button is released.

In a like manner all of the programmable buttons on the control surfaces can be programmed for any of the available functions. As a final note, once you have completed your programming, please be aware that Wheatstone can provide custom laser etched buttons with whatever labels you specify - a very handy way to dress up your control surfaces. Contact Wheatstone Sales or Customer Support if you wish to order custom buttons.

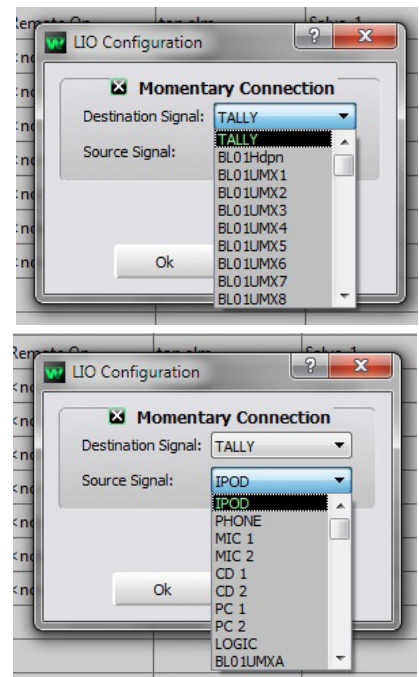

Category 2: Audio Associated Logic

There are many logic functions that are associated with or tied to specific audio signals. You may have a START or a STOP logic function that associates with a specific CD player or Automation machine, or ON and OFF logic functions that associate with a control surface fader channel. In the good old days you would have to wire a multi-conductor control cable from the logic ports on the machine to the logic ports on your console. Once you were done, those logic connections would only work for that one machine and one fader channel; if you patched your audio to a different channel, the logic wouldn't work right anymore. For this reason (and to make it easier to set it all up in the first place), general practice was to wire all of these connections up to punchblocks so connections could be changed via punch downs rather than rewiring complicated multi-pin connectors.

It's much easier with the WheatNet-IP system. First of all, many devices (including Wheatstone control surfaces) now support logic control directly over Ethernet connections, so separate logic wiring isn't needed. For that equipment that still requires physical logic connections, WheatNet-IP devices provide 12 available logic connections on every BLADE 3, and the system provides for audio associated logic. That means the only physical wiring you'll need for these devices is a direct connection from the device logic connector to the RJ-45 jacks on a BLADE 3.

Here's how it works. Each audio signal within the WheatNet-IP system – that's every source and every destination including control surfaces – can have up to 12 different logic functions (from a list of 500 different types) associated with it. Whenever an audio crosspoint connection is made between a source and a destination, the system looks for matching logic functions (for example START and STOP). For every matching function, a virtual logic connection is established such that the logic input will control the logic output. If the audio connection is changed, the system looks for matching functions in the new connection. In this manner the logic functions are associated with or attached to the audio devices, and hence follow with whatever audio connections are made.

This makes it easy to enable complex logic functionality without a lot of physical wiring, and minimizes the need for punchblocks or other cross connect and fan out wiring devices.

For an example, let's set up our system so that a control surface ON button will start a Denon DNC620 CD player. This machine has a D-sub 25 logic connector, with a START function located on pin #9 and Command Common located on pin #23. A momentary connection between pins 9 and 23 will cause the machine to begin playback. Let's assume that the CD player is located in our Air studio, which has an LX-24 control surface and 88cbe console BLADE #1. We'll say that the CD's stereo audio output is connected to stereo input 7 on BLADE #1 and we have given this source signal the obvious name "CD1." Let's further assume that we have already used the first two logic ports connection on this BLADE, so we want to use the third logic port connection, pin #4, to START the DNC620. Your system will likely have different BLADE and port numbers than these in the example; just substitute your ID #s as necessary.

First we need to wire the logic ports, connecting pin #4 and #1 of the first logic connector on BLADE #1 to pins #9 and #23 respectively on the DB-25 connector of the DNC620 machine. That's all the physical wiring we will need to do for this function.

In the WheatNet-IP Navigator GUI, we need to locate the audio signal that represents the CD audio; that is BL05S07 which we have subsequently named “CD.” On the crosspoint grid we can search until we see the source signals for BLADE #1, and then locate “CD.”

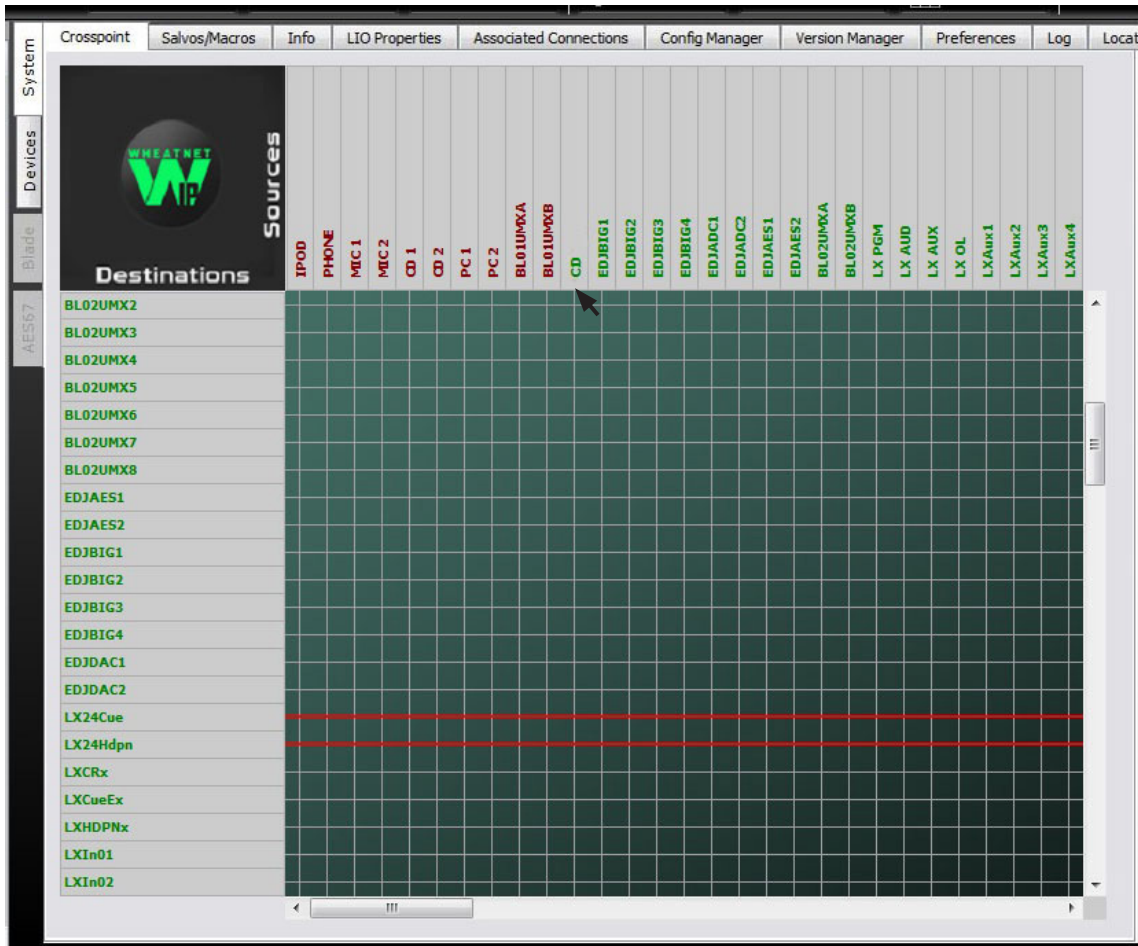

Right click on the source signal name “CD” which opens the signal edit window and choose “Modify Signal...” from the popup. Click on the LIO Info tab of the Source Signal Wizard to open the LIO info view. Click on the *Add* button to open the “Assign an LIO to CD” window. Click and select pin 4. In the Direction: box choose “Output” as we want to create a logic output to fire the Denon machine. Finally, in the Function: window scroll down and select “Machine Start”. This is the all-important function that the system will attempt to match up to create our virtual logic connection. It doesn’t matter what the function name actu-

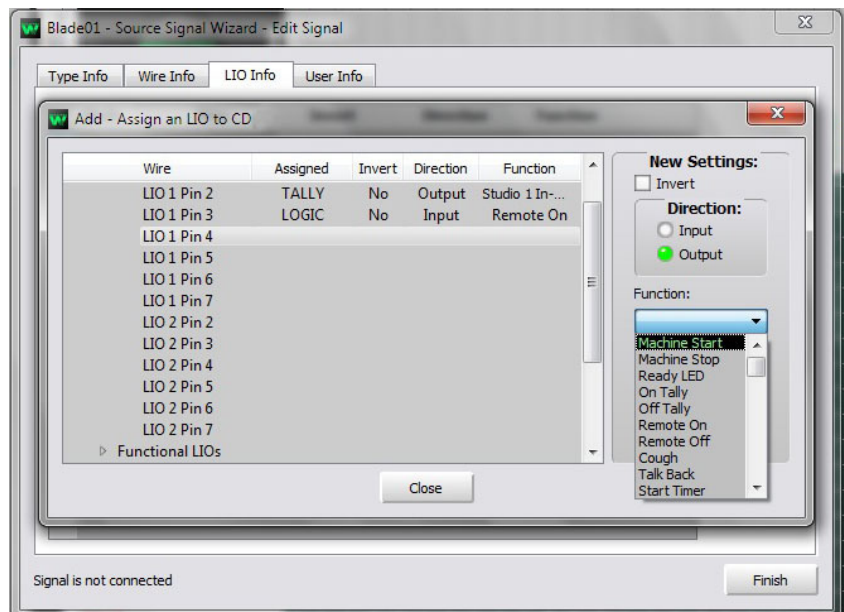

ally is, it's only necessary for there to be a match on the destination side. It makes sense to use the function Machine Start, however, one, because it's a clear, easily understood name, and two, more importantly, the control surface automatically has a Machine Start function mapped on each fader. Click *Apply* and your LIO tab should look like this.

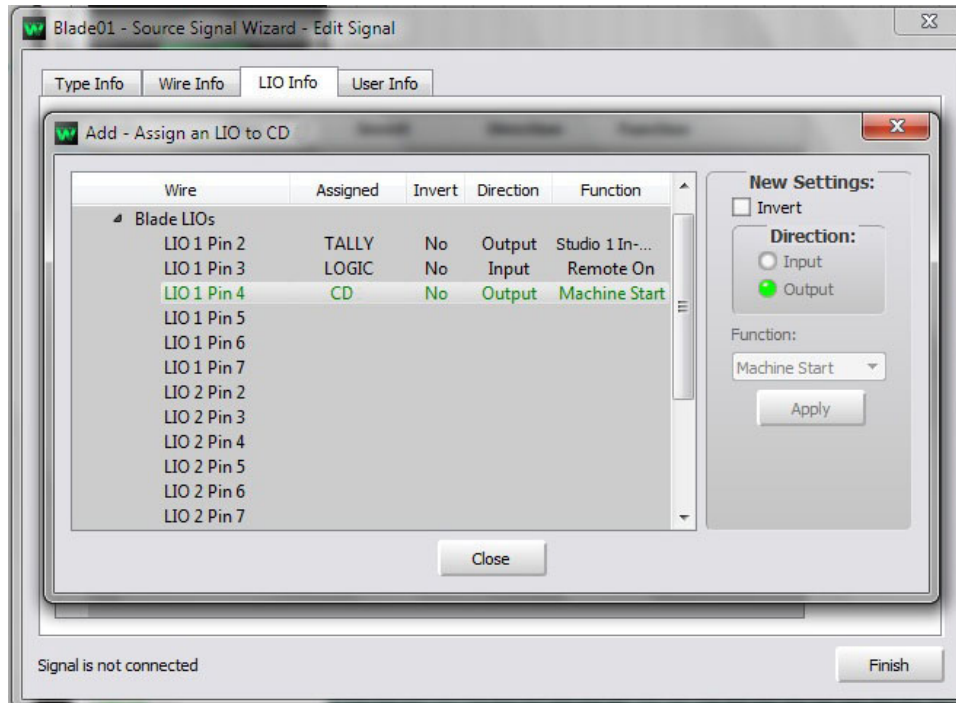

Click *Close* to close the Edit window. Then click *Finish* to exit the Source Signal Wizard. In this fashion, you can map up to 12 different logic functions with each audio signal. Notice also, that you could have mapped this function to a physical logic port in a different BLADE by using the signal tree on the left side of the window. This feature is very useful when you need more than the 12 physical logic ports in the BLADE; just map the logic signals onto another BLADE and wire your logic connections to it. For audio associated logic, the audio signal and the physical logic port can be in different BLADEs.

A further note about logic functions: Just because we have used the Machine Start function here doesn't mean it's all used up and can't be used elsewhere; the complete set of over 500 functions are available for every signal, so you can use Machine Start over and over again. In fact that's what makes audio associated logic so powerful – any signal that has the Machine Start function defined will automatically create the virtual logic connection anytime it is cross connected to any destination signal (say a fader channel) that also has the Machine Start function defined. Just as you need only the one physical wire to connect to the machine logic connector, you need only the one Machine Start function definition to allow any channel of any surface anywhere in the system to exercise Machine Start logic control of the Denon.

To continue with the example: we've wired up the logic connection to the machine and mapped and defined the Machine Start logic function. Let's move over to our control surface and pick a fader channel, say fader #3. Check the source name display above the fader indicating which audio source is currently connected to the destination Fader 3 of the control surface. Make sure it is not the Denon machine. Pushing the channel ON button will turn the fader channel on, but will do nothing as far as the Denon machine is concerned.

In the WheatNet-IP Navigator GUI, locate the destination signal for fader 3 of the control surface and right click on it and choose modify signal to get to the LIO info tab for this signal. You will notice that there is already defined the logic function Machine Start, among others. For future reference, you might want to make note of all of the functions used. By the way, this information is also visible in the Details Pane. Close the window and go back to the crosspoint grid.

Make an audio connection between the source signal “CD1” (the Denon audio signal) and the destination Fader 3 on your control surface. You can use the crosspoint grid, or use the source selector knob on the control surface; it doesn’t matter as long as you make the connection.

Now turn on fader channel #3 and the CD player will start playing! Manually STOP the CD player by pressing its front panel switch. Break the audio connection between the CD player and fader 3 and make a new audio connection between “CD1” and fader #5 and turn that channel on. The CD player STARTs playing audio again, this time over fader #5. This is the power of associated logic; a single physical connection can provide transparent system-wide logic functionality.

You’ll notice that turning the fader channel OFF did not stop the Denon machine; that’s why you had to do it manually. This is because we have only defined the Machine Start function. We will leave the definition of the STOP function as an exercise. Remember, each audio signal can have up to 12 associated logic functions, so there’s plenty of room for STARTs and STOPs and ON TALLYs, etc.

Many of the logic functions needed in a typical radio environment are associated with audio signals. You’ll find the associated logic functionality of the WheatNet-IP system very useful in these situations.

Logic Function Definitions: A large number of function names are defined in the WheatNet-IP system. The functions available at the time of this writing are shown in groups 1 through 8 below, along with descriptions of where and how they are used.

1. These functions are used with audio associated logic. The audio source they are associated with is expected to connect to a surface fader (example: *LXIn01*), which will have a matching pre-programmed function.

Machine Start – Logic output used to start a machine, such as a CD player, when a surface fader is turned on – by default the **Machine Start** function is a latched signal, but can be made to provide a pulse by selecting the *Machine Start Pulsed* VDip option for the associated audio signal in the control surface VDip settings (see the manual for the control surface type you are using)

Machine Stop – Logic output used to stop a machine, such as a CD player, when a surface fader is turned off

Ready LED – Logic input used to control the lighting of the OFF button on the fader to advise the operator of a condition such as a CD player being cued up and ready to play – the machine usually provides an alternating on and off signal so that the OFF button flashes on and off

On Tally – Logic output used to provide a tally of the fader’s ON button to a remote location

Off Tally – Logic output used to provide a tally of the fader’s OFF button to a remote location

Remote On – Logic input used to turn the fader on from a remote location

Remote Off – Logic input used to turn the fader off from a remote location

Cough – Logic input used to unassign the fader from its output bus while a switch at a remote location is pressed, allowing talent at a microphone the chance to cough (or make some other sound) without it being heard on air

Talk Back – Logic input used to assign the fader to the surface cue audio while a switch at a remote location is pressed, so talent at a microphone can talk directly to the board operator

Cue – Logic output that will give you an 1sec closure when the source is put into Cue, and also when the source is brought out of Cue

On Toggle – Logic input used to turn the fader ON and OFF from a remote location.

2. These functions are programmed on logic-only destinations to control the timer on a surface. The logic-only destination must be routed to the surface source signal (example: *LXTIMER* on an LX-24) that has the timer logic pre-programmed on it.

Start Timer – Logic input to start a surface timer from a remote location

Stop Timer – Logic input to stop a surface timer from a remote location

Reset Timer – Logic input to reset (set to zero) a surface timer from a remote location

Hold Timer – Logic input to hold a surface timer at its current setting from a remote location.

3. These functions are programmed on logic-only destinations to interface with the Silence Detect functions. The logic-only destination must be routed to the logic signal that is automatically created when an output is enabled for Silence Detect. See the section on Silence Detect starting on page 5-65 of this manual for more details.

SDet Failure – Logic output to indicate when an output set for Silence Detect is in a failed state; that is, when the primary source fails to provide audio to that output

SDet Mux Pos – Logic output to indicate when an output set for Silence Detect is using its backup audio source

SDet Force Pri – Logic input to force an output with Silence Detect enabled to its primary source

SDet Force Sec – Logic input to force an output with Silence Detect enabled to its backup source.

4. These functions are currently undefined.

Take Preset n (where n = any integer between 1 and 10 inclusive).

5. These functions are programmed on logic-only destinations to indicate when certain sources on the surface have their fader on. The logic-only destination must be routed to the surface source signal (example: *LXTALLY* on an LX-24) that has the tally logic pre-programmed on it. Sources that will trigger the surface tallies are set in the surface VDip settings (see the manual for the control surface type you are using).

Studio n In-Use (where n = any integer between 1 and 12 inclusive) – Logic output – the numbers 1, 2, 3, and 4 correspond to tallies 1, 2, 3, and 4, respectively – use of the remaining values for n is currently undefined.

6. These functions are programmed on logic-only destinations to use with programmable (spare) buttons on a surface. The logic-only destination must be routed to the surface source signal that has the logic for the desired spare button pre-programmed on it. On an LX-24, for example, there are 14 such sources, named (by default) *Spare1*, *Spare2*, and so on, through *Spare14*. Other surfaces may have fewer buttons, and thus fewer sources.

Switch n (where n = any integer between 1 and 14 inclusive) – Logic output to read a spare button. No matter which spare button is used, the function must be **Switch 1**; use of the remaining values for n is currently undefined.

Switch LED n (where n = any integer between 1 and 14 inclusive) – Logic input to light the LED in a spare button. No matter which spare button is being lit, the function must be **Switch LED 1**; use of the remaining values for n is currently undefined.

7. **AES Error $n1$ (1-8)** – For this logic function to work you must click the check box *Enable AES Detection* on the Source Signal Wizard window. This logic output will give a closure if you lose your AES reference on that source.

8. These functions are by design undefined, to be used in any manner desired. They may be associated with audio signals or programmed on logic-only signals as needed, and may be used with input or output logic as required. Keep in mind the master rules of system logic: (1) a logic input must connect to a logic output; and (2) a common function name must be used at both ends of a logic connection.

User n (where n = any integer between 1 and 500 inclusive).

Category 3: Discrete Logic

A third class of logic functions available in WheatNet-IP systems is discrete logic. These are logic functions that work on their own, with no specific association to any audio signals. Typical of these is a situation where a button press in one area lights a light in another, or a satellite receiver detects a tone and closes a relay that is to be used to start a record machine. The WheatNet-IP system can handle this type of logic function very easily. As in the associated logic case, you need only to wire the specific logic connections on your devices to the logic ports on any conveniently located BLADE. All of the control communications between BLADE3s happens over the LAN connection.

As an example let's take the case of a profanity delay DUMP control. We'll assume we have a switch panel located by our talent microphone and we have an airTools-6000 Delay unit located in our rack room. BLADE #1, located in the studio, has available logic ports, as does BLADE #10 located in the rack room. We'll use LIO #7 in BLADE #1 and LIO #3 in BLADE #10. Your system will likely have different BLADE and logic port numbers than these in the example; just substitute your BLADE ID#s as necessary.

To activate the DUMP function the airTools Delay unit requires a momentary closure on pins #7 and #13 of its DB-25 GPIO control connector. First, in the rack room, wire the Delay unit GPIO connector pins 7 and 13 to the first RJ-45 logic connector on BLADE #1, pin #1 and #2 respectively. In the studio you will need to wire the normally open contacts of the DUMP switch to the BLADE #1 pins #1 and #7.

In the WheatNet-IP GUI, you will need to define two new signals for the logic function. You will need a logic source signal, representing the button, and a logic destination signal, representing the DUMP connections on the airTools Delay unit. First click on BLADE #1 in the System Pane of the GUI to open the tab windows for BLADE #1. Click on the Sources tab to open the sources window, and click on the *Add...* button to open the Signal Definition Wizard. Click on LIO only as the signal type and give this new signal a convenient name such as “Dump Sw.”

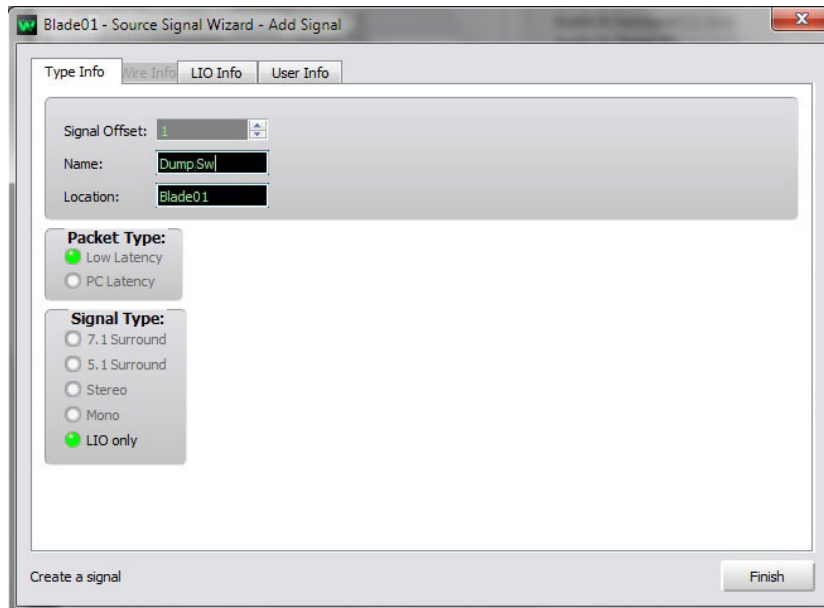

On the LIO Info tab of the Wizard, click on the *Add* box. Click on the “LIO 1 pin 7,” and then select Input in the Direction: box as the logic direction (the DUMP switch will be a logic Input). Finally open the logic function drop down menu and choose a logic function. As mentioned previously, the logic function chosen is unimportant, the requirement is that the device you wish to control must also use the same function. In this case choose “User 1” as the function; you can rename it as “DUMP” if you like. Click *Apply*, click *Close*, then click *Finish*, and the new logic source signal definition is complete.

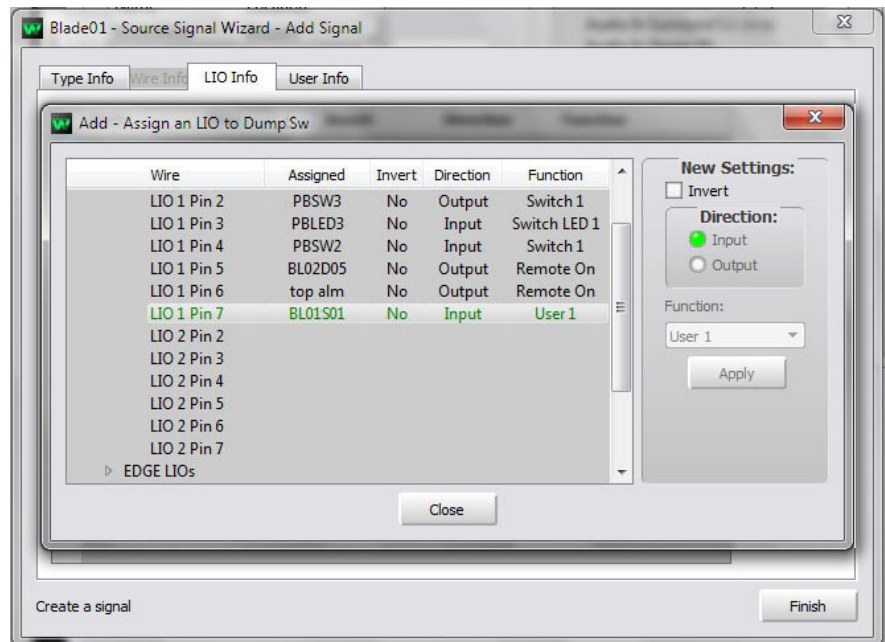

Click on the System icon and Crosspoint tab to open the crosspoint grid; you should see your new “Dump Sw” signal source.

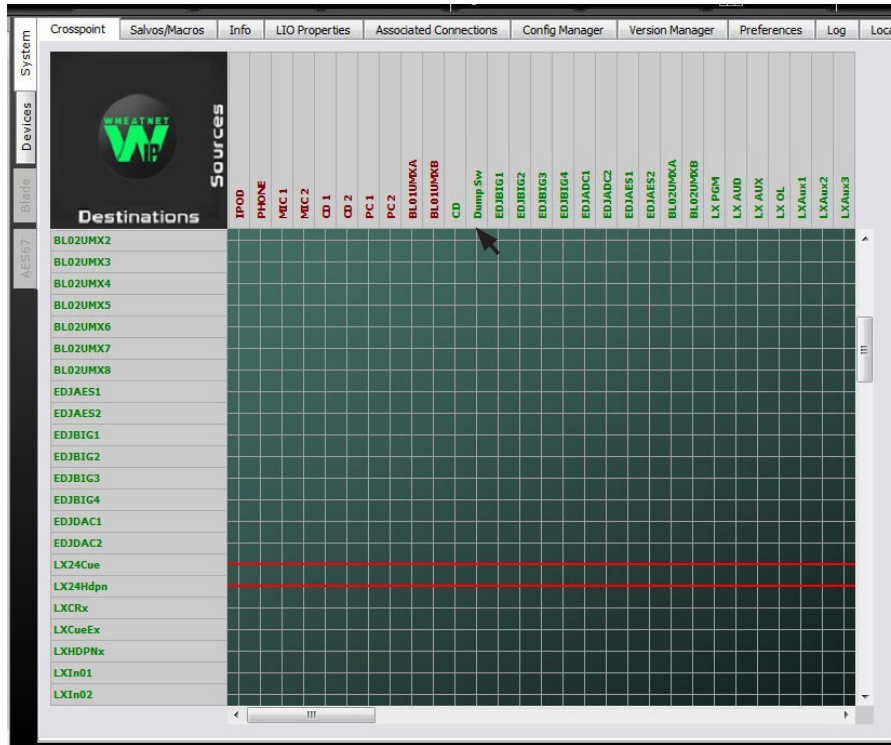

Similarly you need to define a new logic destination signal in BLADE #10. Click on the BLADE #10 icon in the System Pane and select the Destinations tab. As before, click on *Add...*, then select LIO only, to make the new signal, and name it something like “Dump Dev.” On the LIO Info tab of the Signal Definition Wizard, click *Add*, select “LIO 1 Pin 3” to map the logic pin. In the Direction: box select Output for the direction, and finally select “User 1” as the logic function (this is where the logic function must match what you’ve previously defined for the DUMP switch; if these functions do not match, then the logic connection will not work).

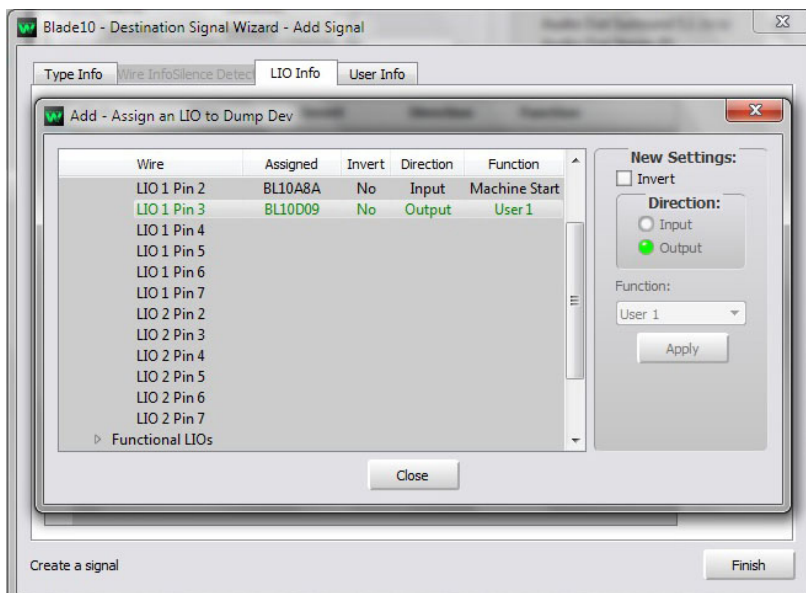

Click *Apply*, then *Close*, then *Finish* on the Wizard, and your new logic destination signal will appear in the crosspoint grid.

To activate and make this logic function operational, you must make a crosspoint connection on the grid between the source “Dump Sw” and the destination “Dump Dev.” Once this has been done, pressing the DUMP switch will create a closure on the logic port of BLADE #10, triggering the DUMP function in the airTools Delay unit. Hint: you can use the WheatNet-IP Navigator GUI to trouble shoot this logic connection. Click on the BLADE #1 icon in the System Pane and click on the LIO Info tab. The window that opens will show the logic signals as they have been defined for the BLADE; you should see your “Dump Sw” shown on line 6. If you have wired and mapped this correctly, the circular indicator in the INPUT column for LIO #7 will change color every time you press the switch. This tells you that the logic input has been wired correctly and is working.

Pin Name	Input	Output	Function	Signal	Fire Salvo	Momentary Co
Blade LIOs						
LIO 1 Pin 2	<input type="radio"/>	<input type="radio"/>	Switch 1	PBSW3	<none>	<none>
LIO 1 Pin 3	<input type="radio"/>	<input type="radio"/>	Switch LED 1	PBLED3	<none>	<none>
LIO 1 Pin 4	<input type="radio"/>	<input type="radio"/>	Switch 1	PBSW2	<none>	<none>
LIO 1 Pin 5	<input type="radio"/>	<input type="radio"/>	Remote On	BL01D05	<none>	<none>
LIO 1 Pin 6	<input type="radio"/>	<input type="radio"/>	Remote On	top alm	Salvo 1	<none>
LIO 1 Pin 7	<input checked="" type="radio"/>	<input type="radio"/>	User 1	DumpSw	<none>	<none>
LIO 2 Pin 2	<input type="radio"/>	<input type="radio"/>	<none>	<none>	Salvo 1	<none>
LIO 2 Pin 3	<input type="radio"/>	<input type="radio"/>	<none>	<none>	<none>	<none>
LIO 2 Pin 4	<input type="radio"/>	<input type="radio"/>	<none>	<none>	<none>	<none>
LIO 2 Pin 5	<input type="radio"/>	<input type="radio"/>	<none>	<none>	<none>	<none>
LIO 2 Pin 6	<input type="radio"/>	<input type="radio"/>	<none>	<none>	<none>	<none>
LIO 2 Pin 7	<input type="radio"/>	<input type="radio"/>	<none>	<none>	<none>	<none>
Software LIOs						
Surface 1 Spares						
EDGE LIOs						

Likewise, if you click on the BLADE #10 icon and LIO Info tab, you should see the “Dump Dev” logic signal shown on line 2. Again, if defined correctly and crosspoint connected to the “Dump Sw” signal, the circular logic status indicator will change color when you press the DUMP switch, showing activation of the logic signal at the output port on the BLADE.

All discrete logic functions are defined and configured the same way. Once you’ve made a few of them work to get comfortable with the process, it’s easy. Just remember the fundamentals:

- Define the source and destination signals and map them to the logic ports you’ll use.
- Choose a matching pair of logic functions.
- Make a crosspoint connection between the source and destination signals (note, if you want to, you can lock this connection just as you can audio signals).

Category 4: Action Logic

This fourth class of logic function in the WheatNet-IP system includes system events such as Salvos and Momentary Connections. Action logic is intended to force crosspoint connection changes. Perhaps you have an Air studio that undergoes a major change in signal connections when the morning show finishes. Instead of having the talent go through and change all the source and destination connections individually at each shift change, you could create a Salvo that makes all of the required changes at once. Furthermore, you can use a logic connection to a button to fire the Salvo itself, so all that your operator needs to know is to push the button at shift change. What could be easier?

For an example, let's assume you have created a Salvo to change out your studio configuration from Morning Drive to your 10 o'clock show, and you've cleverly called it "10AM." You are planning to use a switch panel in your studio to fire the Salvo, and you're going to wire the "10AM" switch on the switch panel to logic LIO 2 port #2 on BLADE #1.

Here's how to do it: First wire up the normally open terminals of the switch to pins #1 and #2 on the second RJ-45 logic port of BLADE #1. In the WheatNet-IP Navigator GUI, click on the icon for BLADE #1 in the System Pane, and then click on the LIO Info tab. On LIO 2 #2 (the 7th line) double click on the Fire Salvo box to open the window and click on the "Fire Salvo" check box. In the drop down window, scroll and select the "10AM" Salvo and click on the *OK* button.

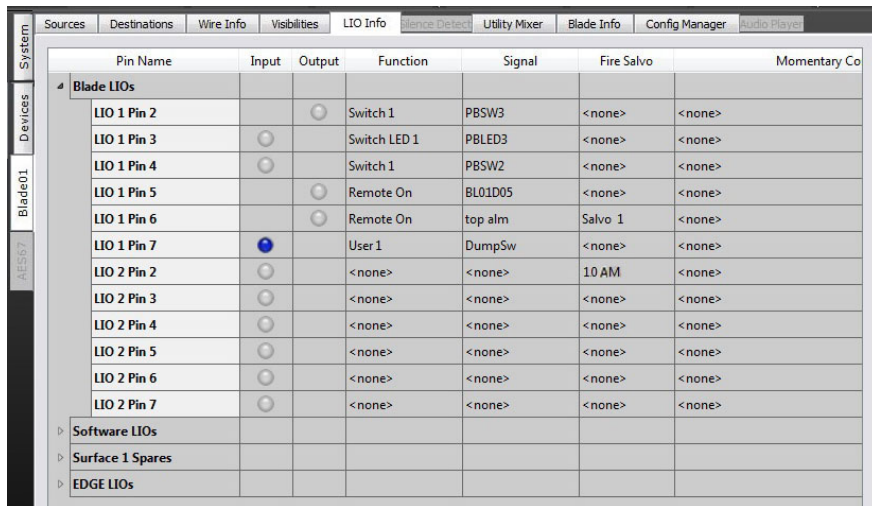

Pin Name	Input	Output	Function	Signal	Fire Salvo	Momentary Co
Blade LIOs						
LIO 1 Pin 2		<input type="radio"/>	Switch 1	PBSW3	<none>	<none>
LIO 1 Pin 3	<input type="radio"/>		Switch LED 1	PBLED3	<none>	<none>
LIO 1 Pin 4	<input type="radio"/>		Switch 1	PBSW2	<none>	<none>
LIO 1 Pin 5		<input type="radio"/>	Remote On	BL01D05	<none>	<none>
LIO 1 Pin 6		<input type="radio"/>	Remote On	top alm	Salvo 1	<none>
LIO 1 Pin 7	<input checked="" type="radio"/>		User 1	DumpSw	<none>	<none>
LIO 2 Pin 2	<input type="radio"/>		<none>	<none>	10 AM	<none>
LIO 2 Pin 3	<input type="radio"/>		<none>	<none>	<none>	<none>
LIO 2 Pin 4	<input type="radio"/>		<none>	<none>	<none>	<none>
LIO 2 Pin 5	<input type="radio"/>		<none>	<none>	<none>	<none>
LIO 2 Pin 6	<input type="radio"/>		<none>	<none>	<none>	<none>
LIO 2 Pin 7	<input type="radio"/>		<none>	<none>	<none>	<none>
Software LIOs						
Surface 1 Spares						
EDGE LIOs						

To test this out, switch to the crosspoint grid view of the GUI and watch the crosspoints switch on the grid as you press the switch (be sure to do this at a safe time as you will actually be switching audio and can mess up a show On-Air).

You can also use action logic to make a crosspoint change (hint: use a Salvo of one signal) that switches the source for a destination, or to make a temporary crosspoint change that substitutes a source to a destination for as long as the button is held down. The latter is particularly useful in Talkback/Intercom types of situations.

Appendix 4

Contents

External Controllers

A-49

External Controllers

The WheatNet-IP audio networking system has been designed to work with a growing family of external hardware and software controllers. These controllers allow for a wide range of control functions, from making a single crosspoint to complex condition control scripts. There are hardware based controllers such as the Wheatstone HBX8 hot-button controller, the Wheatstone XYC controller, and the GP-8P and GP-16P programmable controllers. There are software controllers such as PC-XY and the Event Scheduler, and control applications by various Automation System providers ranging for Enco and OMT to Crestron and AMX.

All of these controllers integrate with WheatNet-IP by means of an Ethernet connection to the system; no physical GPI/GPO or serial cable wiring is required.

Wheatstone provides a separate software utility called the WheatNet-IP XYC control GUI for setting up and configuring the hardware controllers provided by Wheatstone. This password protected application allows you to set up the controller, map it to the desired control destination(s), set up its operating modes, and organize the signal visibility for the controller.

This image shows a typical set up screen from the control GUI.

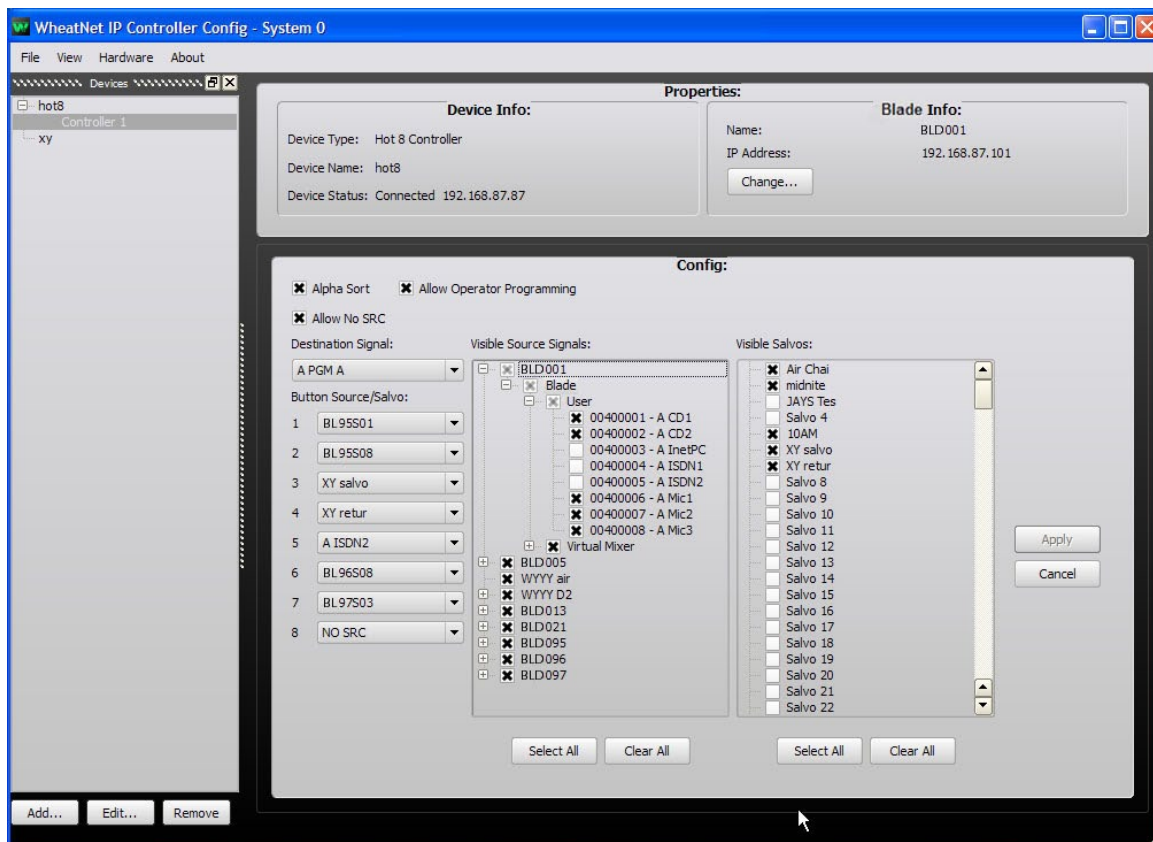

The WheatNet-IP XYC control GUI is provided with the purchase of any of the Wheatstone hardware controllers.

For software based controllers please refer to the documentation provided with the software package, or contact techsupport@wheatstone.com for more information.

Appendix 5

Contents

WheatNet-IP WDM Driver Installation	A-51
Hardware Requirements.....	A-51
Software Requirements.....	A-51
Installation	A-51
Application Note.....	A-54c
Configuration.....	A-55
System Parameters	A-55
Software License.....	A-55
Removing the Drivers	A-57

WheatNet-IP WDM Driver Installation

This technical document is intended to give you general information about installing the WheatNet-IP WDM Driver. This driver is network based using TCP/IP. It is recommended that a second network card be installed in the PC. The first Network Interface Card can connect to your audio playout system network or other useful network as desired. The second card will be used to connect to the WheatNet-IP Network.

Hardware Requirements:

Standard PC (Intel or AMD, 32 or 64 bit platform) with the following:

- 100 Base T or 1000 Base T network interface card configured to run in full duplex mode (1000 Base T speed is preferred).
- USB Security Dongle (see page A-54b) optionally required for driver operation. If using the USB Security Dongle, do not install it on the PC until after the driver installation has completed.

Software Requirements:

The WheatNet-IP driver has been designed to run under the Windows Operating system.

The following are the minimum requirements:

- Windows XP with SP 2
 - Requires Wheatnet-IP Driver installer package specifically for Windows XP.
- Windows 7
- Windows 8
- Windows 10

NOTE: XP specific installer package will not work on Windows 7 and up Operating systems.

Installation

To install the driver, locate the setup files on the CD received with the WheatNet-IP system, or contact Wheatstone support for the current release version.

Windows should be logged in as a user with Administrator rights. In addition depending on how the PC is setup, you may additionally need to right click the installer package and select “Run as Administrator” even though you are logged in with Administrator rights.

Make sure no Audio applications are running at this time.

Run the Setup_x.x.x.exe application (x represents the version of the current release).

1. Read the License Agreement and release notes before proceeding. Then click *I Agree*.

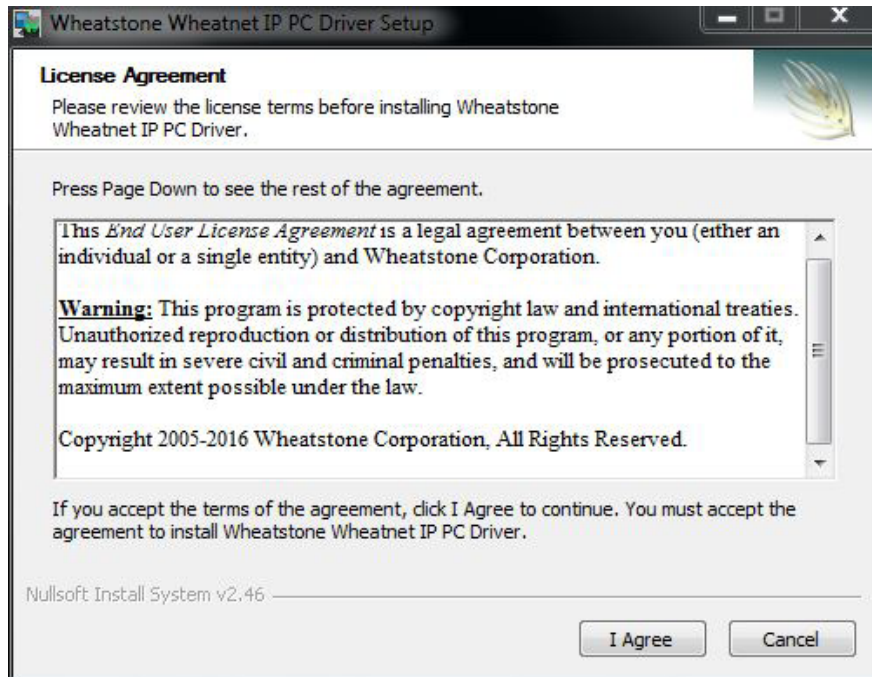

2. If you have a previous version of the driver installed, the Installer runtime will attempt to uninstall this old version.

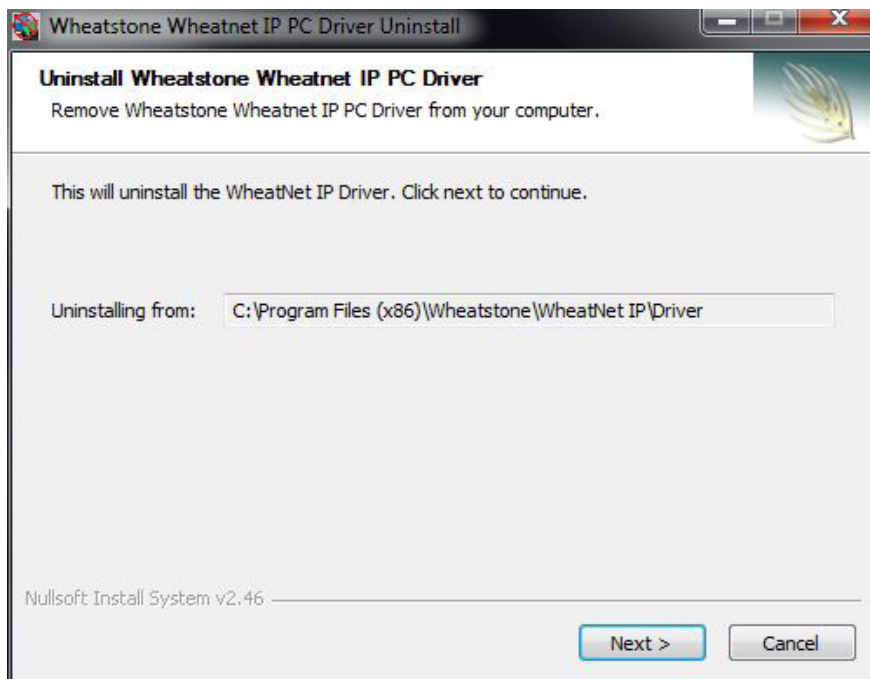

3. If removal of the previous version was successful the Install runtime will display the following success message. Click *Close* to continue.

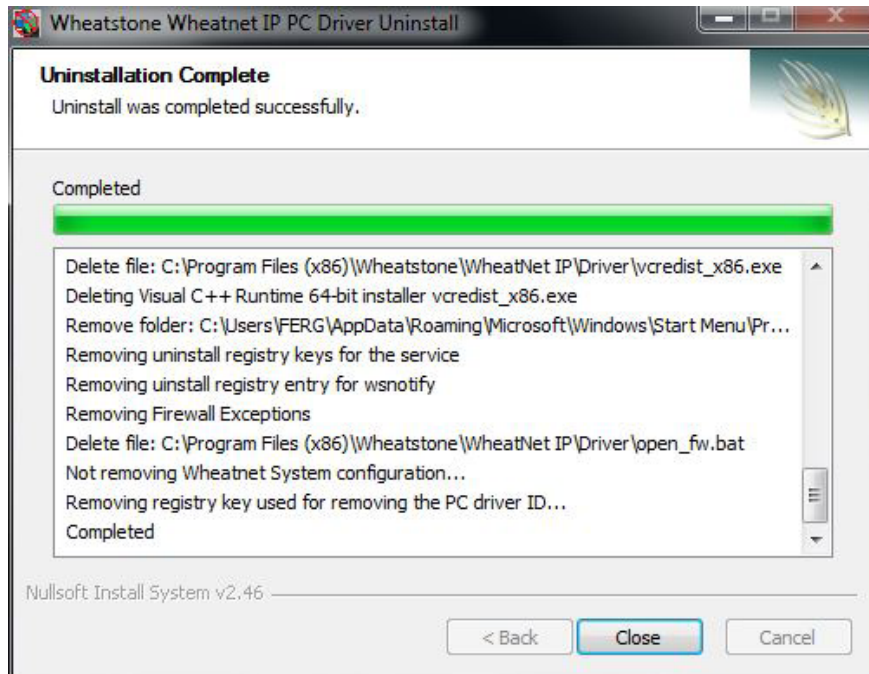

4. Next select the installation options (defaults are recommended).

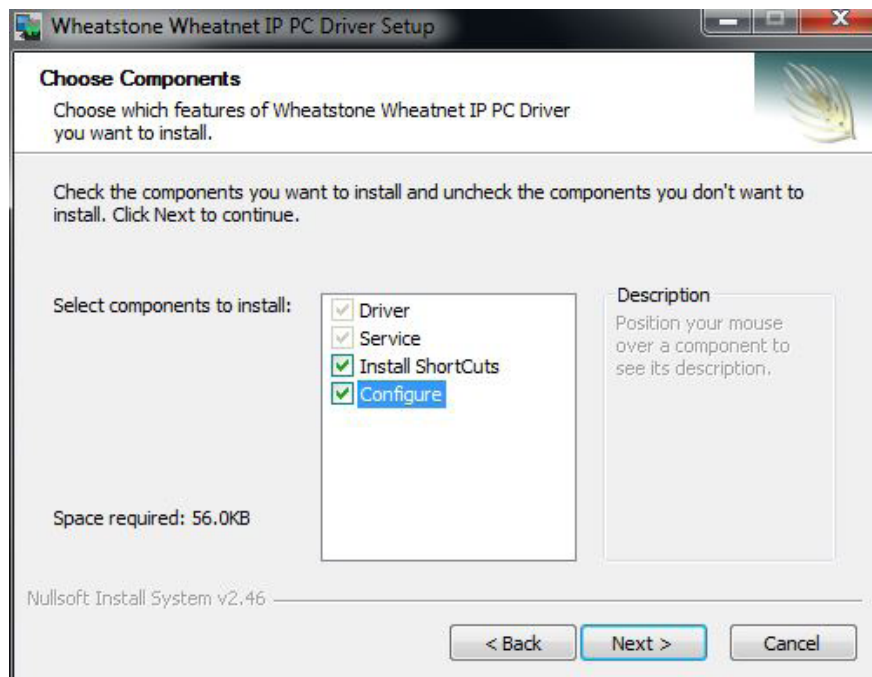

- Choose the folder in which to install the WheatNet-IP PC Driver files. Using the default destination folder is recommended. If required, select a new destination folder by using the browse button. Navigate to the desired location and press *OK*. Once your destination folder has been selected, click *Install* to proceed. During this process you will see several DOS windows appear. This is normal as firewall and port settings are being configured by the installer.

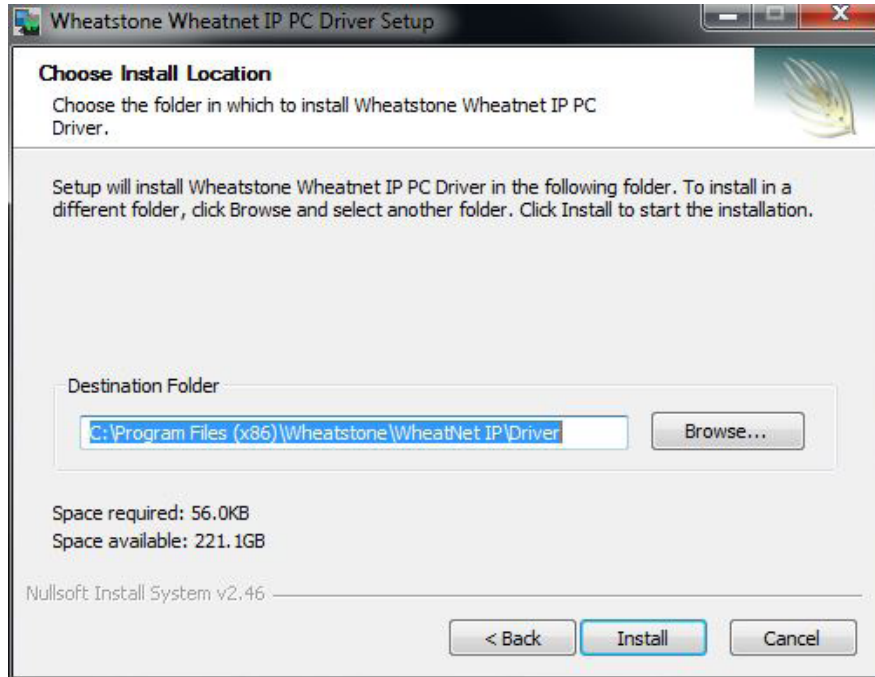

- Next you will see the installation process begin.

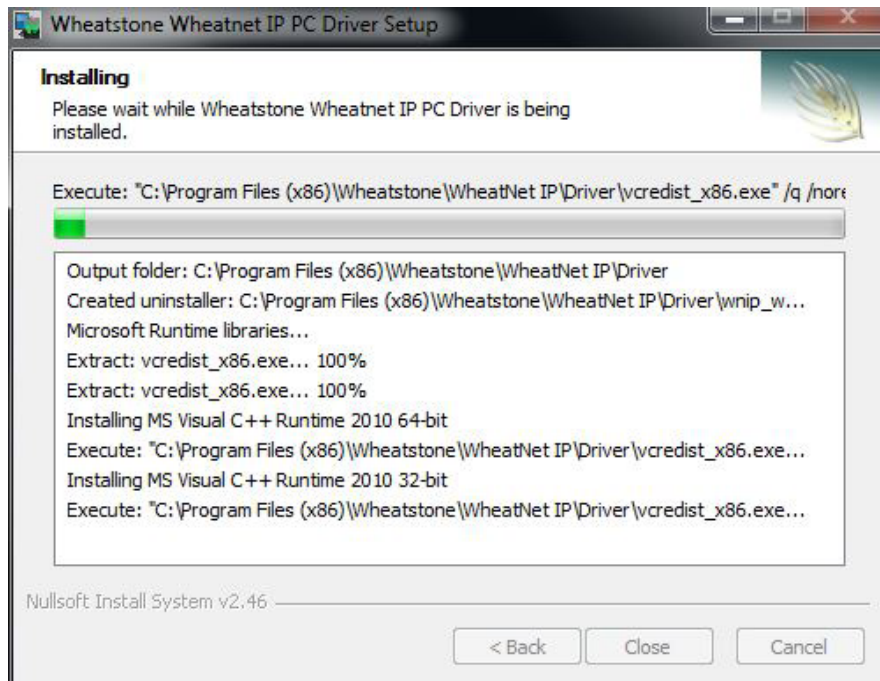

7. During the file copy process you will be prompted with a Windows security message asking if you would like to install the Keylok drivers. If you are using a USB Security key license, please click *Install*. If you have been provided a software license, please select *Don't Install*.

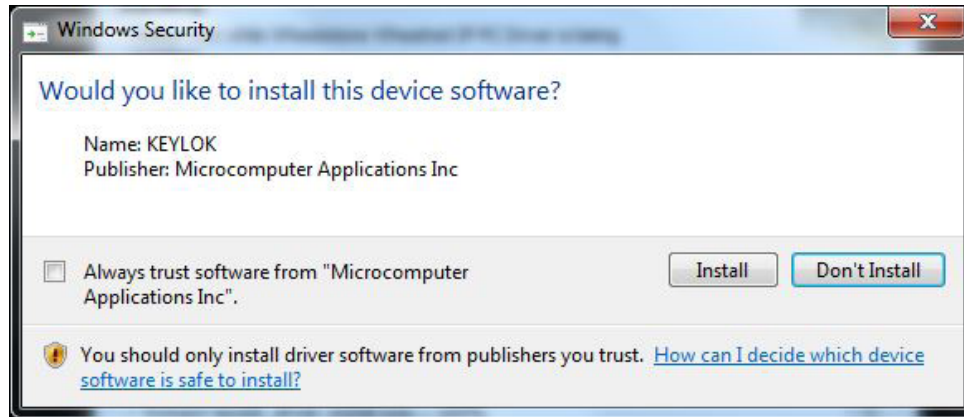

8. If you choose *Don't Install* you will be prompted with this message. Click *OK* to continue.
9. At the end of the Installation, you will be shown the Configure WheatNet-IP control panel. You can configure the necessary settings here to add the PC Driver to the BLADE system. We will cover configuration later in this document. Click *OK* to continue.

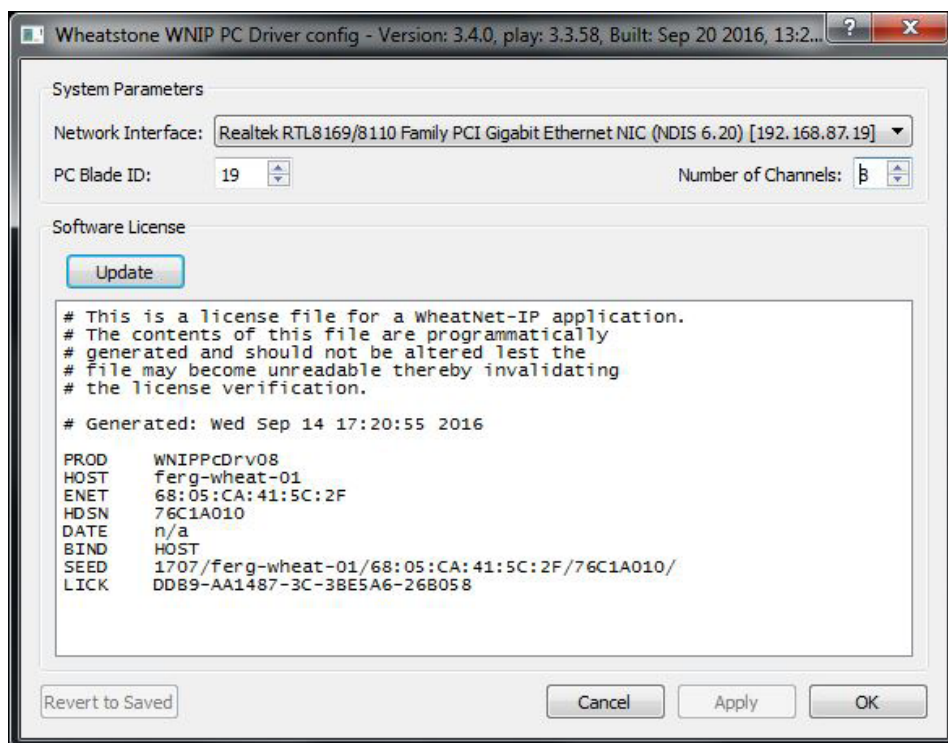
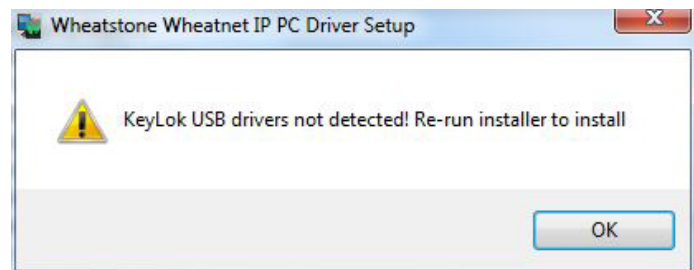

10. Once you have dismissed the Configuration screen, you will be returned to the status screen as shown below. Click *Close* to complete the Installation runtime.

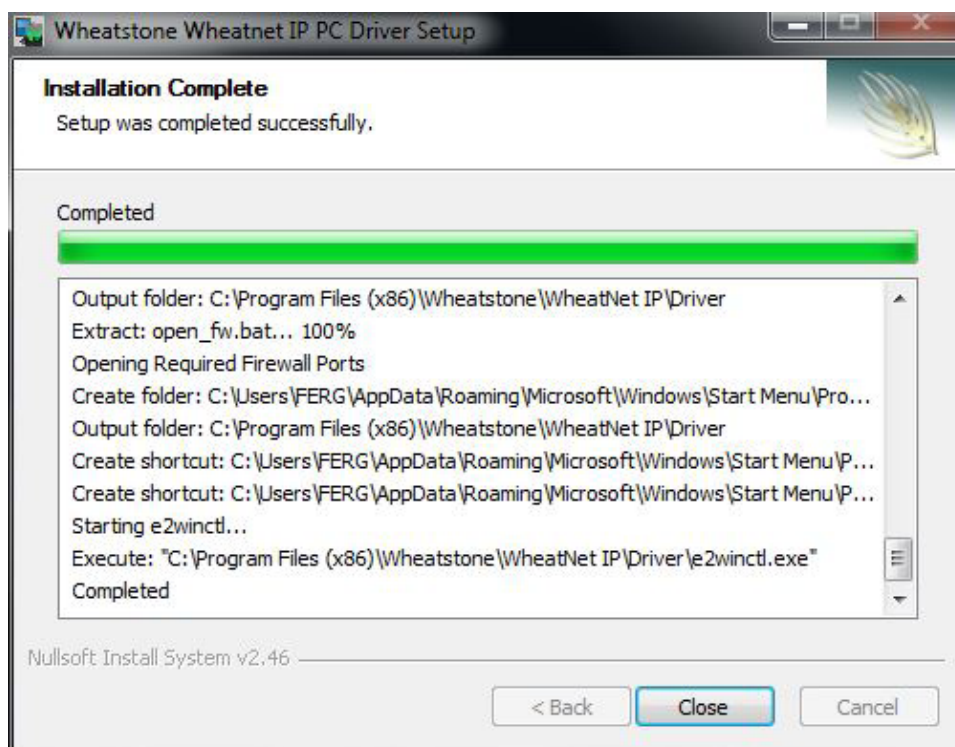

11. At this point, if you are using the Keylok USB security key, you can physically install it to an available USB port on the PC. Windows will discover the device and load the Keylok drivers you installed earlier. If for some reason the Keylok drivers did not install, you can simply run this installer package again to install them.
12. If you are using a "Software" license, you will need to provide to Wheatstone support a Seed Key. This is accomplished by running the WNIP Driver config and clicking on the *Request Button*. Copy the information provided and paste into an email to support@wheatstone.com. In the email also state the number of channels for each Seed Key provided.
13. Once you have the USB Key Installed or received and applied your Software Key, and click *Apply* in the WNIP Driver Config application you will get a notification that the License is found and it will report the number of Channels licensed for.

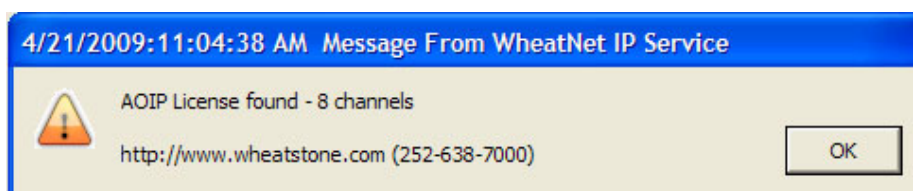

14. If you are presented a message that the License cannot be found, please revisit the steps above to ensure that the USB Key and Driver are installed or that your Software License Key has been applied.

Application Note:

When starting the Wheatstone WNIP Driver Config application, you may be presented with an error message that suggests the driver is not properly installed. If you are presented with this message, you can acknowledge the message by clicking *OK*, then perform the following steps.

1. Open the working folder for the Wheatnet IP Driver: *C:\Program Files (x86)\Wheatstone\Wheatnet IP\Driver*
2. Find the file called *e2winctl.exe*, right click and select *Properties*
3. Click on the *Compatibility* Tab
4. Select *Run this Program as Administrator*
5. Click *Apply* then *OK*.

Now when you access the WNIP Driver config application you will not be prompted with that message.

Configuration

The Wheatnet-IP Driver Control Application will allow you to setup the required parameters for the driver. Here you will configure the unique BLADE ID of the PC Driver, along with choosing the Network Interface, and the number of Channels licensed for. Depending on the version you purchased you could have 1,4, or 8 stereo channels available.

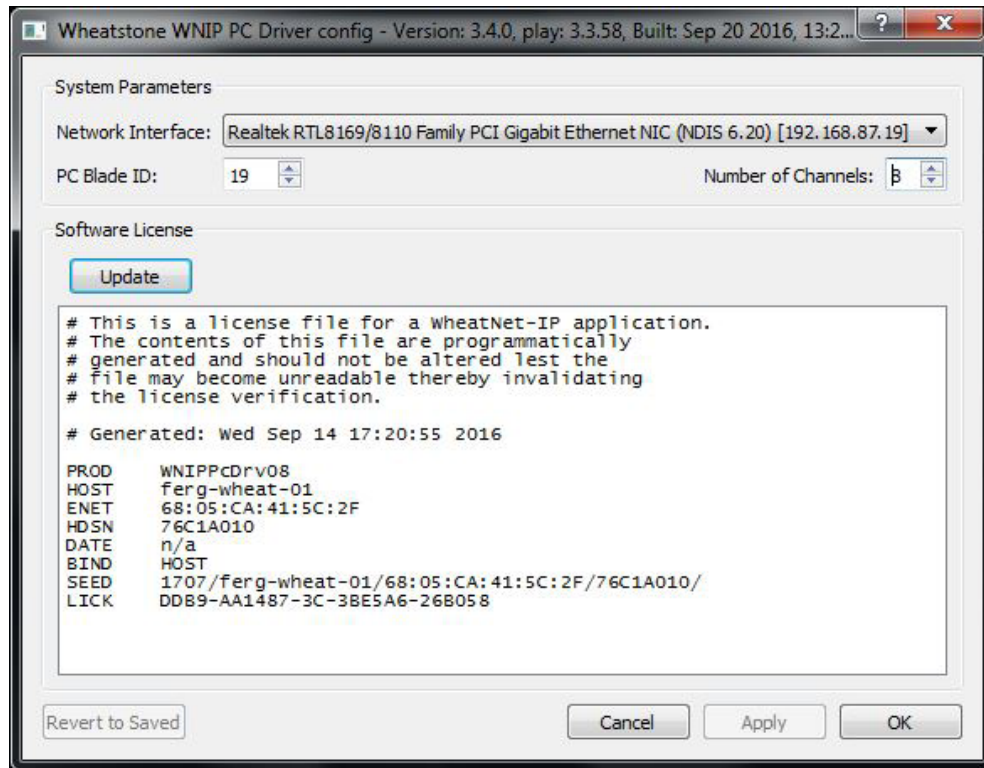

System Parameters

- **Network Interface** – This control is used to select a specific network interface card to use for the Wheatnet-IP network. If you have multiple Network Interface Network cards, use this dropdown to select the appropriate card, which is also displayed with the card description.
- **PC Blade ID** – This is used to set the device or BLADE ID in the WheatNet-IP systems. Each BLADE in the system must have a unique BLADE ID, including WheatNet-IP Drivers.
- **Number of Channels** – Use this control to match the number of channels you purchased with your license.

Software License

- If your screen shows a button labeled *Request* (instead of *Update*), and you **Do Not** have a USB Key installed, please click the *Request* button and generate a Seed Key to send to Wheatstone support. In addition to the Seed Key, indicate the Number of Channels purchased with this license. Note you can provide multiple Seed Keys at time. Wheatstone support will return to you license keys to apply to each PC using the *Apply* or *Update License* from this application.

- If your screen shows a button labeled *Request* and you **DO** have a USB Key installed, you **DO NOT** need to request a license key. The USB Key is providing the license.

Note that both the *Apply* and *OK* controls will need to re-start the driver for the changes to take effect. The application will attempt to restart the driver for you. If the system is unable to restart the driver, you will be prompted to reboot the computer. You may choose to reboot the computer even if the driver restarts. Once the PC is rebooted you should see it in the list of BLADE 3s in the Navigation GUI.

The configuration application and PC WheatNet-IP utility (if installed) are available under the start menu. All of the WheatNet-IP driver related programs are grouped under **Start>All Programs>Wheatstone>WheatNet IP**.

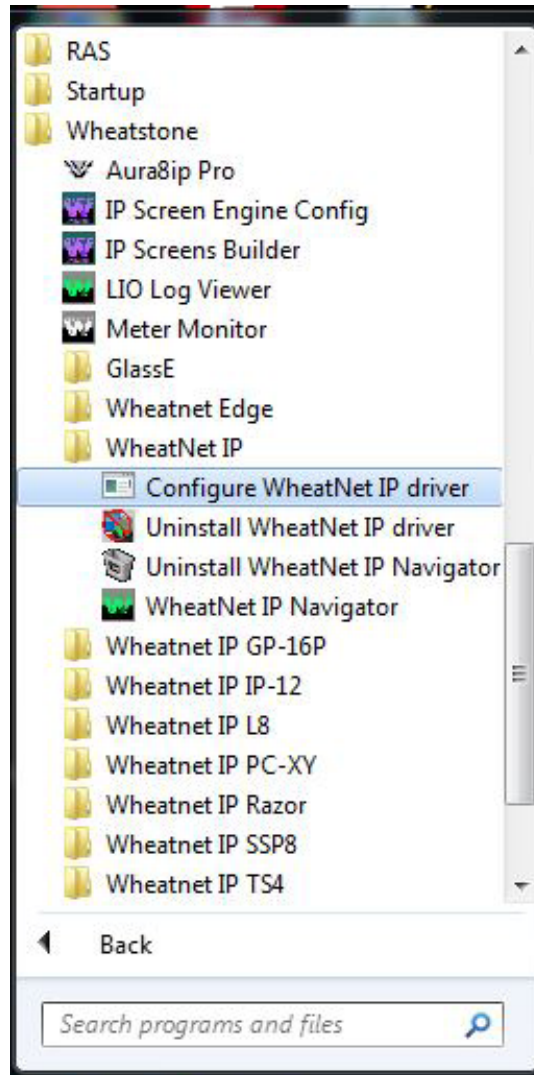

Removing the Drivers

To uninstall the Wheatnet-IP driver you should run the Uninstaller package from *Start > Programs* or *All Programs > WheatNet IP > Uninstall WheatNet IP Driver*.

You will see a message confirming the successful removal of the WheatNet-IP driver. Click *Close* to Exit.

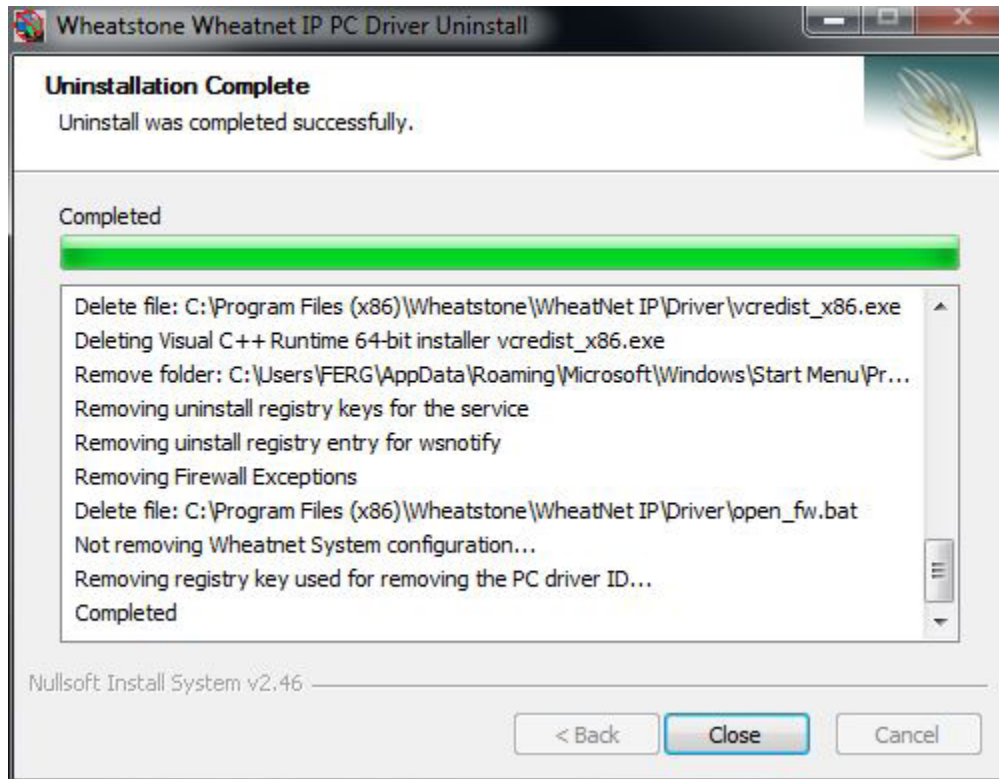

Appendix 6

Contents

IP-MTR64 Meters GUI	A-59
Introduction To IP-MTR64 Meters GUI	A-59
IP-MTR64 Meters GUI Overview	A-59
IP-MTR64 Meters GUI Features	A-59
Installation	A-60
Requirements	A-60
Performing The Install	A-60
Adding The IP-MTR64 Meters GUI To The Peripheral Devices Tab	A-63
Program Operation - Getting Started	A-64
License Key	A-64
First Time Operation	A-65
Network Setup	A-65
“Discovering” The System Components	A-67
Setting Up Meters	A-69
Configuring A Meter Cell	A-69
Using The Analysis Window	A-70
Changing The Meter Layout	A-70
Configuring Silence Detect Alarms	A-71
Security Settings	A-73
Setting The Password	A-73
Operating With Security	A-73
Making The Security Settings	A-73
Menus	A-74
View	A-74
Layout	A-74
WheatNet-IP System	A-74
Setup	A-74
Additional Popup Menus	A-75
Summary	A-75

IP-MTR64 Meters GUI

Introduction To IP-MTR64 Meters GUI

Get a quick read of any audio source, destination or stream in your WheatNet-IP Intelligent Network. Our IP-MTR64 Meters GUI app displays a “wall of meters” on your computer screen for ongoing monitoring of audio peak levels and average levels at selected points throughout the entire network. Included is a separate FFT meter for spectral readings plus visual alerts should a channel go dark.

IP-MTR64 Meters GUI Overview

In today’s connected world of AoIP, it’s nice to know what’s going on with your audio. Not just the audio at local sources and destinations, either, but all audio at every point in your network. You could haul out all that expensive test gear for a look, but who has time for that? It’s much easier to drop in an app like our new IP-MTR64 Meters GUI for the WheatNet-IP network, which gives you ongoing metering of audio levels, signal density, FFT readings – the works.

Fully customizable, the IP-MTR64 Meters GUI lets you display an almost limitless array of metering and analysis on the monitor of any computer connected to the WheatNet-IP Intelligent Network. Plus, meters have silence detection, so you can see at a glance if an audio stream has gone down, and where.

Each meter – or cell – in your IP “wall of meters” can be set up as a horizontal, vertical or eyebrow bargraph meter. You can set up two or 20 or 60 or more cells in one “wall.” You determine where and what to meter: console inputs, mic outputs, the satellite receiver, studios, web streams, you name it. In addition, a separate analysis window allows you to view one audio stream in a variety of informative ways, including FFT, 3-D plot, oscilloscope, energy vs. frequency, spectral dynamic range, and more.

Meters are arranged in a grid layout with the number of individual cells and the size and location of analysis windows you want. Style of metering can be curved, horizontal or vertical bargraph (you determine the number of bars) for mono or stereo, and for reading peak levels, average levels and peak over average levels. Set up one or two bright VU or PPM meters for instant loudness verification of on-air studios from across the room, for example, and add five or 10 or 30 side meters for checking levels of players and mics feeding those studios. Size, background color and text labeling for each cell is fully customizable by you. One meter at a time can be zoomed to a full-screen view for detailed observation. Multiple layouts, complete with source selection, metering choices, colors, labels, and analysis settings, can be saved and recalled for use in various situations.

IP-MTR64 Meters GUI Features

- Multiple bargraph meters in one computer display for checking levels of any source, destination or audio path in a WheatNet-IP network
- Separate analysis window for detailed signal evaluation using FFT, 3-D plot, oscilloscope, energy vs. frequency, spectral dynamic range, and other tools
- Real-time metering of audio peak levels, average levels and peak over average levels; stereo or mono
- Two to more than 60 meter cells in a single display screen

- Style of metering can be curved “eyebrow,” horizontal or vertical bargraph (you determine the number of bars)
- Silence detection/failover at a glance for alerting you if an audio stream has failed
- Customizable as an overall grid layout of meters with color options and font selections for metering in a way that makes sense to you.

Installation

The IP-MTR64 Meters GUI software is distributed as a Windows executable installer file, *WnetIP_MeterGui_x_x_x.exe*, where the *x_x_x* part gives the version number. Double-click this file’s icon to begin the installation.

Requirements

For small system the IP-MTR64 Meters GUI software does not have a heavy requirements list. It will install on any modern computer with a Windows 2000 through Windows 7 operating system.

In systems larger than 15 BLADEs the computer should have at least a dual core processor and a minimum 4 GB of RAM.

Performing The Install

Double-click the installer file’s icon to begin the installation and see the following screen:



Click *I Agree* to accept the End User License Agreement.

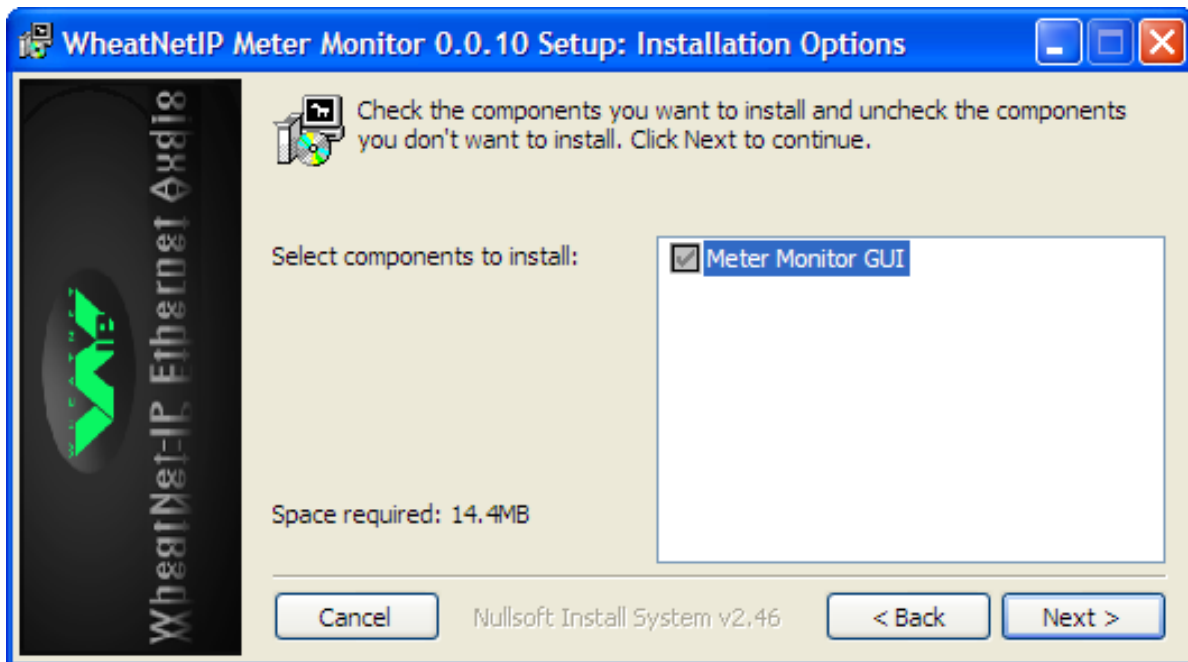

Click *Next*.

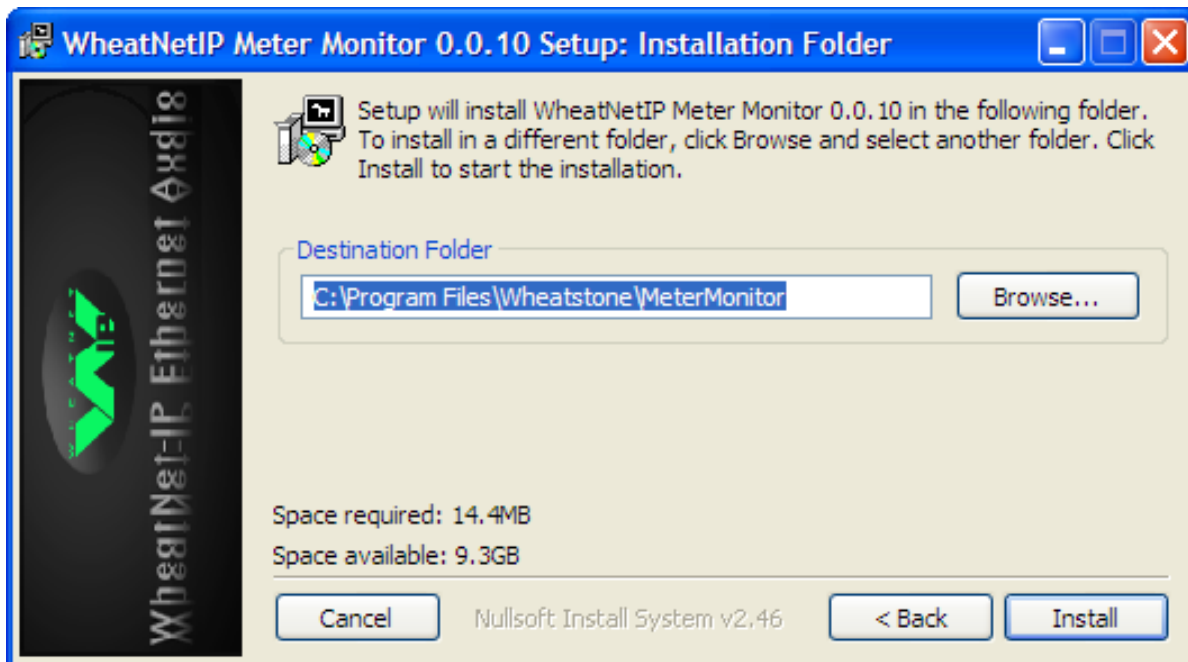

Click *Install*.

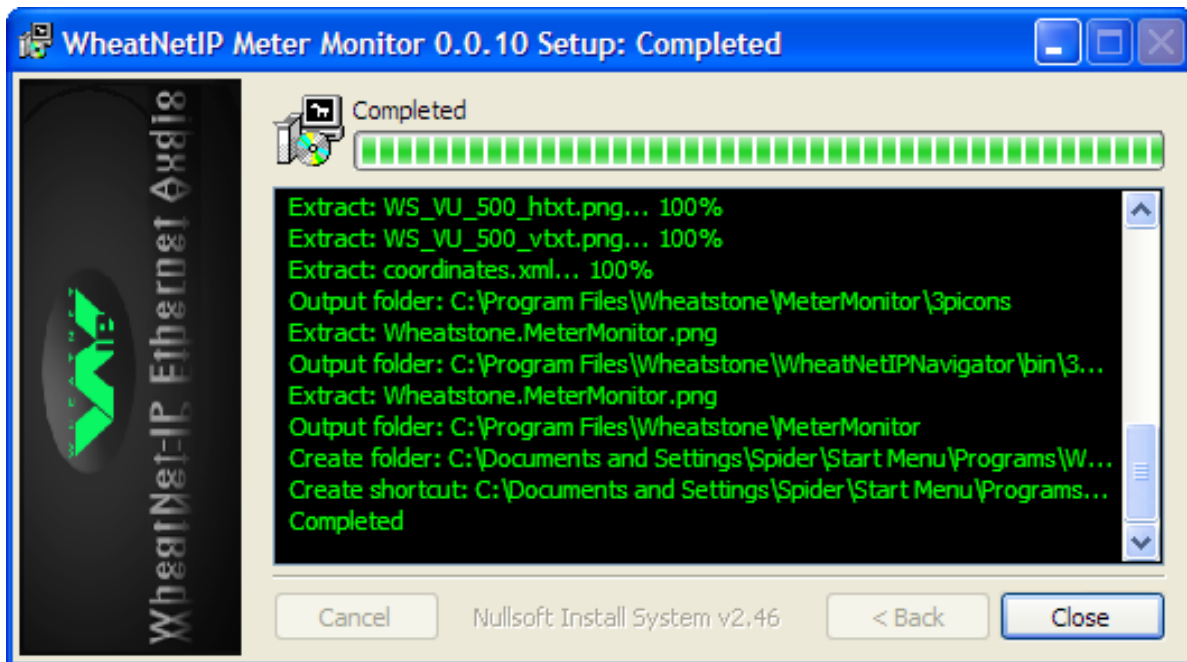

Click *Close* to complete the installation. An icon will appear on your desktop that you can use to start the IP-MTR64 Meters GUI program.

The program is installed by default to

C:\Program Files\Wheatstone\MeterMonitor\WheatNetIpMeterGui.exe

or in Windows 7 to

C:\Program Files (x86)\Wheatstone\MeterMonitor\WheatNetIpMeterGui.exe

and can be launched from the Start menu, where it will appear in the Wheatstone group.

Adding The IP-MTR64 Meters GUI To The Peripheral Devices Tab

In order to utilize all the features of the IP-MTR64 Meters GUI the device must be added to the *System Peripheral Devices* tab in the Wheatstone WheatNet-IP Navigator program (aka the Navigator GUI). This sheet shows you the basics of that procedure. Refer to the *WheatNet-IP Audio Over IP Network Technical Manual* for additional details.

You will need to know the IP address of the device being added, so you will want to find that out before you start.

Launch the Navigator GUI and make sure that **System** is selected in the *System* pane. You will see something like this:

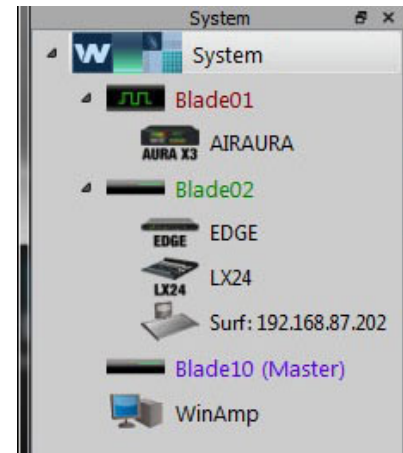

Now select the *Peripheral Devices* tab.

System	Surfaces	Peripheral Devices	AES67 Devices	ACI Devices	GBT Cards					Add...	
Devices	Launch	Status	Device	IP Address	Port	Host Blade	Id	Vendor	Product	Edit...	Remove
	Launch	●	L8	192.168.87.201	60021	L8-CB	1	Wheatstone	L8		
	Launch	●	TS4H	192.168.87.220	60021	LXE Eng	1	Wheatstone	TS4P		
	X	●	Meters	192.168.87.19	60021	AURA8	1	Wheatstone	MeterMonitor		

Click the *Add* button to bring up the *Add Peripheral Device* dialog:

Give the device, which in this case is actually the IP-MTR64 Meters GUI program, a convenient *Name*. Enter the *IP Address* of the **computer on which the meter application is running**. Leave the *TCP Port* at the default setting of **60021**. From the *Host BLADE* drop down select the BLADE that you want to the Peripheral device with. Click *Ok*.

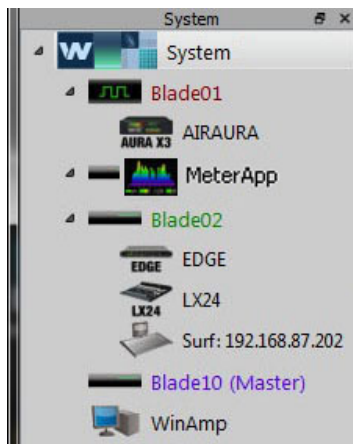

You should now see an icon for the meter application in the *System* pane under the BLADE you added it to, and its characteristics should show up on the *Peripheral Devices* tab.

If it does not show up, or if it shows up but has a yellow question mark on it, then there is either a network issue that needs attention, or the device is not connected to the network at all, or one or more steps have been omitted or done incorrectly in the configuration process.

Program Operation – Getting Started

First time operation of any software is a learning experience. You will want to be on a computer that's connected to a WheatNet-IP system when starting the program the first time. Note that the computer must have an IP address on the same subnet as the WheatNet-IP system hardware.

License Key

The first time you start up the program you will be asked for a license key.

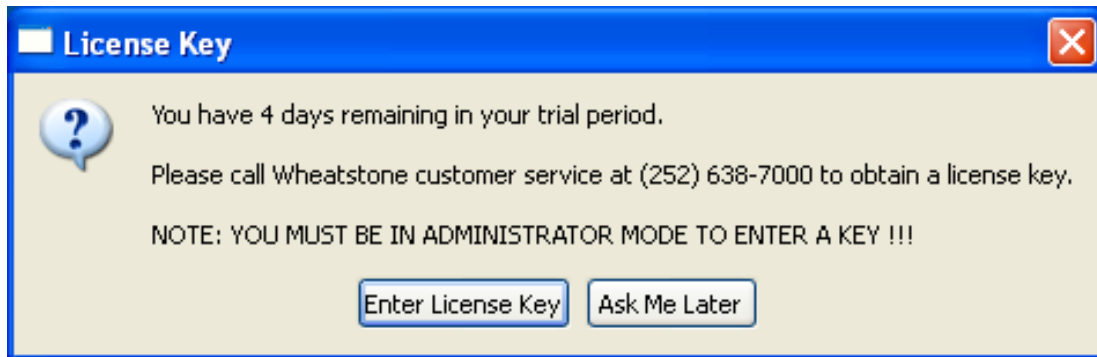

If you wish to run the software beyond the seven day trial period you will need to purchase a site license for the program from your Wheatstone Corporation sales representative.

To continue without entering a license key click *Ask Me Later*. Each time you restart the program without having entered a valid license key you will again be prompted to enter one. In our example screen shot above there are four days remaining in the trial period. After the seven day trial period is over the nag screen will no longer give you the option of continuing unless you enter a valid license key.

If you have a license key to enter, click *Enter License Key* to bring up the screen on the right:

Enter the license key that you obtain from Wheatstone Technical Support and click *OK*. The following screen appears when a valid license key has been entered:

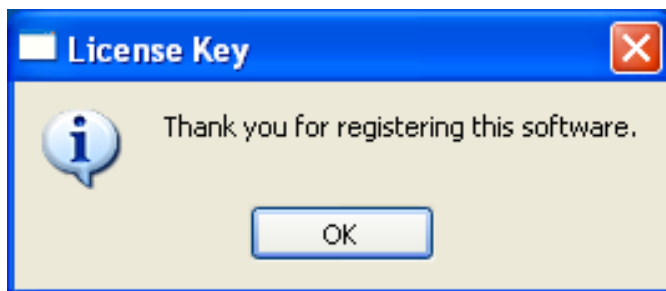
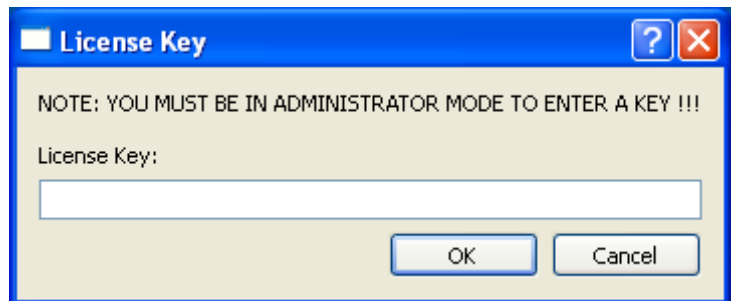

Click *OK* and the program will open in full screen mode.

First Time Operation

The first time you start up the program you will need to do some basic setup. The program opens in full screen mode. For convenience the following screen shots are made with the screen resized. Here's the opening screen:

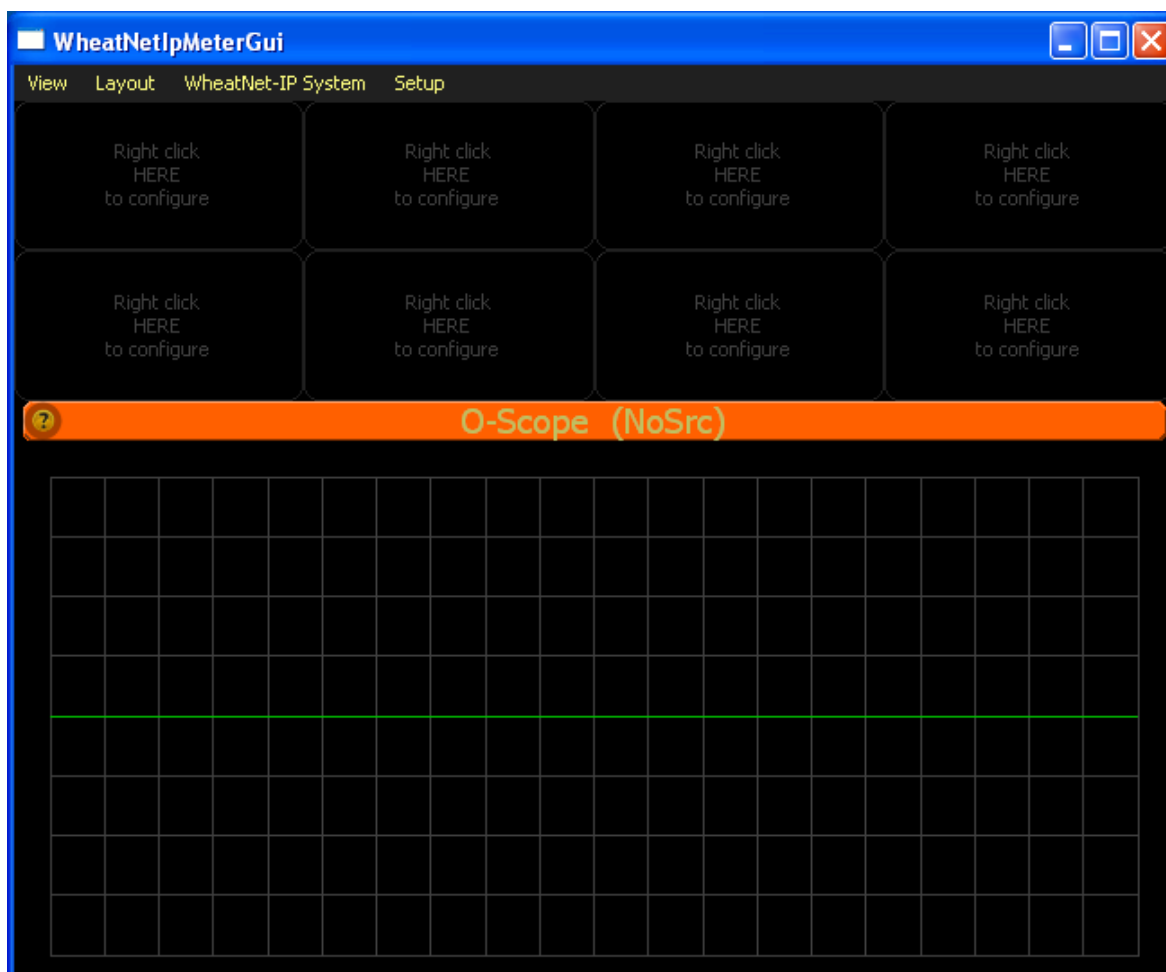

Network Setup

Select *Setup>Network...* from the menu to bring up the *Network Setup* dialog:

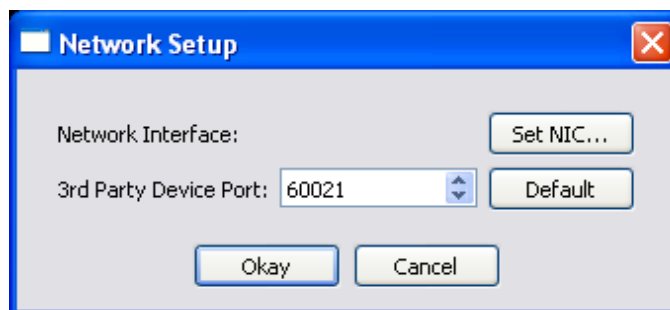

Click the *Set NIC...* button and select the NIC that interfaces to the WheatNet-IP system from the drop down list:

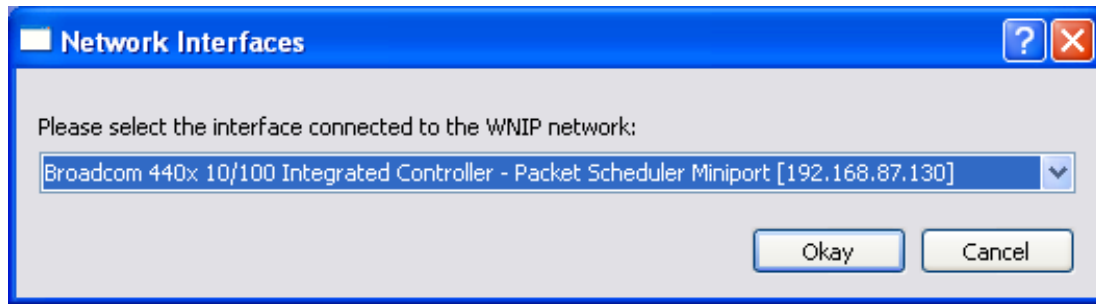

Click *Okay*. Leave the *Peripheral Device Port*: setting at the default. Click *Okay*. You will see a notice that you will need to restart the program for the changes to take effect.

Click *OK*, then close the program and restart it.

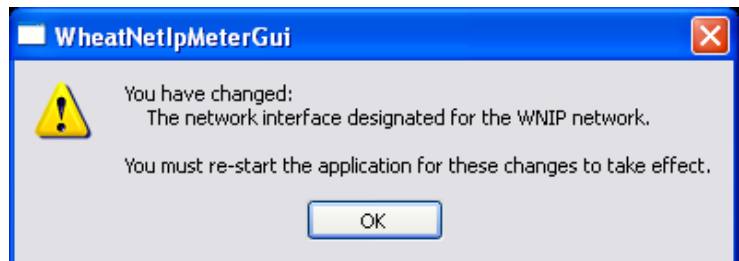

Note that the computer must have an IP address on the same subnet as the WheatNet-IP system hardware.

“Discovering” The System Components

The IP-MTR64 Meters GUI will need to gather some information from the system. From the menu, select *WheatNet-IP System>System Scan...* to start the process.

In the *Host BLADE IP Address:* field, enter the IP address of one of the BLADEs in the system and click the *Start Scan* button. The data display area will start to fill with data from the system. When the scan is complete the data display area’s last entry will be “Ok”, and the *Cancel* button will change to become a *Finish* button.

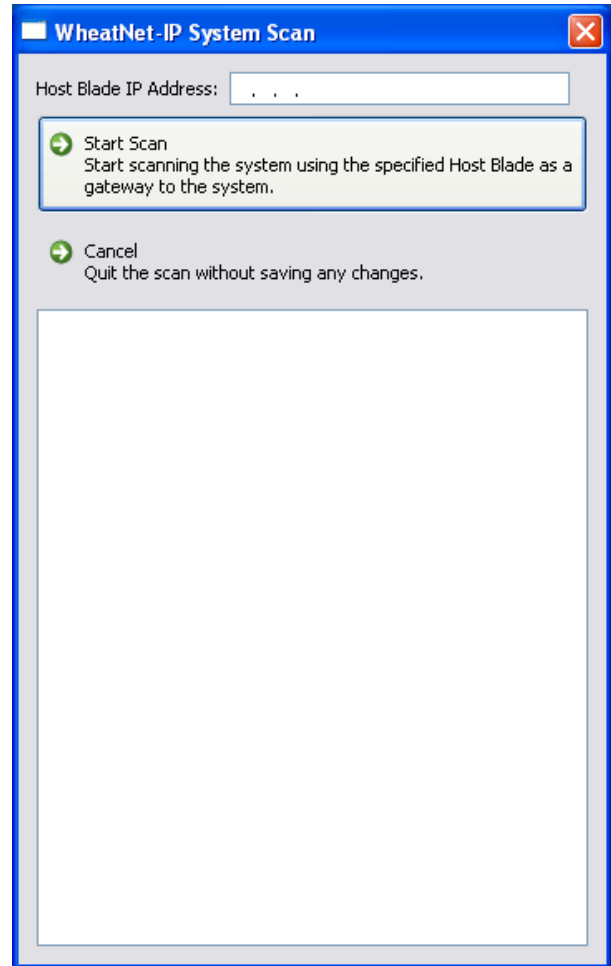
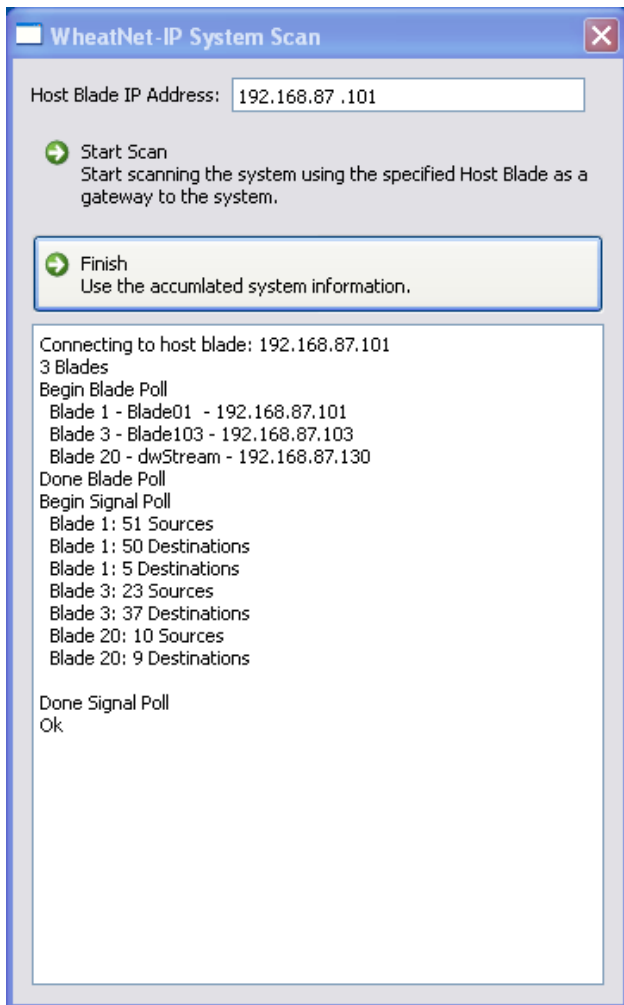

If you make any changes to the system you will need to redo the scan and re-save the scan results to keep the Meters GUI program up to date.

Click *Finish*. You’ll be asked if you want to save the system information to disk. Doing so will insure that the program uses the data the next time it is started. **However, if you make any changes to the system you will need to redo the scan and re-save the scan results to keep the Meters GUI program up to date.**

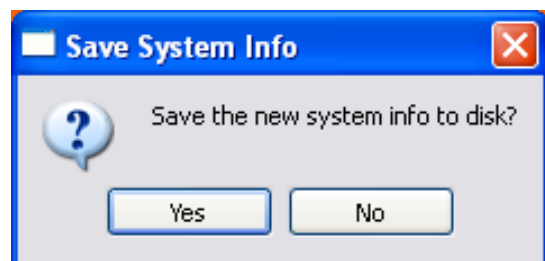

If you click *Yes* a typical Windows file save dialog will appear. Select the desired location and give the file a name, then click *Save*.

Any time you want to see the current system information the program is operating with, select *WheatNet-IP System>View Info...* - the *WheatNet-IP System Information* screen will appear:

ID (hex)	ID (dotted)	Name	Location
00400001	1.0.0.1	EAS 1A	Blade01
00400002	1.0.0.2	EAS 2	Blade01
00400003	1.0.0.3	BL01503	Blade01
00400004	1.0.0.4	TALLY	Blade01
00400005	1.0.0.5	DoClose1	Blade01
00400600	1.0.3.0	BL01UMXA	SN MXE1
00400601	1.0.3.1	BL01UMXB	SN MXE1
00400602	1.0.3.2	BL01UMYA	SN MXE1
00400603	1.0.3.3	BL01UMYB	SN MXE1
00410000	1.1.0.0	E6PgmA	SN MXE1
00410001	1.1.0.1	E6PgmB	SN MXE1
00410002	1.1.0.2	E6PgmC	SN MXE1
00410003	1.1.0.3	E6PgmD	SN MXE1
00410400	1.1.2.0	E6Aux1	SN MXE1
00410401	1.1.2.1	E6Aux2	SN MXE1
00410402	1.1.2.2	E6Aux3	SN MXE1
00410403	1.1.2.3	E6Aux4	SN MXE1
00410600	1.1.3.0	E6BM01	SN MXE1
00410601	1.1.3.1	E6BM02	SN MXE1
00410602	1.1.3.2	E6BM03	SN MXE1
00410603	1.1.3.3	E6BM04	SN MXE1
00410604	1.1.3.4	E6BM05	SN MXE1
00410605	1.1.3.5	E6BM06	SN MXE1
00410606	1.1.3.6	E6BM07	SN MXE1
00410607	1.1.3.7	E6BM08	SN MXE1
00410800	1.1.4.0	E6MM1	SN MXE1
00410801	1.1.4.1	E6MM2	SN MXE1
00410802	1.1.4.2	E6MM3	SN MXE1

Comments:
C:/Program Files/Wheatstone/MeterMonitor/meter-gui-system-map.wnsi2

When done viewing this screen click the red 'X' icon in the upper right corner to close the window.

Setting Up Meters

Until you start working with the meters you see a default layout with no working meters. So let's get a meter playing.

Configuring A Meter Cell

Right-click in the first meter cell and select *Configure...* from the popup menu.

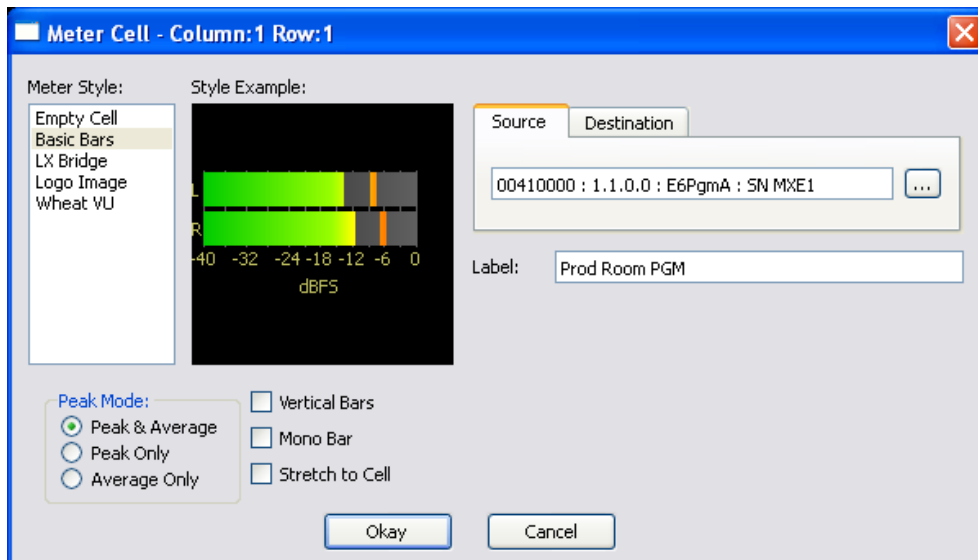

Change *Meter Style:* to **Basic Bars**. Now pick a signal from your system that you want to display. First choose either the *Source* or *Destination* tab, depending on which signal type you want to display, then click the set button (labeled with three dots) and double-click the desired signal name in the list that appears. Give the meter a descriptive *Label:* and keep the other settings at their defaults. Click *Okay*.

You should see the meter running in the first meter cell, and it will show any audio present on that signal.

If you right-click on the same meter cell and select *Zoom In...* from the popup you will see that individual meter cell in a full screen display. Right-click in the full screen display and select *Close* in the popup to go back to the normal view.

Note that you can also configure a meter cell to show a graphic, such as a station logo, or even a picture of you, or your boss, or even a pet.

Go ahead and configure a few more cells. Here's the standard layout on a typical system with a few meters configured:

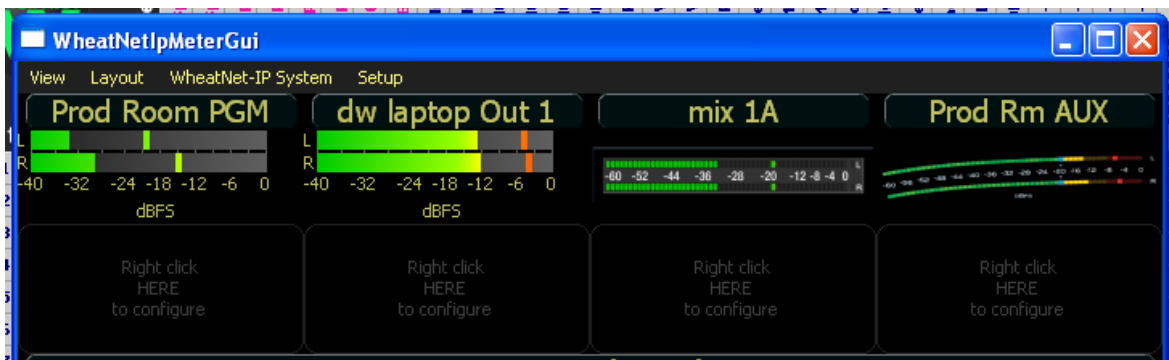

Using The Analysis Window

The first step in using the analysis window is to select the audio you want to view. For reasons that will be mentioned below, this must be a source signal. You will not be able to select a destination directly for analysis.

Right-click in the analysis window and select *Take Source...* from the popup. Find the desired source and double-click it in the list to present that source to the analysis window. The analysis window will now show the source's audio in the presentation format selected, which is *O-Scope* by default.

Right-click again in the analysis window to change the presentation format. Select the desired format from the popup. Go ahead and experiment with the available formats to determine which one you want to use for the task at hand.

Once you have selected the desired presentation format, right-click one more time in the analysis window and select *Configure...* from the popup. You will be presented with a number of choices to alter the analysis view. The configuration choices will be different for each display format.

As mentioned above, you can only select sources to analyze. This is because the audio being analyzed is streamed to the computer from the host BLADE via the meter analysis destination signal that was created when the application was set up as a Peripheral device. By default, this destination is named **Anlys A** and appears as a destination on the host BLADE that was selected for the meter application.

Changing The Meter Layout

So far we've been working with the default meter layout. Select *Layout>Configure...* to bring up the *Meter Cell Layout* dialog to edit this layout. The *Simple* tab shows a gallery of layout starting points.

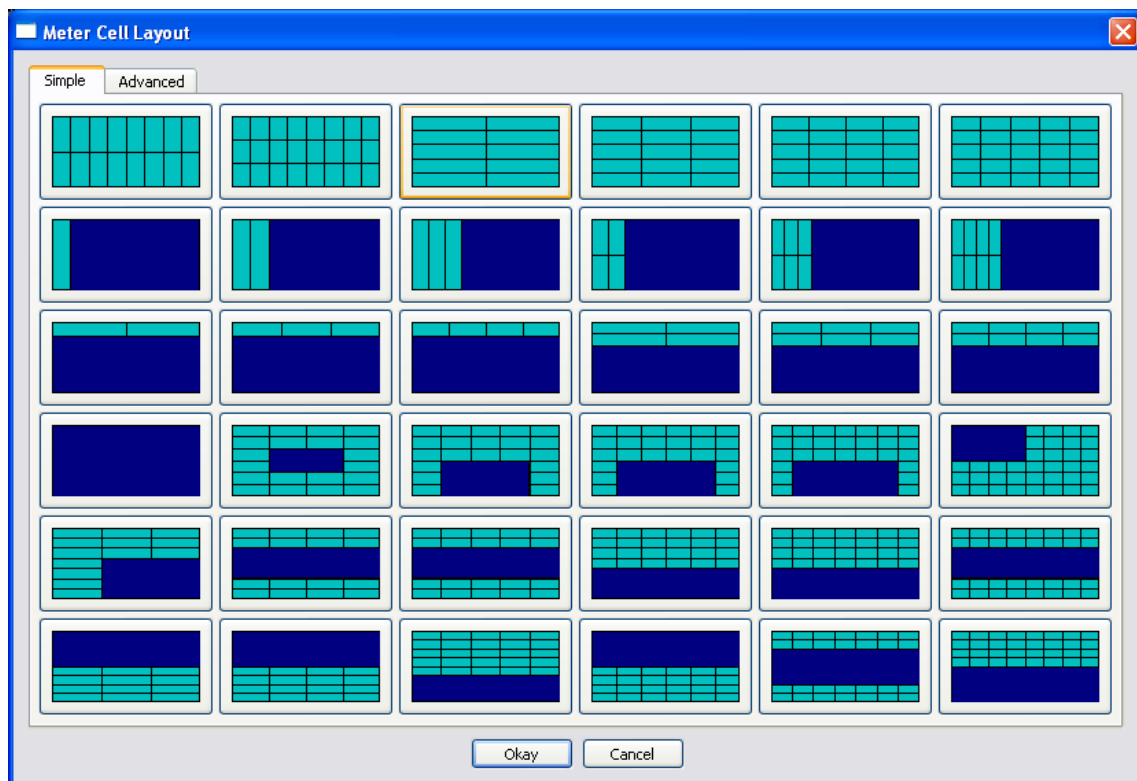

If you don't find a layout here that suits your needs, switch to the *Advanced* tab.

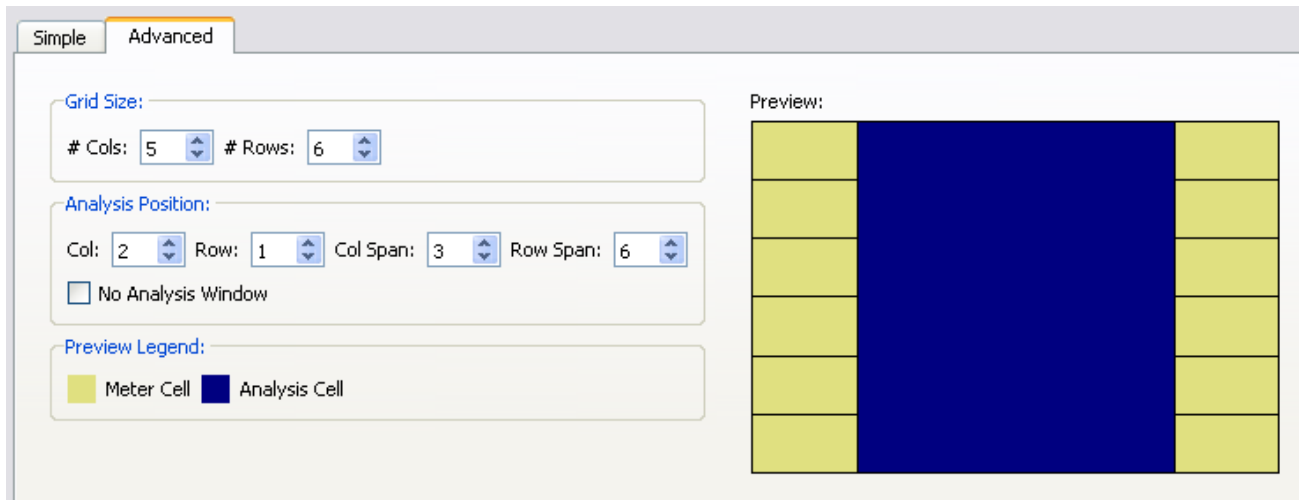

There you'll find a way to set up almost any layout you could want. Begin by selecting the number of *Cols*: (1 through 16) and *Rows*: (1 through 16). Then set up the analysis window by selecting the starting *Col*., the *Col Span*: (width), the starting *Row*., and the *Row Span*: (height).

Check the *No Analysis Window* box if you don't want an analysis window.

You can also invoke the layout dialog by selecting *Layout>New*. This is the starting point to use when creating a new layout, whereas *Layout>Configure...* is primarily used to edit an existing layout.

You can save layout changes by selecting *Layout>Save* or *Layout>Save As...* from the menu. Note that the *Save* option saves your changes to an existing file (setup.wnmtr by default), but the *Save As* option brings up a typical save dialog and allows you to create a new file, or save to an existing file, so you can have a library of layouts for different applications. To load a previously saved layout, select *Layout>Open...* and select the desired file.

Configuring Silence Detect Alarms

The IP-MTR64 Meters GUI can give you a visual cue when a destination with silence detection enabled does not have audio on it. It is assumed here that you have at least one destination in your system configured for silence detect. Look in the “WheatNet-IP Navigator GUI” chapter of this manual for details on how to configure silence detect.

Configure a meter cell to display a destination that is configured for silence detect. As long as there is audio on that destination within the silence detection parameters set up for the signal, it will display like any other meter cell of the same type.

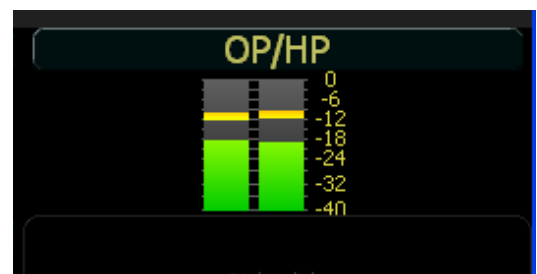

But if the audio on that destination goes away long enough to trigger the WheatNet-IP silence detect, and if there is no failover audio present, the display will change to indicate an alarm condition. The orange label indicates the alarm, and the meter shows no audio.

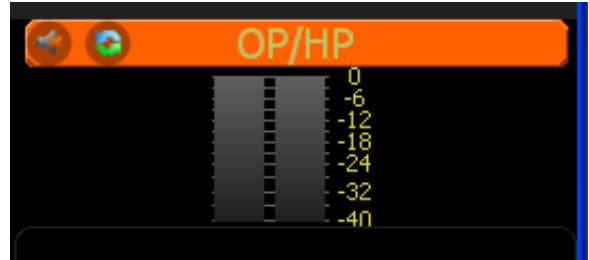

Alternatively, if the audio on that destination has gone away but there **is** failover audio present, the display will be different; the orange label will still be there, but the meter will show the presence of the failover audio.

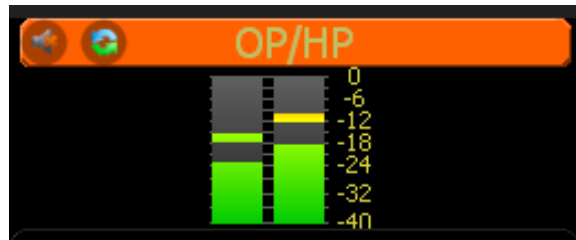

The alarm color, like several other layout colors, can be changed by selecting *Setup>Preferences...* from the menu.

Double-click on the alarm label and a log will pop up showing you what silence detect activity has transpired since the log was last cleared.

This log window can also be invoked by right-clicking in the meter cell and selecting *Alarm Logs...* from the popup menu.

Click *Okay* to close the log window. Clicking *Clear Logs* removes all entries from the window.

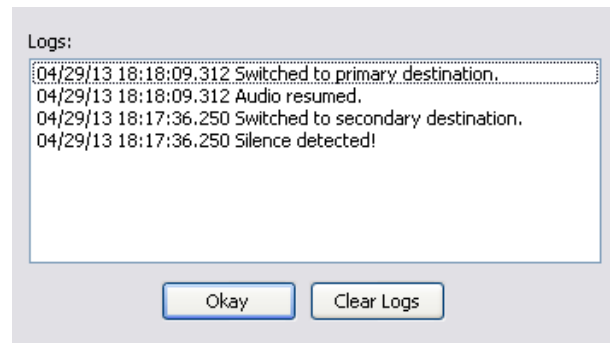

Security Settings

The IP-MTR64 Meters GUI can be password protected to keep unauthorized people from making changes. By default the password is empty.

Setting The Password

To set a password select *Network>Password...* from the menu.

Enter the *Old Password:* (or leave that field blank if there is no password currently set), then enter the new password in both the *New Password:* and *Verify New:* fields. Click *Okay*.



Operating With Security

When a password has been set and you start the program, you'll be prompted for a password:

Enter the password and click *Okay* to use the program. If the correct password is not entered the program cannot be started. There is also a level of security applied to certain functions of the program.

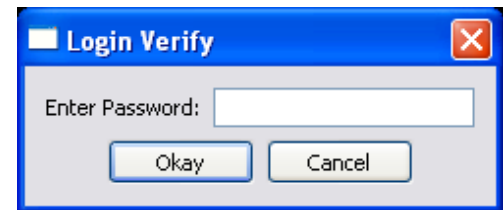

Making The Security Settings

Select *Setup>Preferences...* and switch to the *Security* tab.

Here you will see a number of tasks that can be *Un-Locked*, set to work *With Password*, or *Hidden*. Use these settings to prevent unauthorized operators from performing certain tasks.

You can also select or deselect check boxes for *Double Click to Zoom* and *Zoom Full Screen*.

Click *Okay* when done.

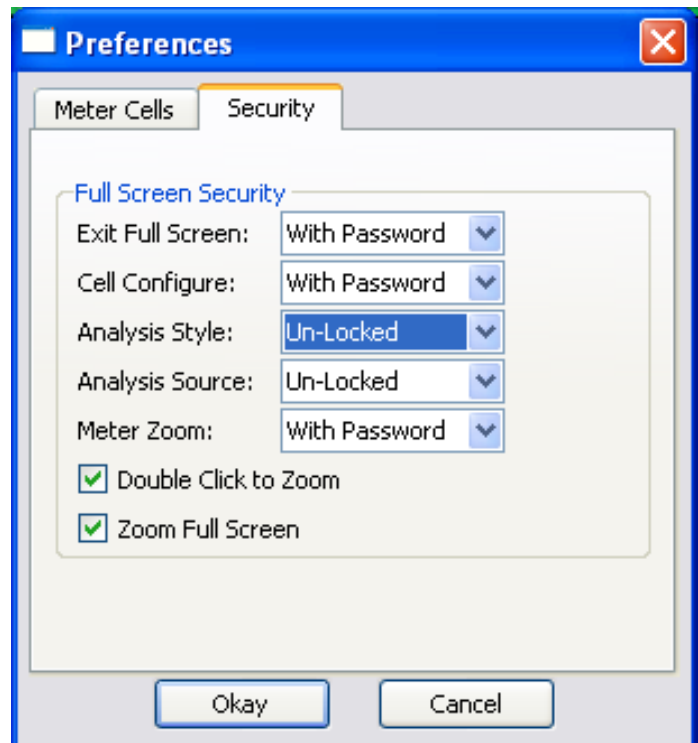

Menus

Operation of the IP-MTR64 Meters GUI is done through the use of menus, both drop down from the main menu bar, and popups that are activated by right-clicking at specified areas of the GUI. In this section we describe the various menu items, both those that have been described throughout the manual and those that haven't yet been mentioned.

View

The *View* menu contains a few items that are necessary for basic program configuration and operation. The available items are:

Full Screen – Switches the program to a full screen view that eliminates both the status bar and the title bar from the display and in fact also hides the Windows task bar. While in full screen mode you can right-click in the area of any meter cell and select *Exit Full Screen* from the popup to revert to a normal view. You can also use the F11 key to toggle in and out of full screen mode.

About... – Brings up a typical About dialog box to show you the program version.

Exit – Use to close the application.

Layout

The *Layout* menu contains items that are used to adjust the layout of meter cells and the analysis window. The available items are:

New – Use to create a new meter layout.

Open... – Use to open a previously saved layout file.

Save – Use to save the current meter layout to the last opened layout file.

Save As... – Use to save the current meter layout to a new file.

Configure... – Use to edit the current meter layout.

WheatNet-IP System

The *WheatNet-IP System* menu contains items used to acquire needed information from the WheatNet-IP system. The available items are:

Open... – Use to open a previously saved system information file containing a list of sources and destinations that the program used when system resources were discovered via a system scan. This is handy when you are going to be setting up a meter layout on a computer that is not currently connected to the system.

Save As – Use to save the current source and destination system information to a file for reference at a later time.

System Scan... – Begins the process of discovering the available source and destination signals in the WheatNet-IP system.

View Info... – Shows the list of source and destination signals known to the program.

Setup

The *Setup* menu contains items used to configure program options. The available items are:

Network... – Use to set the network interface and the Peripheral Devices port.

Preferences... – Use to set program color and labeling schemes, and to set the tasks protected by password.

Password... – Use to set a password that must be used to start the program and perform certain program functions.

Additional Popup Menus

Some popup menus are available by right-clicking within certain areas of the program window.

Right-click in a meter cell to bring up this popup:

Alarm Logs... – Use to view silence detect activity on a meter cell that is monitoring a destination configured for silence detection.

Zoom In... – Zooms that meter to a full-screen view for detailed observation.

Configure... – Brings up the dialog for configuring that cell.

Right-click in the analysis cell to bring up this popup:

FFT – Selects the FFT display type for the analysis window. This is a Fast Fourier Transform, or spectral analysis, of the selected audio signal.

O-Scope – Selects the O-Scope display type for the analysis window. This is a time domain display of the audio waveform's amplitude (vertical) vs. time (horizontal).

E vs F – Selects the E vs F display type for the analysis window. This displays the relative loudness using a 31-band 1/3 octave analysis.

3-D Plot – Selects the 3-D Plot display type for the analysis window. This is a three-dimensional plot of the audio. The left scale is audio level in dB, the bottom scale is audio frequency in Hz, and the diagonal lower-left-to-upper-right flow of the display represents time.

SDR – Selects the SDR display type for the analysis window. The Spectral Dynamic Range meter is a Wheatstone exclusive. Using a 31-band, 1/3 octave analysis the dynamic range of audio within each of the 31 bands is measured. The peak audio level is represented by the highest position of each meter bar, while the amount of dynamic range in each band is shown by the overall height of each bar. Very dense audio will be displayed with much shorter bars than very dynamic audio.

Configure... – Brings up the dialog to configure the current analysis window display. Each analyzer type has its own set of parameters that can be configured.

Take Source... – Brings up the dialog to select the source for the analysis display.

Summary

We have briefly discussed the IP-MTR64 Meters GUI program. We have described its function, how to install it, and how to use it. Like any software program, the best way to become acquainted with it is to use it, go through the menus, do some clicking here and there, and along the way decide how you can make the best use of its features for your particular application.

Appendix 7

Contents

WheatNet-IP Scheduler	A-78
Introduction To Wheatnet-IP Scheduler	A-78
Events And Signals	A-78
Installation	A-79
Requirements	A-79
Performing The Install	A-79
Uninstalling The Program	A-82
First Time Operation.....	A-82
License Key	A-82
First Time Operation When Connected To A System.....	A-83
When Connection To A BLADE3 Succeeds at Startup.....	A-85
When Connection To A BLADE3 Fails at Startup	A-86
Day To Day Operation	A-87
System	A-87
Set IP Address.....	A-87
Define Devices.....	A-88
Signals.....	A-89
Request Signals From Connected BLADE3	A-89
Load Signals From File.....	A-89
Save Signals To File	A-90
Events.....	A-90
Load Events From File.....	A-90
Save Events To File	A-90
Create Events	A-90
View Events	A-91
Edit Events	A-94
Schedule Events.....	A-95
Delete Events	A-95
Schedule Management	A-96
Moving Items.....	A-96
Deleting Items	A-97
Enabling and Disabling Items.....	A-97
Exiting With A Schedule Running.....	A-98
More On Existing.....	A-98

Logs.....	A-98
Viewing Logs	A-99
Menus.....	A-99
File.....	A-99
Edit	A-100
Events.....	A-100
Schedule	A-100
Signals.....	A-101
Help	A-101
Event Log Menu	A-101
Event Log Menu - File	A-101
Event Log Menu - Edit.....	A-101

WheatNet-IP Scheduler

Introduction To WheatNet-IP Scheduler

The WheatNet-IP Scheduler program is designed to fire Events in a WheatNet-IP system at pre-arranged times.

In order to integrate the software into a WheatNet-IP system, you will need to run it on a computer having a unique IP address on the same subnet as the WheatNet-IP system (typically 192.168.87.xxx). You will also need to know the IP address of at least one BLADE3 in the system, since the software will need to directly address a BLADE3.

What are events? Simply put, they are actions that will occur within a WheatNet-IP system. The software supports Connect, Disconnect, Salvo, and ACI (Automation Control Interface) events. Events are configured within the software, and are also **fired** by the software. Events act on system **signals** (Connect and Disconnect events) and **salvos** (Salvo events). ACI events direct automation-specific **commands** to various devices in the WheatNet-IP system. Events may be saved to a file, and the saved event files may be loaded into the program. This allows you to create a schedule on one computer, then load and run the schedule on a different computer.

Since a scheduler by its very nature performs tasks at specific times, it is important to note that the WheatNet-IP Scheduler depends on the clock on the PC that the program is running on to know precisely when to fire an event. Thus the PC clock needs to be set to the correct time and date to match its location. Otherwise, events will not fire as expected.

Events And Signals

As stated above, the software utilizes various event types, signals, salvo definitions, and commands to compose the events necessary to effect the desired actions within the system at the appropriate times. These items will be discussed briefly here.

As previously stated, an event is an occurrence within the system that can be caused to take place at a specified time according to a schedule. Four types of events are supported in the software.

A **Connect** event is one that causes a particular source (input) in the system to feed a particular destination (output) in the system at the scheduled time. Both sources and destinations can be specified by signal Name and Location (which are assigned by the system administrator via the WheatNet-IP Navigator program) or signal ID (which is automatically assigned within the WheatNet-IP system based on the rules the system imposes to define signals).

It should be noted here that only one source can be connected to a given destination at a time. For this reason, an event that causes a source to be connected to a destination which already has a different source connected will cause the original source to be disconnected prior to making the new connection.

Also worthy of note is that connections in the system may be locked, and that the Scheduler software will not override signal locks.

The next type of event is a **Disconnect** event. In this case no source need be specified, only a destination. If a source is currently connected to the specified destination, the disconnect event will break that connection.

The third type of event is the **Salvo** event. Salvos are configured within the WheatNet-IP Navigator program, and consist of sets of connections and/or disconnections that will happen rapidly in sequence when the salvo is fired. Salvos are identified both by Name and ID when constructing a salvo event.

The fourth type of event is the **ACI** event. This type of event is used to send ACI commands to various pieces of equipment within the WheatNet-IP system. The program currently supports sending ACI commands to BLADE3s, Surfaces, and Processors. It is beyond the scope of this manual to list all of the ACI commands available for your use. Examples will be shown, but otherwise please contact Wheatstone Technical Support at 252-638-7000, or email us at techsupport@wheatstone.com, to discuss your specific requirements.

Installation

The software is distributed as a Windows Installer file with extension `.msi`. You will only need to double-click this file's icon to begin the installation procedure.

Requirements

The WheatNet-IP Scheduler software does not have a heavy requirements list. It will install on any modern computer with a Windows 2000 through Windows XP operating system.

Performing The Install

Double-click the installer file's icon to begin the installation and see the following screen:

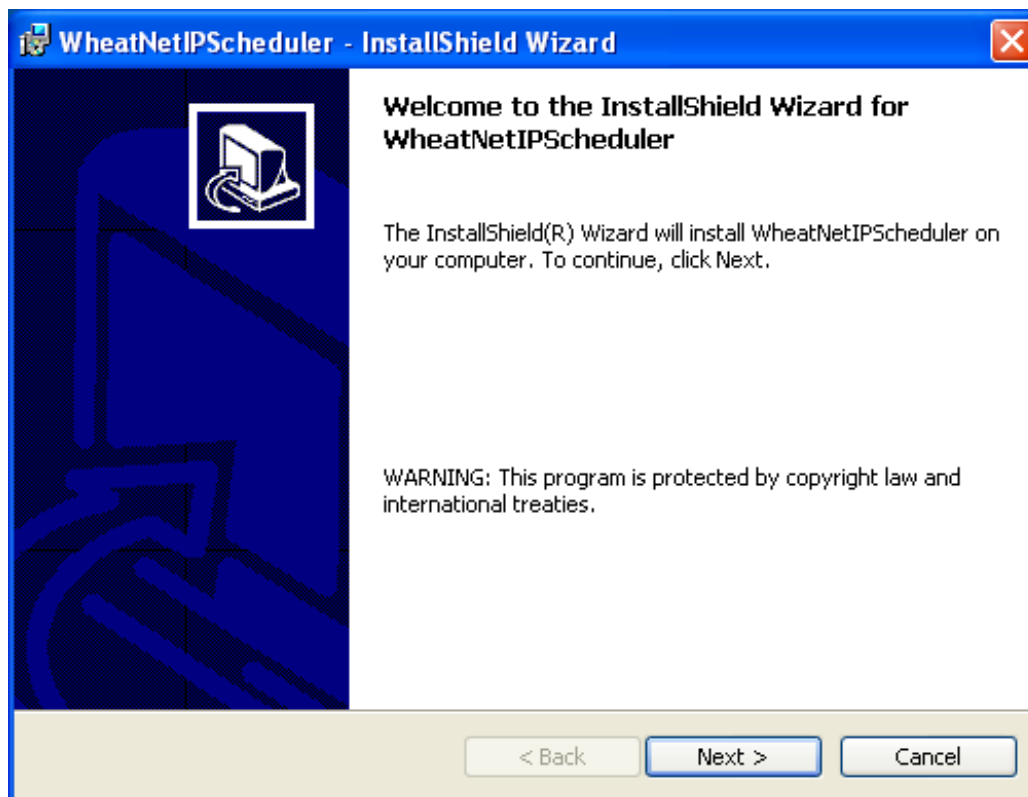

Click *Next >*.



Accept the license terms and click *Next >*.

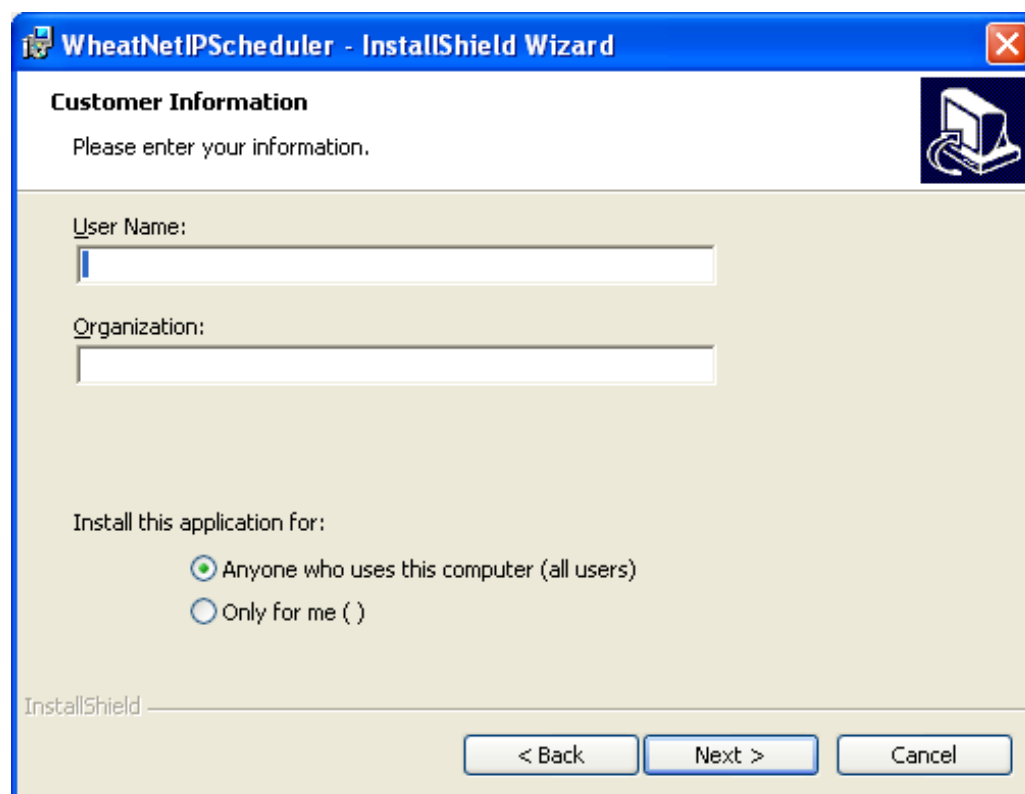

Enter name and organization, select for individual or all users, and click *Next >*.

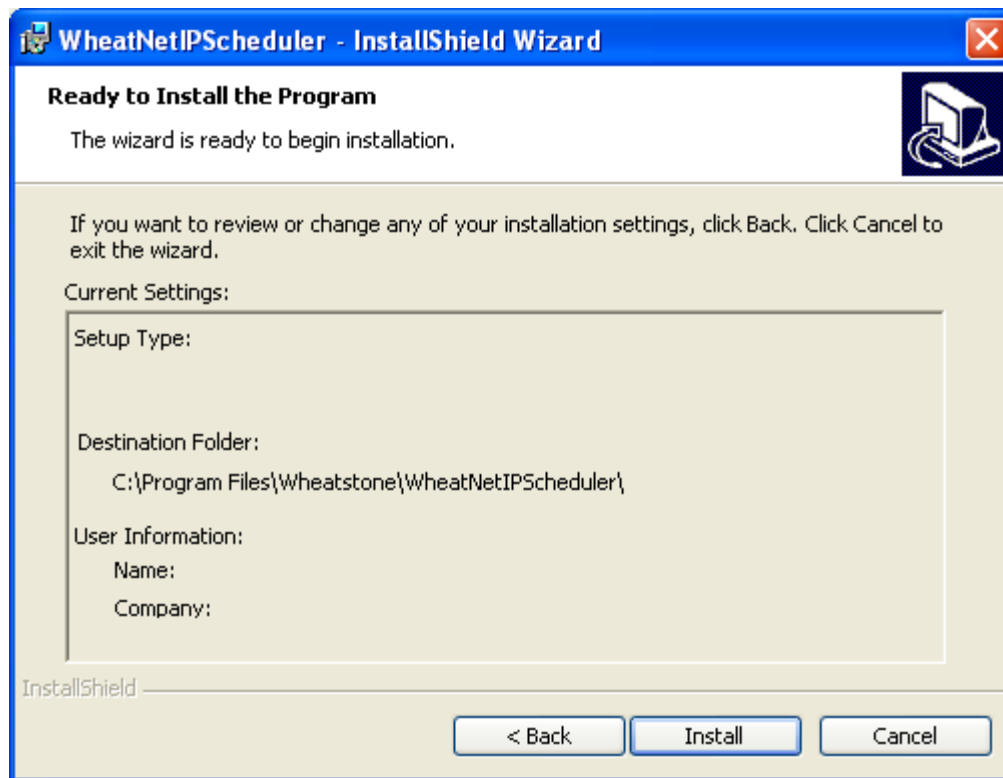

Click *Install*. After a couple of progress screens go by, you will see the screen that indicates the installation is complete.

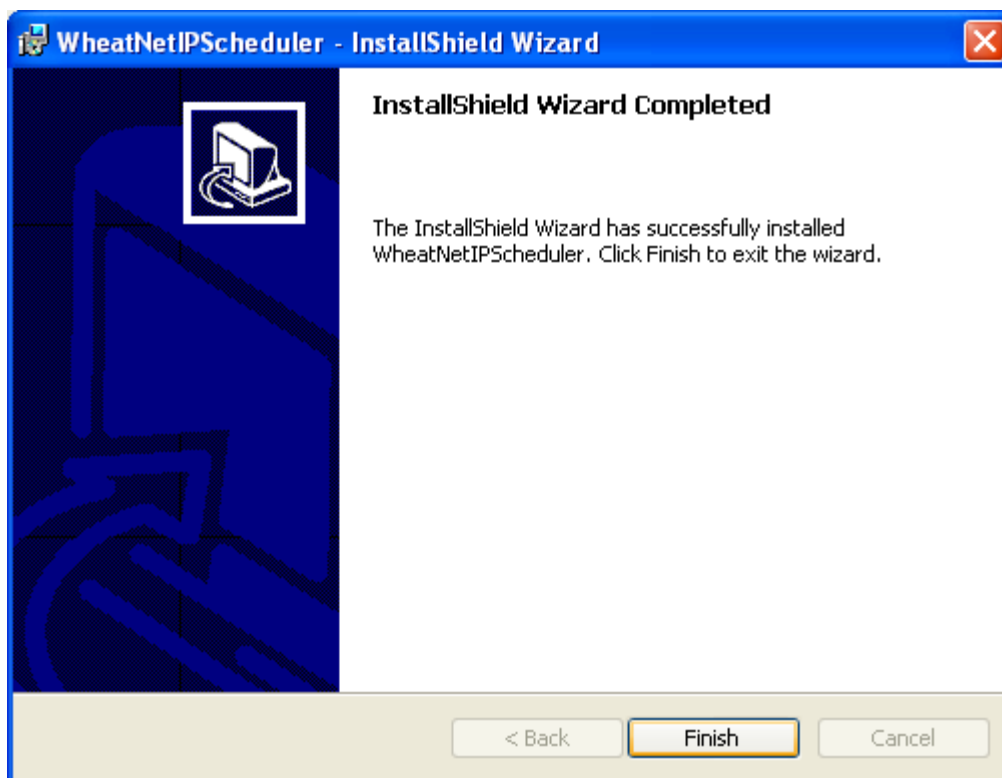

Click *Finish* to complete the installation.

An icon will appear on your desktop that you can use to start the Scheduler program.

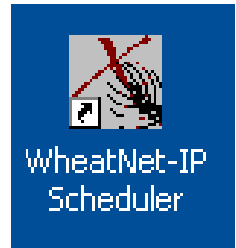

Uninstalling The Program

Should it become necessary or desirable to uninstall the WheatNet-IP Scheduler, use the Windows Add or Remove Programs Control Panel.

First Time Operation

First time operation of any software is a learning experience. With the WheatNet-IP Scheduler program, the steps involved in first time operation will differ depending on whether or not you are actually connected on the same network as a WheatNet-IP system.

License Key

The first time you start up the program you will be asked for a License Key.



If you wish to run the software beyond the seven day Trial Period you will need to purchase a site license for the program from your Wheatstone Corporation sales representative.

To continue without entering a License Key click *Later*. Each time you restart the program without having entered a valid License Key you will again be prompted to enter one. After the seven day Trial Period is over the nag screen will no longer give you the option of continuing unless you enter a valid License Key.

If you have a License Key to enter, click *Enter License Key...* to bring up the following screen:

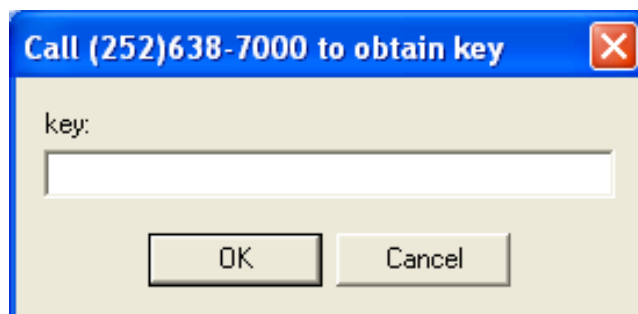

Enter the License Key that you obtain from Wheatstone Technical Support and click *OK*. The following screen appears when a valid License Key has been entered:

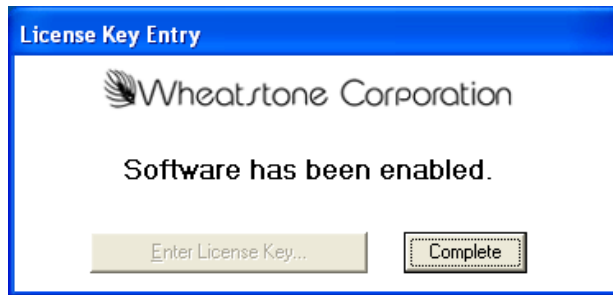

Click *Complete* to proceed.

First Time Operation When Connected To A System

The first time you start up the program some assumptions will be made regarding default settings. It is most important to understand the underlying assumptions when first time operation takes place with the computer connected to a WheatNet-IP system, so that you are not surprised as initial operating conditions are first assumed and then discovered. The opening screen will look like this:

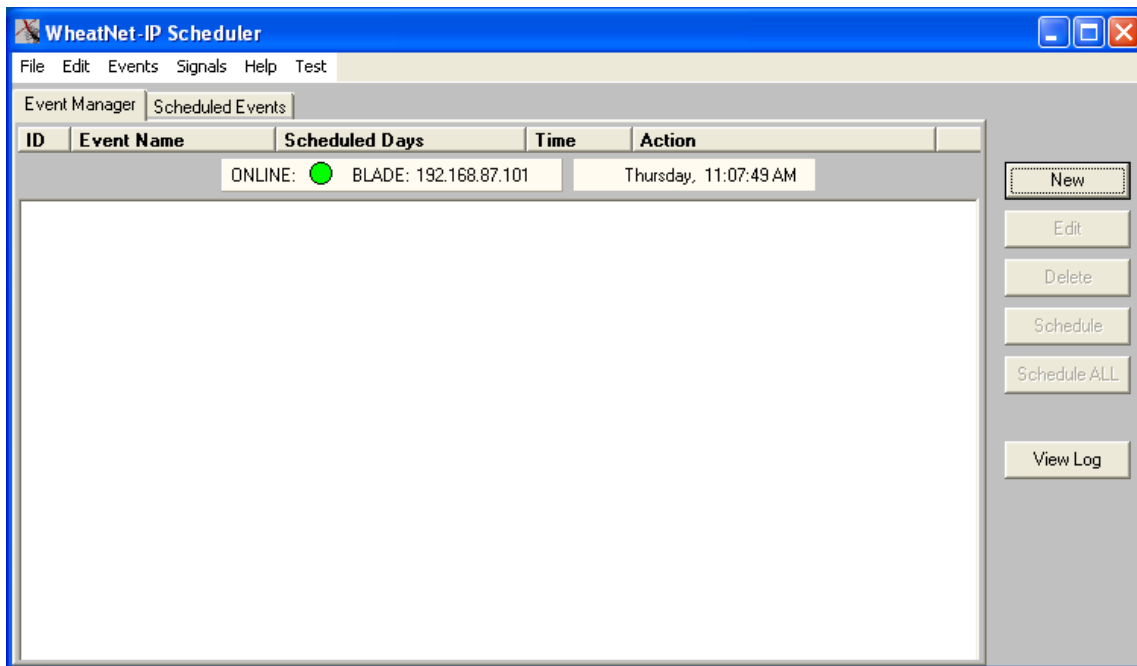

When the program starts up it attempts to make a connection with a WheatNet-IP BLADE3 at a particular address. The first time that you start the program after installation it will look on the network for a BLADE3 at IP address 192.168.87.101 (the default address for a BLADE3 with ID of 1). If your system is on the default subnet of 192.168.87.xxx, and you have a BLADE3 with BLADE3 ID of 1 in the system, and your computer is at a unique address on the same subnet, then the program will most likely succeed in connecting to the BLADE3. If any one of these conditions is not met then the program will almost surely fail to connect to a BLADE3. Regardless of which case applies, the program will attempt to fetch signals from the system by querying the BLADE3 IP address it defaults to.

The fetch process shows the following sequence of screens if it succeeds in connecting to a BLADE 3:

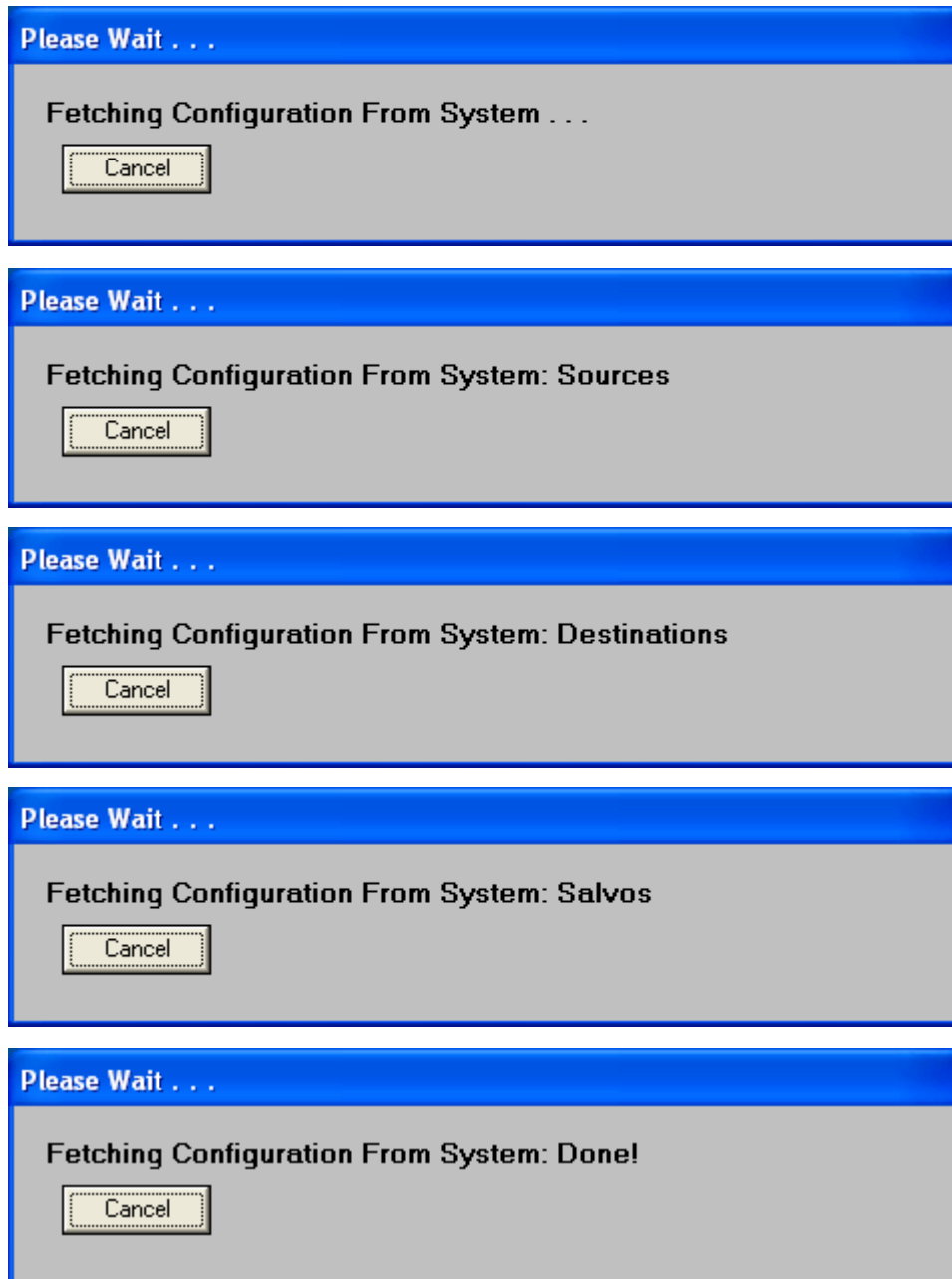

You may stop the fetch process at any time by clicking *Cancel*.

When Connection To A BLADE3 Succeeds At Startup

Once the signals have been fetched from the connected BLADE3 you will see a screen with some brief instructions on what to do next:

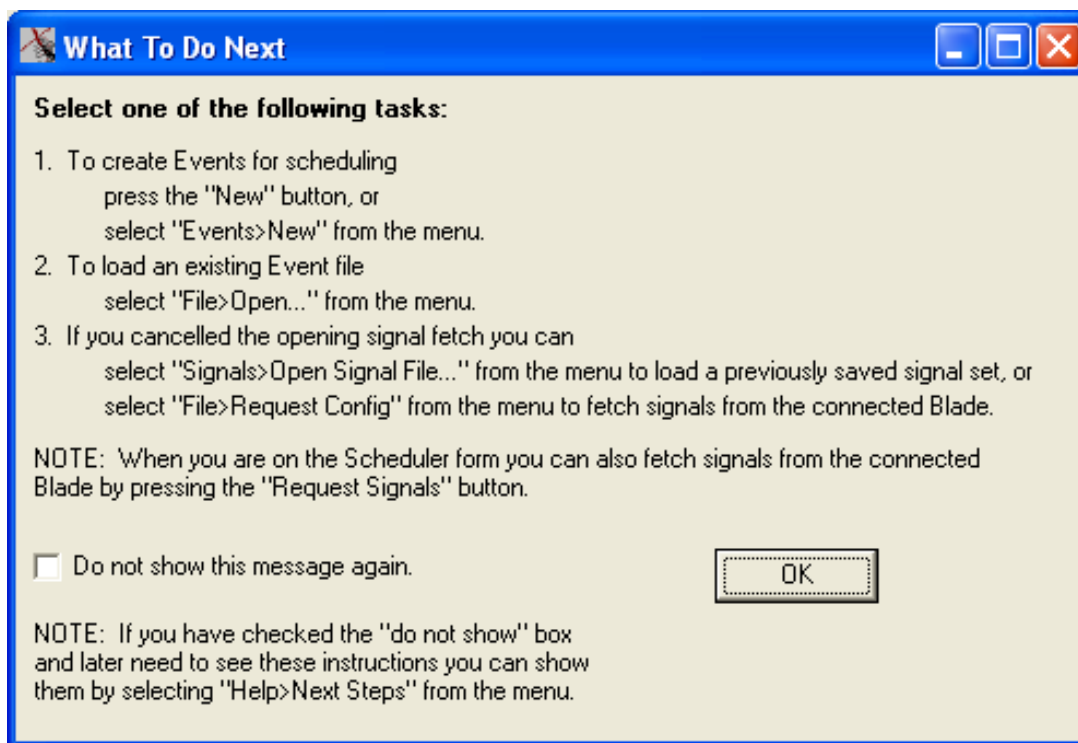

As indicated on this screen, there are several possible things you might want to do next. If you have not yet saved an event file, you might want to begin by creating some events, while, if you have already saved an event file, you may want to load it, either to edit the event set, or to start the schedule running. If you canceled the signal fetch before it was complete, you may have a signal set you saved previously, and you can load that signal set. Or maybe you just want to poke around and become familiar with the software.

Since we are discussing first time operation under conditions where signal fetching succeeds, you would most likely want to begin setting up a few events.

Once you have gleaned all the useful information the screen has to offer, click *OK*.

You will notice that this screen will show up every time you start the program, once signals have been fetched or loaded. You will eventually get pretty tired of seeing it. So what can you do? Before clicking *OK*, click the *Do not show this message again*. checkbox. Should you ever decide you want to see this screen again, you can show it by selecting *Help>Next Steps* from the menu.

When Connection To A BLADE3 Fails At Startup

If the fetch process described above does not succeed, the sequence of fetch progress screens will be terminated and the following screen will appear:

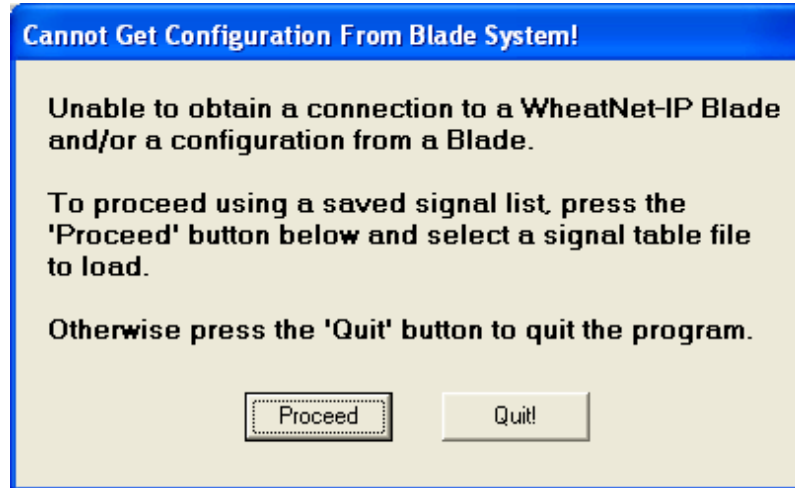

Since we are discussing first time operation under conditions that cause the signal fetch to fail, we recommend clicking the *Proceed* button, since if you click *Quit* the program will terminate and your learning session will end.

Clicking *Proceed* will result in a standard Windows file open dialog box being presented, and the first time you encounter this screen it will be pointing to the default settings folder for the program, which is <user>/Application Data/Wheatstone/WheatNetIP-Scheduler. You would normally save your signal set files and event files here. Within this folder is a folder named *samples*, which has a sample signal file and a sample event file. This would be a good place to begin if you are just starting to work with the program and are not connected to a WheatNet-IP system. So go ahead and open the *samples* folder and double click the *sample.sigtab* file you find there.

At this point you are viewing the main screen:

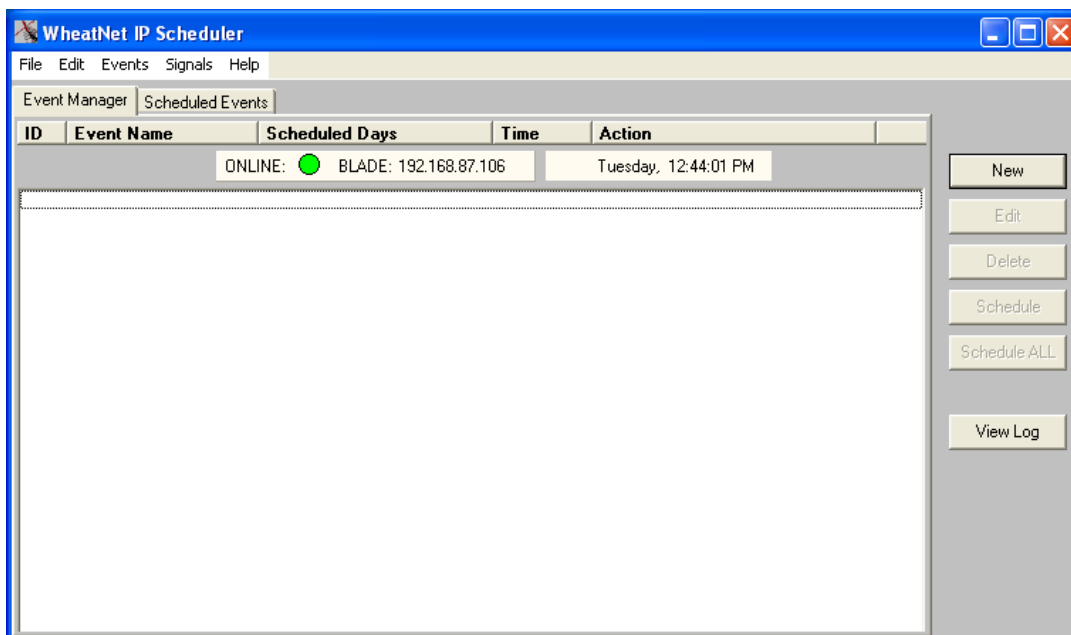

The main difference you will see between the above picture and what you see on your screen (other than that your window may be maximized) is that the ONLINE indicator will probably be gray, and the BLADE 3 IP address will be 192.168.87.101, the address the program defaults to.

If you have followed our suggestion to load the sample signal set, select *File>Open...* and load the sample event set (`sample.evt`) as well.

The section that follows describes the various tasks you can do within the program and how to perform them.

Day To Day Operation

As you become more familiar with the program operation you will begin discovering the tasks you want to perform with the software. This section of the manual details the various tasks, what they are for, and how to perform them. For the sake of discussion, tasks are organized by category: System, Signals, Events, Schedule Management, and Logs.

System

In order to perform any useful function, the program ultimately needs to interface with a WheatNet-IP BLADE 3. Unless you will only be interfacing with a BLADE 3 at the default BLADE 1 IP address of 192.168.87.101, you will need to know how to specify the BLADE 3 that the program communicates with.

Please note that in a system with multiple BLADE 3s, it generally doesn't matter which BLADE 3 you connect to when running a schedule.

Set IP Address

There are two different ways to change the BLADE 3 that the program will connect to.

From the menu, select *File>Set IP Address...* to bring up the form on the right:

For convenience you can type a name in the *Name* field. The name is not actually used.

Enter the IP address of the BLADE 3 you want the software to communicate with. Once the IP address is entered, click *Apply*. You will be prompted to restart the WheatNet-IP Scheduler Program before your new IP address will take effect.

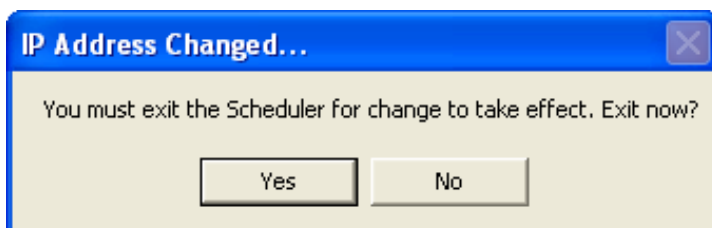
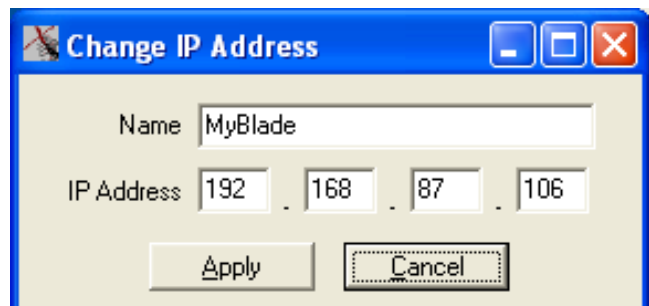

You can click *Yes* to exit immediately, or click *No* if you are not ready to exit. Until you do exit and restart it, the program will still be attempting to communicate with the previously specified BLADE 3.

The other way to change the IP address is to click on the word *BLADE* next to the *ONLINE* indicator.

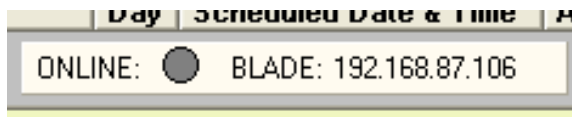

This will bring up the change dialog, and the rest of the procedure is the same as when started from the menu.

Define Devices

If you plan on using any ACI command events you will need to define the device or devices you want to control. From the menu, select *File>Define Devices* to bring up the following form:

Current Settings		New Settings - Will Take Effect On Program Restart	
Device Type	IP Address	Select New Device Type	Set New IP Address
blade	192.168.87.103	<input checked="" type="radio"/> Blade <input type="radio"/> Surface <input type="radio"/> Processor	192 • 168 • 87 • 103 Delete # 1
surface	192.168.87.100	<input type="radio"/> Blade <input checked="" type="radio"/> Surface <input type="radio"/> Processor	192 • 168 • 87 • 100 Delete # 2
blade	192.168.87.102	<input checked="" type="radio"/> Blade <input type="radio"/> Surface <input type="radio"/> Processor	192 • 168 • 87 • 102 Delete # 3
blade	. . .	<input checked="" type="radio"/> Blade <input type="radio"/> Surface <input type="radio"/> Processor	. • . • . Delete # 4
blade	. . .	<input checked="" type="radio"/> Blade <input type="radio"/> Surface <input type="radio"/> Processor	. • . • . Delete # 5
blade	. . .	<input checked="" type="radio"/> Blade <input type="radio"/> Surface <input type="radio"/> Processor	. • . • . Delete # 6
blade	. . .	<input checked="" type="radio"/> Blade <input type="radio"/> Surface <input type="radio"/> Processor	. • . • . Delete # 7
blade	. . .	<input checked="" type="radio"/> Blade <input type="radio"/> Surface <input type="radio"/> Processor	. • . • . Delete # 8

Delete # X button sets device X type to Blade and IP address to blank.

Apply Commits Type changes and valid IP address changes without closing form.

Cancel Cancels any uncommitted changes without closing form.

Close Commits Type changes and valid IP address changes, then closes form.

This is quite a busy form, so let's take it on in sections.

The *Current Settings* area indicates any ACI devices that have already been set up. Until you have set up one or more devices this area will indicate that all eight devices are of type *blade*, and all of the IP Address entries will show . . . to indicate that they have not been defined.

The *New Settings* area on the right also shows any settings that have already been made, and allows you to easily add devices or edit existing devices.

The normal procedure for adding a device is to first use the Radio Buttons to specify if the device type is *BLADE* (default), *Surface*, or *Processor*. Next, enter the IP Address of the device in the spaces provided. ***It is important to correctly match the device type and the IP Address since different device types use different ports for their ACI communications.***

Editing is just as simple; change the device type, if needed, and enter the new IP Address.

If you want to undefine a device, simply click the *Delete # X* button that corresponds to the device you no longer need.

You can commit your changes at any time by clicking *Apply*; the form will remain open. If you have made some changes but want to cancel your changes, you can click *Cancel* to revert any uncommitted changes back to what they were. *Cancel* will **not** affect changes that have been committed.

When you are done defining devices click the *Close* button to commit your changes and close the form. You will be prompted to restart the program before the new device data will actually be used. Click *Yes* or *No* as desired.

Signals

Signals are an integral part of Connect and Disconnect events. Although you can schedule one of these events without specifying signals, the event will do nothing when fired.

Signals are operated upon within the WheatNet-IP system according to their Signal ID, and you can, in fact, specify signals by referring to the ID. However, the signal IDs are somewhat cryptic, and signals can be given names that we humans will find much more meaningful.

Further, it makes sense from a human standpoint to have items with similar functions named with similar names. For an example relative to the project at hand, we may find it convenient to have a signal named “Fred” feeding an input on a BLADE3 located in Studio 1, and a signal of the same name feeding a BLADE3 in Studio 2, because Fred sometimes works from one studio and sometimes from the other. And so we allow the name to be extended by appending a Location to the name. In this example we would have Fred – Studio 1 and Fred – Studio 2. In this way we can easily distinguish the two signals even when they share a common name.

Signal names and locations are generally configured with the WheatNet-IP Navigator GUI. We just use the same names here, getting them from the fetched signal set.

If your signal names (and locations) have come from a connected BLADE3, the signals that that BLADE3 is aware of will be the same signals that you will have access to when creating and editing events. As an alternative you can load a set of signals that was previously saved to file, and the signals in that file will be the ones you have access to when working with events. If you are not connected to a BLADE3 and choose to cancel the loading of signals from a file you will not have any signals to work with. Sure, you can still create and edit events, but the results will be pretty meaningless.

Request Signals From Connected BLADE3

To request signals from the connected BLADE3 while at the main screen, select *File>Request Config* from the menu. Or, if you are on the *Event Properties* screen (see below “Create Events” section) you can click the *Request Config* button. Either method will start the signal fetch process already described.

Load Signals From File

If you have previously save a signal set, or if you want to view the sample signal set that is provided for you during product installation, select *Signals>Open Signal File...* from the main menu. This will open a Windows file open dialog, which will point to the default location for event and signal files the first time the program is run, or the location loaded from or saved to the last time the program was run. Navigate to the desired location, select the file, and click *OK*.

Save Signals To File

If you have successfully fetched signals from a system and want to have a copy of the signal set available so you can create and edit events without needing to be connected to a BLADE3, you will want to save your set of found signals. Select *Signals>Save Signal File...* from the menu to open a standard Windows file save dialog. Navigate to the desired folder if necessary, choose a memorable name for the file, and click *OK*.

Events

The unit building block used by the schedule as it operates is termed an Event. As previously discussed, there are four types of events: the Connect Event, the Disconnect Event, the Salvo Event, and the ACI Event. Events are created and edited from the *Event Properties* form, as discussed below. Sets of events can also be saved in a file for future scheduling.

Load Events From File

If you have previously saved an event set, you can load that set by selecting *File>Open...* from the main screen. A standard Windows file open dialog allows you to select a file to open. Once the file has been loaded you can begin working with it.

Save Events To File

You may find it desirable to save a set of events you have created. Select *File>Save...* from the main menu. This opens a standard Windows file save dialog.

Create Events

If you are starting from scratch to create events, select *Events>New* from the main menu. This opens the *Event Properties* screen, which looks like this:

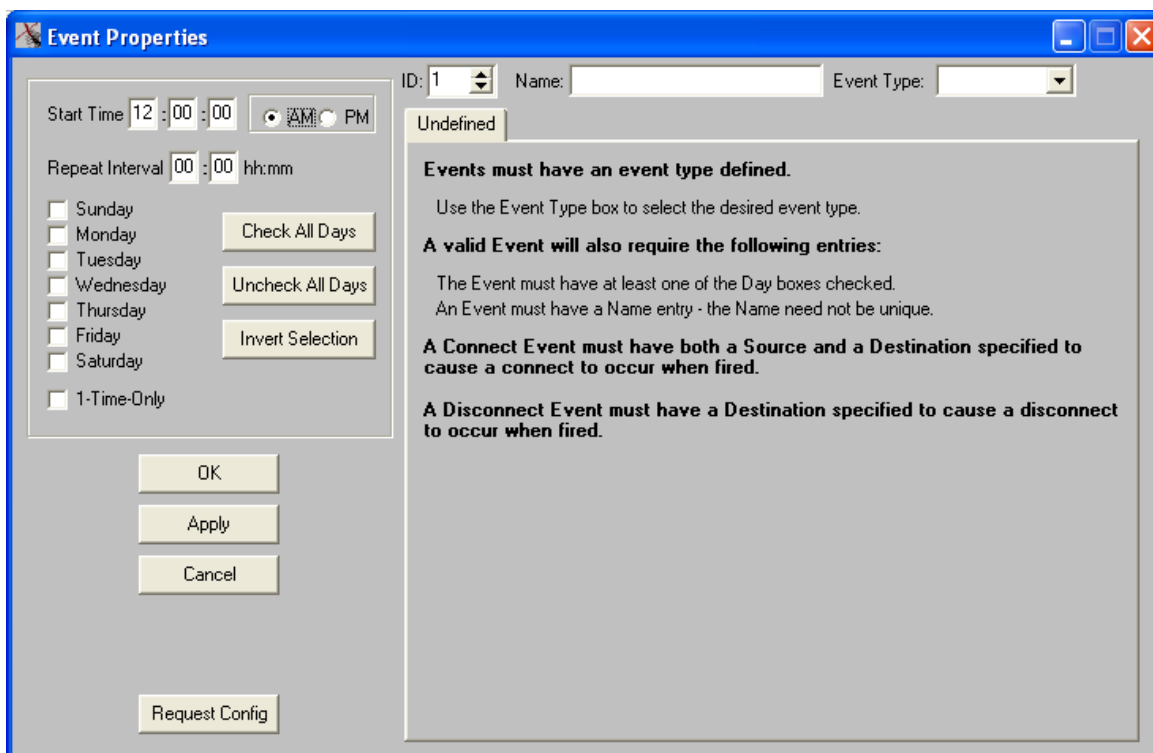

Event Properties

ID: 1 Name: Event Type: Undefined

Start Time 12 : 00 : 00 AM PM

Repeat Interval 00 : 00 hh:mm

Sunday Monday Tuesday Wednesday Thursday Friday Saturday 1-Time-Only

Check All Days Uncheck All Days Invert Selection

OK Apply Cancel Request Config

Events must have an event type defined.
Use the Event Type box to select the desired event type.

A valid Event will also require the following entries:
The Event must have at least one of the Day boxes checked.
An Event must have a Name entry - the Name need not be unique.

A Connect Event must have both a Source and a Destination specified to cause a connect to occur when fired.

A Disconnect Event must have a Destination specified to cause a disconnect to occur when fired.

Let's take a closer look at the various parts of this form, starting with the right side of the form. At the top we see an ID box that we can use to scroll through the events. This is followed by a *Name* field, where the event is given a name. To the right of that is an *Event Type* drop down box, where the type of event will be selected. Note that, in the picture, the *Event Type* is blank, and the tabbed area below displays a tab titled *Undefined*. The tabbed area title and contents will change depending on the type of event selected. When the *Event Properties* form is first viewed by clicking the *New* button on the main screen, or selecting *Events>New* from the menu, this is how the form will look. We will take a closer look at the various event type tabs later.

Worthy of note is the text displayed on the *Undefined* tab. This defines what is required before an event being created is accepted by the software. If you try to proceed from the currently viewed event to another by clicking *Apply* or *OK*, you will not be able to proceed unless certain information is furnished. The event must have an *Event Type* specified, must have at least one *Day* box checked, and must have a *Name* assigned.

Note that you can get away with not assigning signals to a Connect or Disconnect Event; however, such events will do nothing when fired.

The left side of the dialog, at the top, gives you the tools for specifying when an event will fire. The *Start Time* specifies the first time on a checked *Day* that the event will fire. Enter the time in 12 hour mode, and specify *AM* or *PM*.

The *Repeat Interval* determines how often an event will fire on a checked *Day*. The *Repeat Interval* is specified in hours and minutes. As an example, if the *Repeat Interval* is specified to be 4 hours and 30 minutes, and the *Start Time* is 2:15:00 PM, the event can be expected to fire on a checked day at 2:15, 6:45, and 11:15 (all these are PM times).

There are separate check boxes for each day of the week, *Sunday* through *Saturday*. Events will not be fired on days that are not checked. For convenience, the *Check All Days* and *Uncheck All Days* buttons are provided, with rather obvious consequences. The *Invert Selection* button checks all unchecked *Day* boxes and unchecks all checked *Day* boxes.

The *1-Time-Only* check box is a little less obvious. When this box is checked, once an event fires it is deleted from the list. However, if the box is not checked, the fired event is added at the bottom of the schedule, one week later in time than when it just fired.

Below the schedule settings are two buttons used to enter the event in the *Event Manager* list. *OK* enters the current event in the list and closes the *Event Properties* dialog, while *Apply* adds the current event to the list but leaves the *Event Properties* dialog in place. A third button, *Cancel*, er – ah – cancels the event, and it is not added to the list.

Advancing the previously described *ID* spin box without first clicking *Apply* on the current event results in a prompt that asks you to decide if you want to apply changes before viewing the next event.

The previously discussed *Request Config* button on the left side of the dialog at the bottom is used to fetch signals from a connected BLADE 3.

View Events

The *Event Properties* dialog shows you the properties of the event currently being viewed. As mentioned above, the tabbed area will change depending on the *Event Type*. Let's look at this a little more closely.

If *Connect* is selected as the *Event Type*, the tabbed area looks like this:

The screenshot shows a software interface with a tab labeled "Connect". Below the tab, the text "Set Up Connect Type Events Here" is displayed. There are two main sections: "Destination (Output Signal)" and "Source (Input Signal)". Each section contains a "Name and Location" dropdown menu and a "Signal ID" dropdown menu.

Notice that a Connect Event is used to connect a given source signal to a given destination signal. The signals are specified on this tab. You can select a signal by its *Signal ID* if you know it, but you do not need to know the *Signal ID* to specify it. The signal can also be selected by *Name and Location*. If you are not sure of the *Name and Location* associated with the signal you want to use, and do not know the *Signal ID* either, you can still have the event added to the *Event Manager* list. However, the event will do nothing when fired unless valid signals are specified.

Note that when you scroll to an already defined Connect Event the programmed signals will be shown.

If *Disconnect* is selected as the *Event Type* the tabbed area looks like this instead:

The screenshot shows a software interface with a tab labeled "Disconnect". Below the tab, the text "Set Up Disconnect Type Events Here" is displayed. There is one main section: "Destination (Output Signal)". This section contains a "Name and Location" dropdown menu and a "Signal ID" dropdown menu.

A Disconnect Event is used to disconnect the current source signal (which does not need to be specified) from a given destination signal. The destination is specified on this tab. Once again you can select a signal either by its *Signal ID* or by its *Name and Location*.

Note that when you scroll to an already defined Disconnect Event the programmed signal will be shown.

If *Salvo* is selected as the *Event Type* the tabbed area changes once again:

The screenshot shows a tabbed window with the 'Salvo' tab selected. The title bar of the tabbed area reads 'Set Up Salvo Type Events Here'. Below this, there is a sub-section labeled 'Salvo' containing two input fields: 'NAME: Salvo1' with a dropdown arrow, and 'Salvo Number: 1' with a spinner control.

A Salvo Event is used to select a particular salvo to fire (please read the section of the WheatNet-IP manual that deals with the Navigator software to find out more about salvos). You can select the desired salvo either by its *Signal Number* or by its *Name*.

Note that when you scroll to an already defined Salvo Event the programmed salvo information will be shown.

Selecting ACI as the Event Type results in this in the tabbed area:

The screenshot shows a tabbed window with the 'ACI' tab selected. The title bar of the tabbed area reads 'Set Up ACI Type Events Here'. Below this, there is a sub-section labeled 'ACI Command String'. It contains a table with columns: Device, Type, IP Address, and OnLine. The values are: Device: 2, Type: surface, IP Address: 192.168.87.100, and OnLine: a green circle. Below the table is an empty text box labeled 'Event ACI Command String:'. Underneath that is a 'Compose String:' section with a dropdown menu containing '<INPUT:1|ON:1>'. At the bottom, there are three buttons: 'Save String', 'Enter', and 'Test', each with a corresponding explanatory text block.

Save String "Save String" adds the Compose String box text to the drop-down list for reuse.

Enter "Enter" copies from the Compose String box to the Event ACI Command String box to add the string to the event being defined.

Test "Test" sends the Compose String entry to the specified device. The device must be online for the action to occur.

Use the *Device* spin dial to select the desired device for this **ACI** event. As you cycle through the defined devices the device *Type* and *IP Address* fields will reflect the properties of the device. In this instance we have selected device 2, which is a control surface located at 192.168.87.100. The *OnLine* indicator will be green if the program is able to connect to the selected device, or red if not.

Once the device is selected you must compose a command string appropriate to the device. In our example we want fader 1 on the surface to turn on when the command is issued. The basic format for a fader on/off command to a surface is this: <INPUT : x | ON : y> where x indicates the fader number and y indicates the desired fader state, with 1 indicating on and 0 indicating off. This command is entered in the *Compose String* field. Note that letters are automatically converted to upper case when entered, so there is no need to use Shift or Caps Lock.

Once you have composed the desired command string you may want to test it. Press the *Test* button and the string in the *Compose String* field will be sent to the selected device.

When you are sure the command string is doing what you want, press *Enter*. This copies the command string from the *Compose String* field to the *Event ACI Command String* field.

If you have composed a command string you think you may need again press the *Save String* button. The program can remember up to 50 command strings this way.

Note that when you scroll to an already defined ACI Event the programmed device information will be shown, and command string will appear in the *Event ACI Command String* field.

As previously mentioned, it is beyond the scope of this manual to list all of the ACI commands available for your use. Please contact Wheatstone Technical Support at 252-638-7000, or email us at techsupport@wheatstone.com, to discuss your specific requirements.

Edit Events

If you have an existing event that you want to modify, you once again need to be on the *Event Properties* dialog. If you are already on this form you can use the *ID* spin dial to scroll to the event you want to change. Or if you are at the main window and viewing the *Event Manager* tab you can highlight the event and click *Edit* or select *Events>Edit* from the menu. The process of editing an event is to change the *Event Properties* from the current settings to the desired settings. The pertinent information has already been discussed.

Schedule Events

With a few events in the Event Manager list, your main screen, *Event Manager* tab, could look like this:

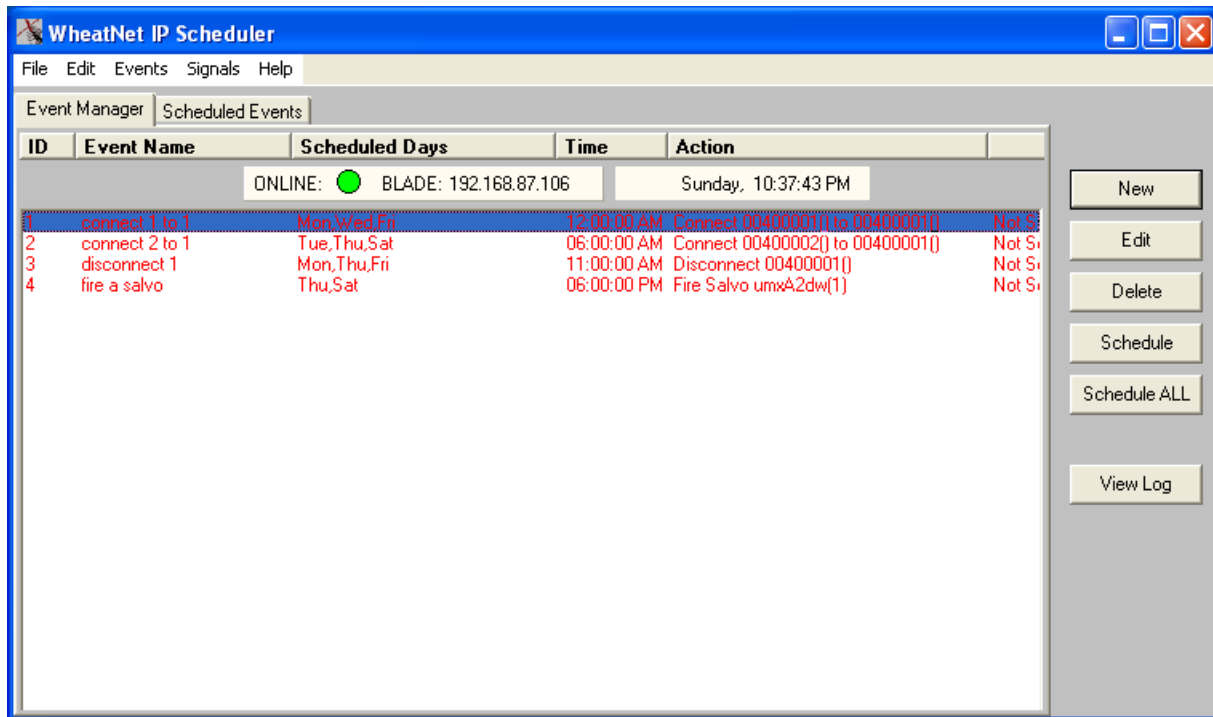

With a single event highlighted, as shown, you can click *Schedule*, or select *Events>Schedule*, to schedule only that event. You could also highlight, using either the Shift key or the Ctrl key, a small number of events, say two or three, and use *Schedule* to schedule only those events. Or you can use the *Schedule All* button or select *Events>Schedule All* to add all events in the list to the schedule; in this case you only need to highlight one event.

Delete Events

From the *Event Manager* list, you can highlight an event and click the *Delete* button or select *Events>Delete* from the menu to delete that event. This will delete the event from the *Event Manager* list and also delete any as yet unfired instances of the event from the schedule:

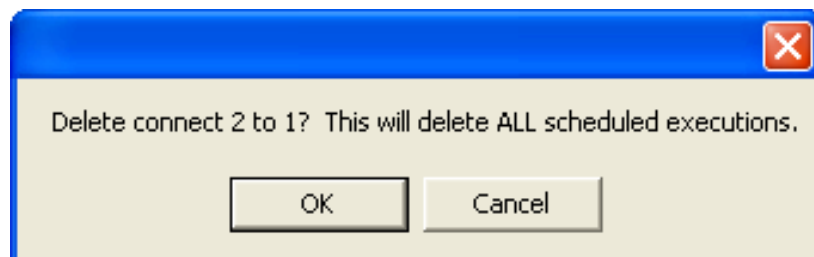

Click *OK* to proceed, or *Cancel* if you've changed your mind.

Schedule Management

Once you have created some events and added them to the schedule, you can view the schedule list from the main form by selecting the *Scheduled Events* tab:

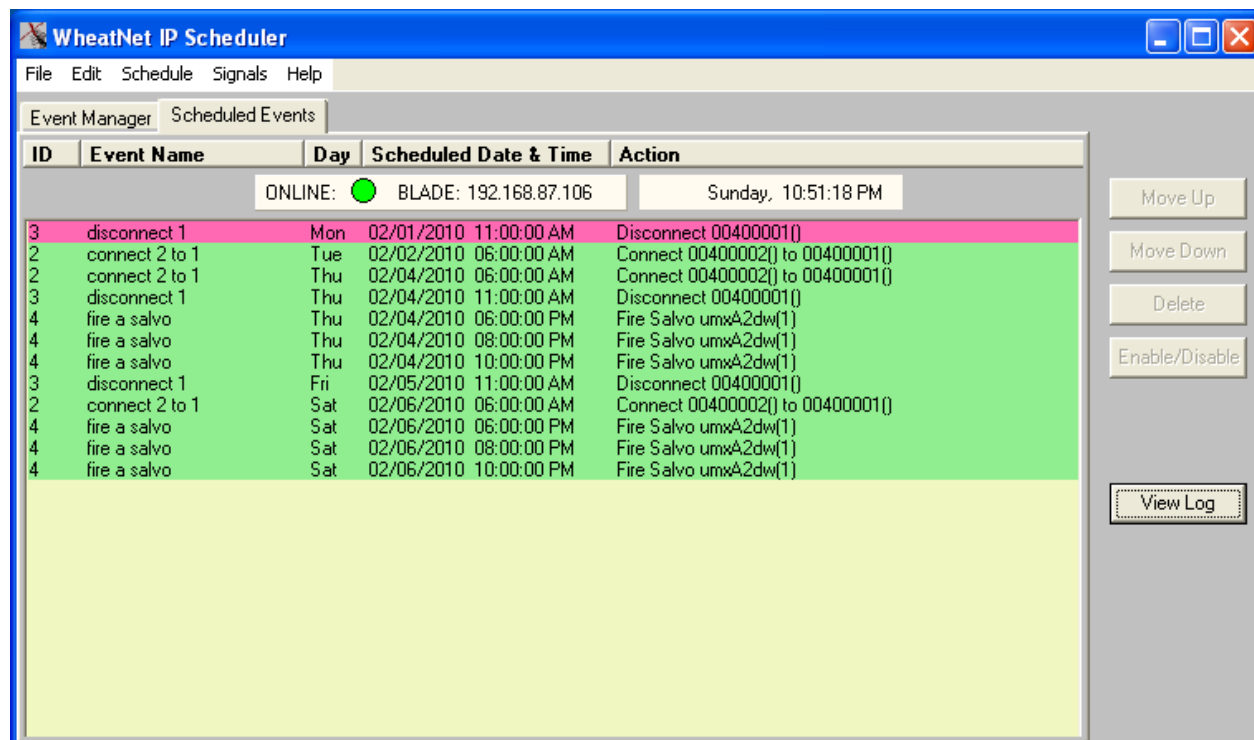

As the event at the top of the list fires, it is removed from the list. If the event is not specified to fire one time only, the same event will then appear at the bottom of the schedule list, for a time one week in the future from the time the event just fired.

The event at the top of the list is the next one due to fire. It is highlighted with a light red background, whereas the other events in the list are normally highlighted with a light green background.

If you click on an event in the list to select it for an action, such as to move, delete, or disable it, the event text changes from black to white. Multiple events can be selected using the Shift or Ctrl keys, as in normal Windows operation.

If an event is disabled it will show in the list as red text on a white background. An example of this is shown later.

Moving Items

Events in the schedule must fire in sequence. This means that two events scheduled to fire at the same time will still fire one after another, in the sequence they are listed on the *Scheduled Events* tab. If you have two (or more) such events and need to fire them in a specific sequence, you can adjust their relative positions in the list. If you highlight one of two (or more) events scheduled for the same time, one (or possibly both) of the *Move* buttons (*Move Up* and *Move Down*) will become active. Clicking *Move Up* moves the position of the event one place higher up the screen, whereas *Move Down* does the opposite. The buttons will be disabled (grayed out) if the event highlighted is scheduled for a different time than the one in the direction that the button would move it if enabled.

Deleting Items

Just as you can delete events from the *Event Manager* tab, you can also delete events from the *Scheduled Events* tab. But the choices are a little more complicated. Highlight an event on the *Scheduled Events* tab, click *Delete* (or select *Schedule>Del From Schedule* from the menu) and the following dialog pops up:

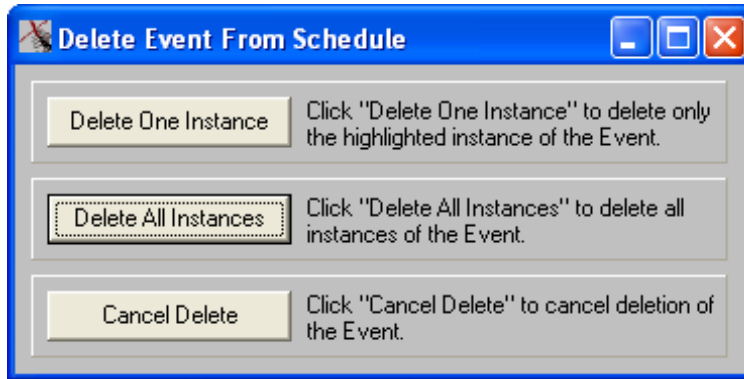

The choices are clearly explained on the dialog box. Click the appropriate button.

Enabling And Disabling Items

You can disable all instances of an event from the *Scheduled Events* tab. This will prevent the event from firing but will not delete it from the schedule. The event can later be enabled. Select an event and click the *Enable/Disable* button or select *Schedule>Enable / Disable* from the menu. A dialog box asks you if you want to disable all instances of the event:

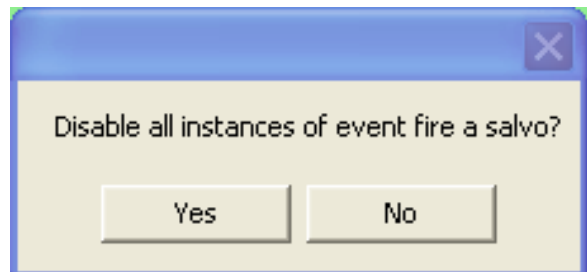

Click *Yes* to disable all instances of the event, or *No* to cancel the delete.

You can select multiple events from the list using the normal Windows techniques with the Shift and Ctrl keys. You will be prompted individually for each event you have selected.

Here is a section of the *Scheduled Events* tab showing a few disabled events:

1	connect 1 to 1	Wed	02/03/2010	12:00:00 AM	Connect 00400001() to 00400001()
2	connect 2 to 1	Thu	02/04/2010	06:00:00 AM	Connect 00400002() to 00400001()
3	disconnect 1	Thu	02/04/2010	11:00:00 AM	Disconnect 00400001()
4	fire a salvo	Thu	02/04/2010	06:00:00 PM	Fire Salvo Salvo 1(1)
5	fire another	Thu	02/04/2010	06:00:00 PM	Fire Salvo Salvo 2(2)
4	fire a salvo	Thu	02/04/2010	08:00:00 PM	Fire Salvo Salvo 1(1)
5	fire another	Thu	02/04/2010	08:00:00 PM	Fire Salvo Salvo 2(2)
4	fire a salvo	Thu	02/04/2010	10:00:00 PM	Fire Salvo Salvo 1(1)
5	fire another	Thu	02/04/2010	10:00:00 PM	Fire Salvo Salvo 2(2)
1	connect 1 to 1	Fri	02/05/2010	12:00:00 AM	Connect 00400001() to 00400001()
3	disconnect 1	Fri	02/05/2010	11:00:00 AM	Disconnect 00400001()
5	fire another	Fri	02/05/2010	06:00:00 PM	Fire Salvo Salvo 2(2)
5	fire another	Fri	02/05/2010	08:00:00 PM	Fire Salvo Salvo 2(2)

To re-enable an event (or events) the process is similar. The prompt dialog asks if you want to enable all instances of the event.

Exiting With A Schedule Running

Obviously, the software can only fire events from the schedule when the software is running. If a schedule is running and you close the program the following prompt will appear:

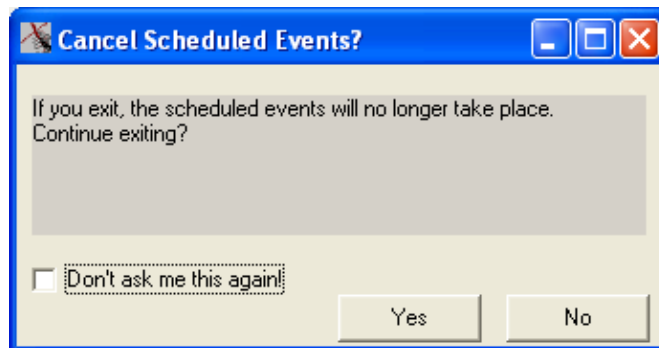

Clicking *Yes* will close the program, with the result that any as yet unfired events in the schedule will not be fired. Clicking *No* will dismiss the prompt and the program (and schedule) will continue to run. If you are tired of seeing this screen at program exit, check the *Don't ask me this again!* check box. The software will then no longer warn you at program close.

More On Exiting

Upon exiting the program you will see the following prompt:

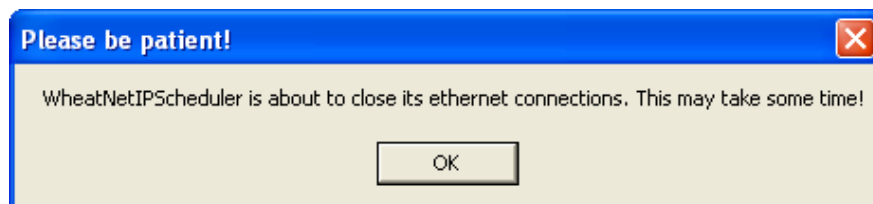

The program may continue running for a short time after all its windows disappear as it shuts down device connections.

Logs

The WheatNet-IP Scheduler program automatically keeps logs to indicate various types of activity. The files are named `EventLog_weekX.log`, where the X can be a number from 1 to 4. Upon program exit, log data from the current session is appended to the end of the currently active log file. Older logs are overwritten, so you need to look at the Date/Time stamp of the log files to determine which one is most current. Log files live in the same default location as the signal and event files previously discussed, typically `C:\<user>\Application Data\Wheatstone\WheatNetIPScheduler`.

Should you need to contact Wheatstone Technical Support regarding an issue with the software you may be asked to provide the logs.

Viewing Logs

The current log may be viewed by selecting *View Log* from either the *Events* or the *Schedule* menu item, or by clicking the *View Log* button on the main window. A typical log when viewed shortly after the program starts might look like this:

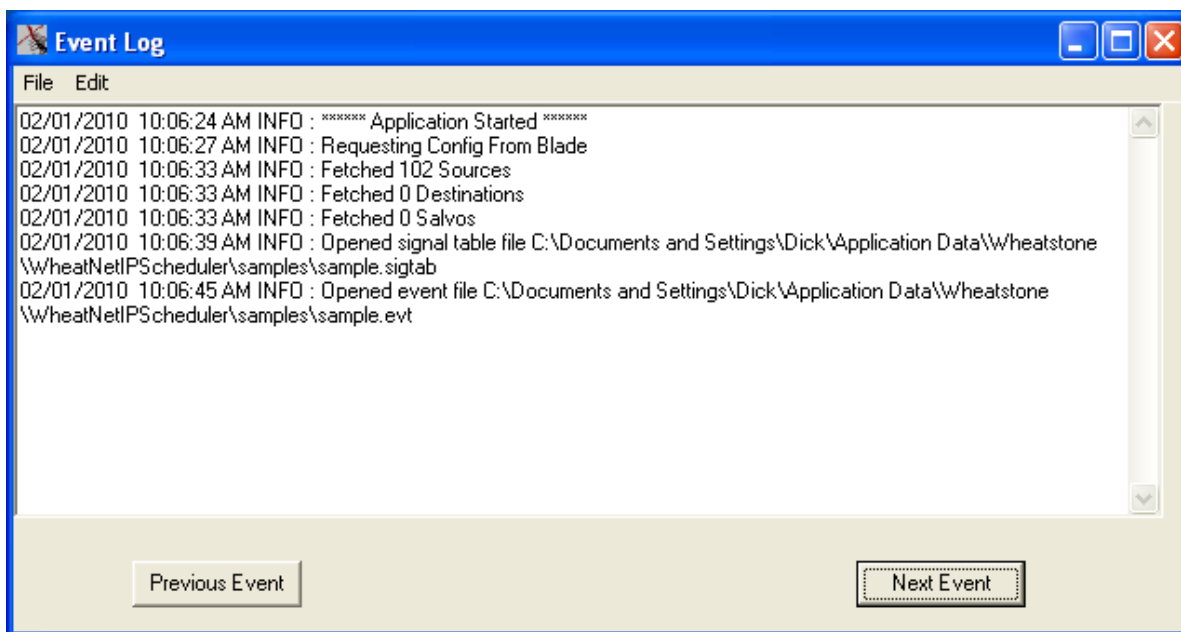

Also added to the log file are indications of events that have fired, requests for fetching signals, opening and saving event and signal files, and other useful information.

If any events have fired, they will be listed in the log. Any such listing contains the text "EVENT". This keyword is used when clicking the *Previous Event* and *Next Event* buttons to find all such listings in the log.

Since the log files are plain text files, they can also be viewed in any simple text editor.

Menus

The WheatNet-IP Scheduler software is operated using buttons and menus. This section serves to bring together the descriptions of the various menu items that have been described throughout the manual. Some items in the main menu depend on which tab is being viewed and what items on that tab are highlighted. The small menu on the log form is described at the very end of this section.

File

The *File* menu contains a few items that are necessary for basic program configuration and operation. The available items are:

Open... – This item allows you to open a previously saved set of events for editing and/or scheduling.

Save... – This item allows you to save the current set of events for later use.

Set IP Address... – This item allows you to specify the BLADE 3 that you expect to connect to for obtaining signals and as the avenue by which your fired Connect, Disconnect, and Salvo events will control the system.

Define Devices – This item allows you to specify the device or devices that you expect to connect to for firing ACI events.

Request Config – This item allows you to fetch the signals known to the BLADE 3 to which you are connected – the program’s existing signal set is deleted first, so you may want to save a signal set before fetching a new one.

Print... – When selected while viewing the *Event Manager* tab, allows you to print the contents of the event list – when selected while viewing the *Scheduled Events* tab, allows you to print a snapshot of the current schedule list (events that have already fired will not appear on the printout).

Exit – This item allows you to close the Scheduler software.

Edit

The *Edit* menu contains a couple of items that can be useful in creating new events that are similar to existing events. This menu is only usable on the *Event Manager* tab. The available items are:

Copy – This item will copy the *Start Time* and *Repeat Interval* of the currently highlighted event to the clipboard, with a *Name* like “Copy of This Event”, assuming the *Name* of the event copied is “This Event”.

Paste – This item will paste the contents of the clipboard into the next available line on the event list.

Events

The *Events* menu is only visible when viewing the *Event Manager* tab. It contains items useful in managing the creation and editing of events. The available items are:

New – Calls up the *Event Properties* dialog with the first available undefined event showing.

Edit – Calls up the *Event Properties* dialog with the currently selected event showing – if multiple events are highlighted, the last one selected is the one that will be showing.

Delete – Begins the delete process for the event(s) highlighted – when an event is deleted from the *Event Manager* tab it is removed from the event list, and all scheduled instances are removed from the schedule list.

Schedule – Adds the highlighted event(s) to the schedule, at all scheduled times indicated by the *Event Properties*.

Schedule All – Regardless of event(s) highlighted, adds **all** events to the schedule at all scheduled times indicated by the *Event Properties*.

View Log – Calls up the *Event Log* window.

Schedule

The *Schedule* menu is only visible when viewing the *Scheduled Events* tab. It contains items useful in managing the scheduling of events. The available items are:

Move Up – If the currently highlighted event is scheduled at the same time as the event immediately above it in the schedule list, moves the highlighted event up so it will fire first.

Move Down – If the currently highlighted event is scheduled at the same time as the event immediately above it in the schedule list, moves the highlighted event down so it will fire second.

Del From Schedule – Begins the delete process for the event(s) highlighted – when an event is deleted from the *Scheduled Events* tab it is **not** removed from the event list – you can also specify whether all scheduled instances are removed from the schedule list, or only the highlighted instance.

Enable / Disable – Toggles the “firing state” of the highlighted event(s) in the schedule, at all scheduled times indicated by the *Event Properties*.

View Log – Calls up the *Event Log* window.

Signals

The *Signals* menu contains a couple of items that can be useful in managing signal lists. The available items are:

Open Signal File... – Opens a previously saved signal set file – this is useful if you want to do offline editing of events without being connected to a BLADE3 – allows you to use the same signal set the software will be working with when connected to the target system.

Save Signal File... – Allows you to save the signal set in current use to a file – the file can be loaded to do offline editing – you can also print the file (after opening it in a standard text editor) for printed documentation of your system’s signals.

Help

The *Help* menu contains a couple of useful items:

Next Steps – Displays a message box with some quick hints on using the software.

About – Reveals the Version number of the software.

Event Log Menu

The *Event Log* window has a small menu to help perform some useful tasks.

Event Log Menu – File

The *File* menu on the *Event Log* window contains a few items that are helpful in working with logs. The available items are:

Save as... – This item allows you to save the current contents of the *Event Log* window to a file without removing the text from the window.

Purge to File... – This item allows you to clear the *Event Log* window – the current contents of the window are appended to the end of the currently active `EventLog_weekX.log` file. A brief line is added to the now clear *Event Log* window indicating the date and time the window was purged and what file the data was appended to.

Print... – This item allows you to print the contents of the *Event Log* window.

Exit this item closes the *Event Log* window – it does not close the Scheduler software.

Event Log Menu – Edit

The *Edit* menu on the *Event Log* window contains one additional item useful in working with logs:

Copy – This item copies any highlighted text in the *Event Log* window to the Windows clipboard – from the clipboard the text can then be pasted into another application, such as a text editor – this is useful when you want to copy some data from the *Event Log* window, but don’t want the entire contents.

Appendix 8

Contents

WheatNet-IP PC-XY Software Configuration Guide	A-103
Overview.....	A-103
Installing The Software	A-103
Network Considerations	A-103
Logging In.....	A-104
Menus.....	A-104
Setting BLADE3 IP Address.....	A-104
Using Source / Destination Windows.....	A-105
Logging Out.....	A-105
Visibilities.....	A-105
Hot Button Programming	A-106

WheatNet-IP PC-XY Software Configuration Guide

Overview

PC-XY is an easy to use PC application that facilitates audio and logic cross point control of a WheatNet-IP audio network. The software connects to any host BLADE3 in the system via the PC's Ethernet connection and provides customizable routing of audio or logic.

Source and *Destination* windows display user defined signal lists that give the broadcast engineer tight control over access to system resources. Eight fully programmable “hot” buttons can act as source selectors for rack room or desktop speakers, control room to air chain selectors, recorder source selectors – the possibilities are endless.



Installing The Software

WheatNet-IP PC-XY is a Windows platform program and runs on XP, Vista, or System 7. Installing the software is easy. Simply run the executable installation application and follow the installation prompts.

Once installation is completed you will be asked for a License Key. You can choose to run the software free for 14 days or contact customer support at 252-638-7000 or techsupport@wheatstone.com to get your license key emailed to you.

License keys are good for installing the product on multiple machines for up to seven days. The program will continue to run on the machine it is installed on, it is just the installation license key that expires.

Network Considerations

The PC-XY program communicates to the WheatNet-IP system over an Ethernet network. The PC hardware requirements are “bare bones minimal”. The PC's network card can be Fast Ethernet (10/100BTX) or Gigabit (1000BT). The PC must have an IP address on the WheatNet-IP system's subnet or have been routed there by your IT administrator.

Multiple PC-XY's

You can run multiple instances of PC-XY on one PC, each with unique buttons and visibilities. Each instance will share the same password.

- Copy the “*bin*” folder, from your current install folder: C:\ProgramFiles\Wheatstone\WheatNetIpPCXYGui\bin
- Put “*bin*” inside a new folder in the Wheatstone folder.
- Create a shortcut to the new PC-XY.exe file location.

Logging In

When PC-XY is first started you must log in to set a password and make various configuration changes. Right click on the PC-XY front panel to open the *Login* form. Click *Ok* to log in for the first time.

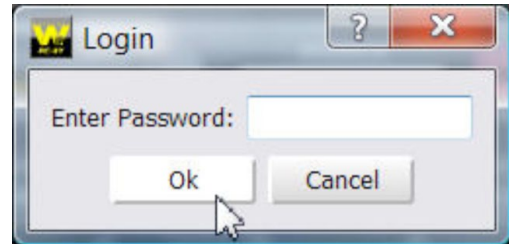

The default PASSWORD is **blank** when you install the program.
Just click *Ok* to Login for the first time.

Menus

You may access the menu tree at any time by right clicking anywhere on the PC-XY controller. If you are not logged in you will be prompted to *Login*. Most menu choices are self explanatory. The following is a brief description of the key choices.



Sort Signals...

By Id – Sorts all signals in linear Blade ID order.
By Name – Sorts alphabetically - system wide.

Visibilities... – Create custom Source/Destination lists.

Change Password... – Modify password here.

Set IP Address... – Select a BLADE 3 that PC XY will use as an access point to the system's signal map.

Logout... – When you logout users can freely use PC-XY controls but can not program any changes.

Setting BLADE 3 IP Address

This step lets PC-XY use a BLADE 3 in your system as an access point so it can gather *Source* and *Destination* names and also make cross points. Start by selecting *Set IP Address...* from the right click menu.

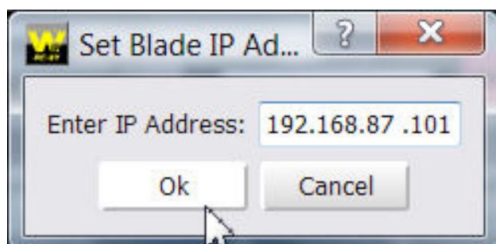

In order to communicate with the WheatNet-IP system you must tell PC-XY which BLADE 3 in the system you'd like it to talk to. You may select the IP address of any BLADE 3 in the system. Click *Ok* when done.

Once PC-XY establishes a connection with the specified BLADE3, you will see that the *LINKED* “LED” will turn bright green. *Source* and *Destination* signal names will also be available in the drop down lists.

Note that the *Visibility* controls, explained later, determine exactly which *Source* and *Destination* signal names are available to this particular installation of PC-XY.



Using Source / Destination Windows

These windows allow access to any number of sources and destinations.

- Use the *SOURCE* drop down list to select the audio input you would like to route.
- Select a *DESTINATION* from its drop down list.
- Press “*TAKE*” to complete the route.
- Customize lists with *Visibility* settings.



Logging Out

When you have completed the setup of PC-XY you can *Log Out*. When you log out, PC-XY continues to function however users can not edit any of the settings without the *Log In* password.

Visibilities

The *Set Visibilities* form allows the engineer to configure PC-XY so the end user “sees” a limited set of *Source*, *Destination*, and *Salvo* signals. This is where you limit what shows up in the drop down *Source* and *Destination* lists on PC-XY’s front panel. This function is useful when you wish to give non-technical users *Source* select control of a very limited number of sources and usually control of only a single destination – like a set of PC speakers or the input to a recording device.

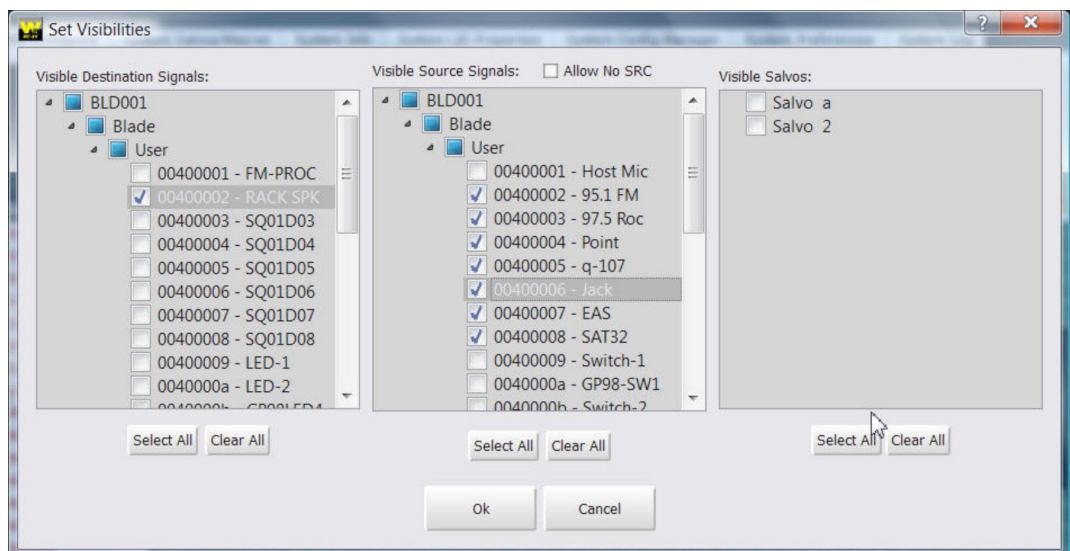

Simply select the signals you want *this* installation of PC-XY to “see” and click *Ok* when finished. PC-XY will boot with these settings. Setting a *Login* password will prevent unauthorized changes to the visibility lists.

Hot Button Programming

The eight *Hot Buttons* located along the bottom of the PC-XY front panel may be programmed to make dedicated cross points or fire salvos. Text typed in the *Legend* field will appear on the button. You may type approximately 10 characters before they are truncated.

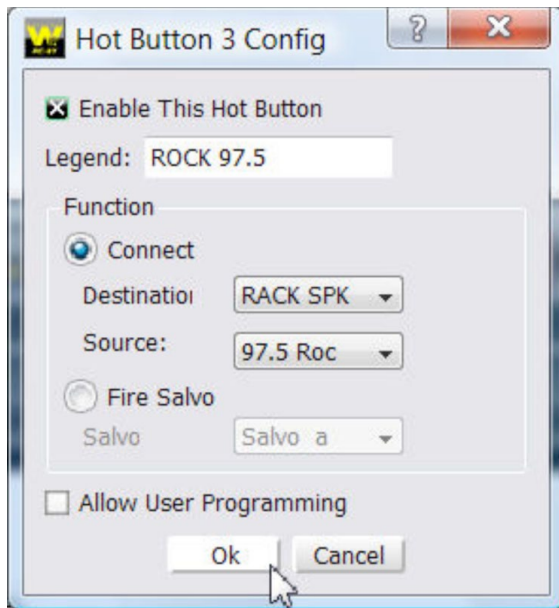

Right click on the button you want to program to open the button’s configuration form.

Enable... – Check this to activate the button for all users. Un-check *Enable* to disable the button but retain settings.

Legend: – Enter text to display on button face.

Connect – Select the cross point that will be “patched” when the button is pressed.

Fire Salvo – Choose a Salvo to be executed when the button is pressed. Salvos are simply a list of multiple cross points that are simultaneously triggered. Salvos must be pre-configured in WheatNet-IP Navigator software.

Allow User Programming – Check this if you want to let users edit Hot Button settings without logging in.

Appendix 9

Contents

Introduction to Screen Builder.....	A-108
-------------------------------------	-------

Introduction to Screen Builder

While not built into a BLADE 3, the screen builder app offers the scripting capability of a GP-16, the control of GlassE, monitoring and metering of the IP Meters app, and ACI protocol. This will allow a user to build a custom screen to fit many needs in specific applications. It will work with any version BLADE.



Build your own on-screen virtual control interface for just about any purpose. Our new Screen Builder app has faders, meters, labels, buttons, knobs, clocks, timers, and other widgets that you can arrange on a PC screen to create your own custom control panels and touchscreens, with quick-access buttons, faders and meters for level adjusting and monitoring, and more. Drag, drop and assign values to each widget.

Add your own graphics and logos, even images. Custom panels made with Screen Builder have access to our complete AoIP network, the WheatNet-IP Intelligent Network, and all of the BLADE 3s, control surfaces, processors, and partner devices on it, so you are only limited by your imagination. Once created, your custom panels and touchscreen interfaces can be password protected to prevent unauthorized manipulation of the special graphics and functions you've designed.

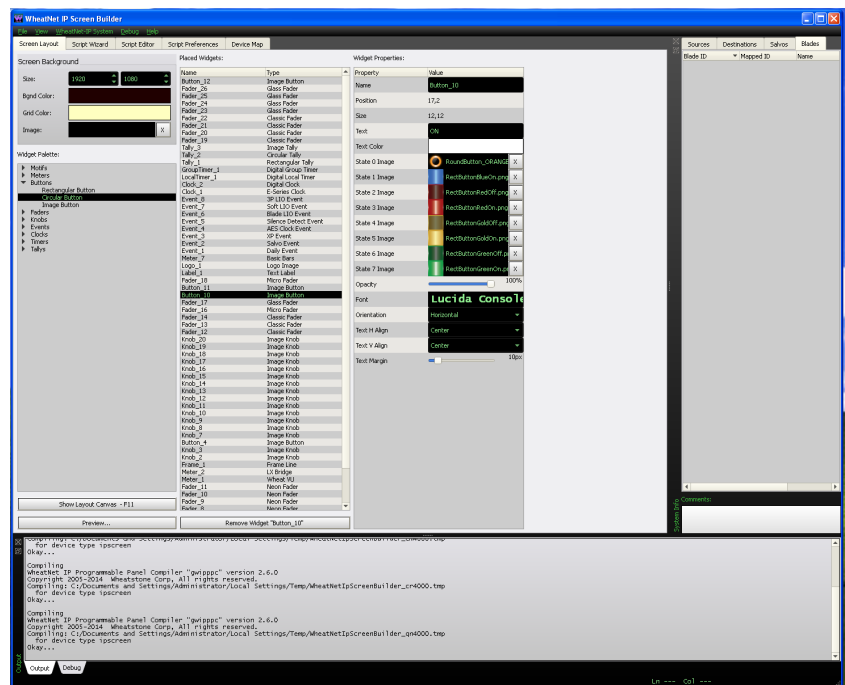

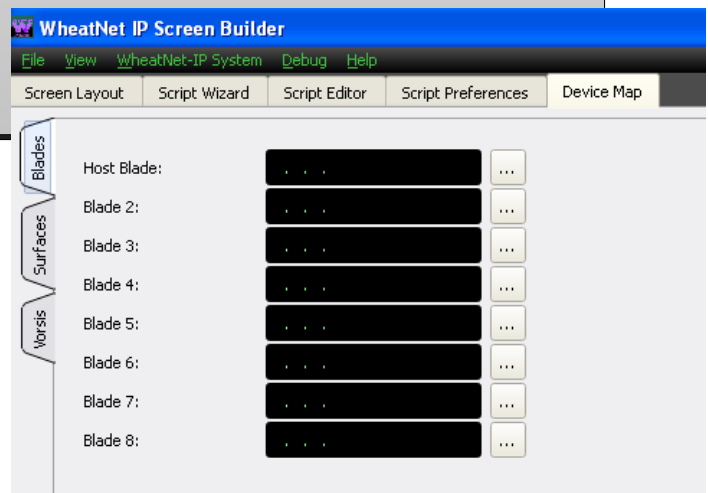
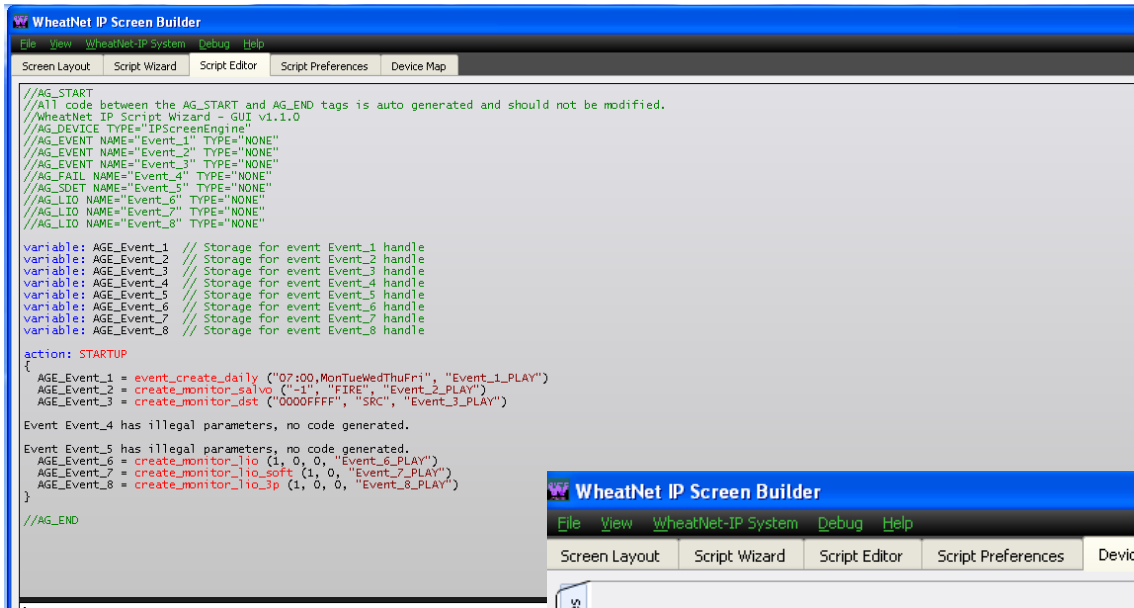
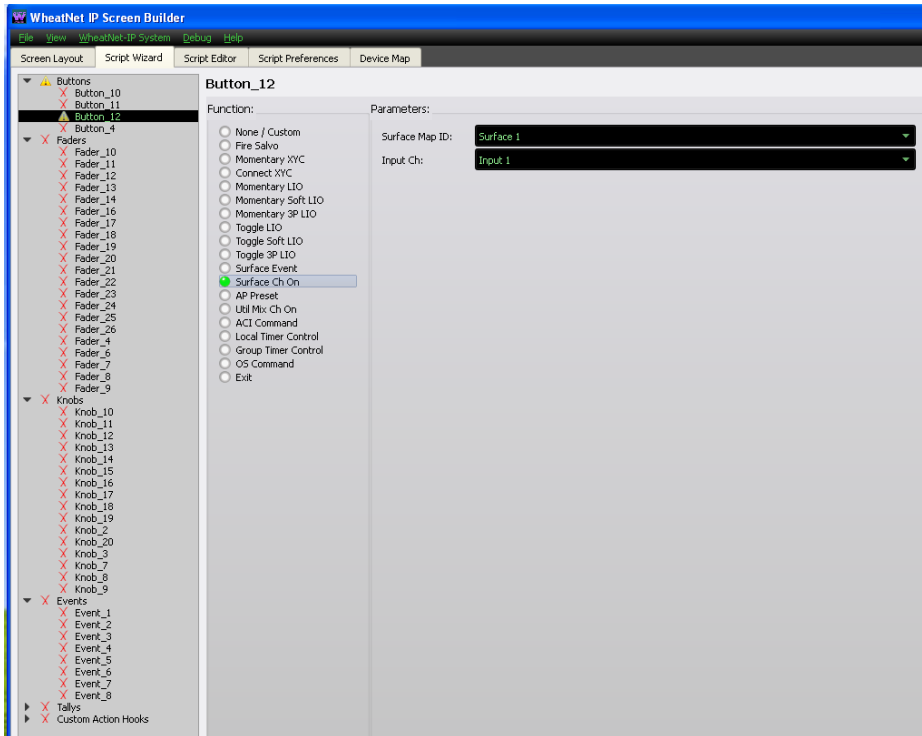

Appendix 10

Contents

Introduction to OLED Switch Panels	A-111
--	-------

Introduction to OLED Switch Panels

Our new Scriptable Multi-Switch Panels include our versatile scripting engine and up to eight switches, each of which has a multi-colored graphical OLED display, for customizing WheatNet-IP access and control. Our easy scripting menu lets you map devices and functions to each switch for firing salvos, establishing network crosspoints, toggling between ON/OFF, and more – all of which can be represented in graphical and colorful detail on OLED displays. OLED Switch Panels are available to fit your favorite rack or can be dropped, as modules, into your LX-24, L-8 or L-12 for creating the ultimate control surface.



Appendix 11

Contents

WheatNet-IP and AES67	A-113
System Requirements	A-114
Timing.....	A-114
Packet Structure.....	A-115
Multicast Address Change	A-116
Ports	A-116
Using WNIP with AES67.....	A-117
Example 1: Bringing in audio streams from an Axia xNode using 1/4ms packet timing.....	A-121
Example 2: Bringing in audio streams from an Axia xNode using 1ms packet timing.....	A-125
Example 3: Sending a WNIP audio stream to an Axia xNode using 1/4ms packet timing.....	A-128
Example 4: Sending a WNIP audio stream to an Axia xNode using 1ms packet timing.....	A-131
SDP Files	A-133
Summary	A-135
Some Screen Shots of Various Vendors Configuration Screens.....	A-136

WheatNet-IP and AES67

WheatNet-IP is compatible with and can successfully stream to and from AES67 devices made by other manufacturers. WheatNet-IP supports two AES67 packet timings (more on this later), 1ms and 1/4ms.

First a brief overview. WheatNet-IP and most other audio-over-IP technologies (AES67, Livewire, Ravenna, Dante, etc) are based on using common IP protocols for identifying, parsing, transmitting, and routing digital information over an IP network. This is no coincidence because all of these AoIP technologies depend on using standard off the shelf network switches to move packets around the network. We must use protocols these switches understand if they are to be useful for this.

We speak of “packets” when talking about AoIP because that is how IP networks work. Any information that is transmitted on an IP network whether its a print job, email, a browser session, or AoIP is first broken down into discrete digital pieces, each representing a very small part of the entire “message”. These discrete pieces of digital information are put together in a specific order with standardized blocks of identification information (specified by the IP protocol); the assembly of identification and digital information is then called a “packet” and any IP network device knows how to transmit and receive these “packets”.

Thus any content of any kind sent over an IP network is broken down into individual fragments sent one piece at a time and reassembled by the receiving device into useful information. As long as the sending device, network switches, and receiving device all use the same rules for this process it all works. These “rules” are what is referred to as the “IP Protocol”.

It is very important to understand this point: network switches have no special functions or structure that is made for routing audio. To the switches, packets are much the same whether they are AoIP, video, email, or a print job. It is the data within the packets that is unique.

Wheatstone, in the process of developing WNIP, has taken audio that is input into a Blade, digitized it into digital pieces and inserted these digital pieces as the payload into standardized packets that use these IP protocols.

So have the other vendors of AoIP systems. So what makes them different from each other?

As far as sending and receiving IP audio streams, not much at all. Yes there are huge differences relating to control and discovery and special features like mixing and processing, but for the actual stream itself very little, mostly having to do with the specifics of the payload within the packets themselves.

The Audio Engineering Society, recognizing this fact and wanting to create a standard that would allow different AoIP devices to stream with each other came up with the AES67 standard, which describes the IP protocols to be used to identify and route the packets and also describes some standard ways to put together the digital pieces of audio information in the packet payload.

The theory is that if a device uses the prescribed protocol in the packet header to identify them and fills the packet payload in the prescribed manner, other devices will be able to receive the packet and reassemble the payload into the correct audio signal.

In fact this works and the rest of this chapter is about how to use WNIP Navigator to send and receive streams with other devices configured to the AES67 standard.

System Requirements

Timing

One of the key problems AES was faced with when creating the standard was how to keep disparate audio devices all synchronized so audio would playback without clicks and pops due to sample rate and timing mismatches. Here's the problem – in WNIP Blades all synchronized their internal clocking to a special signal that the system distributes to every Blade. We call that signal the “metronome” and we send it around the network many times per second to keep all of the individual clocks in Blades that actually play out audio in sync with each other. We developed this method of synchronization back in 2004 when we started making WNIP. Axia did something on their own with Livewire for the same purpose, and other vendors did yet something else. We each did our own thing because back in the day there was nothing suitable for the purpose; we had to invent something to make it work.

Natively WNIP can't synchronize an xNode and vice versa. Same with the others because we all use our own inventions for the purpose. AES67, in recognition of this difficulty, specifies a method to share synchronization amongst devices, a standard timing protocol that has come out in recent years; IEEE-1588, also known as the **Precision Time Protocol**, or PTP. In fact the standard specifies a particular version of this protocol known as PTPv2.

So for an AoIP system to maintain timing and stay synchronized with other AES67 devices, the system timing must be controlled by PTPv2. For that to occur there must be some device in the system that serves the role as PTPv2 timing generator to which all other devices slave their timing. Generally that role is filled by a specialized PTP master clock device because the PTPv2 protocol is so precise that in the best circumstances (PTPv2 master clock synced to GPS for absolute timing reference and PTP aware switches used for reference signal distribution) timing accuracy of better than 1 microsecond can be achieved. An ordinary crystal oscillator in a PC or I/O device is nowhere near accurate and stable enough for this performance level, hence the need for stand alone Master Clock generators.

Sub-microsecond timing accuracy is not required to maintain click free audio however, so if your main concern is clean audio and you're not worried about absolute timing accuracy you can dispense with the added expense of PTP aware switches and use a basic PTPv2 master clock. Some AoIP devices will actually provide a PTP reference clock signal themselves, however their timing accuracy is typically poor.

Bottom line – To use AES67 devices your system must have a PTPv2 clock reference device.

Packet Structure

We spoke earlier of how an AoIP packet gets created; the transmitting device creates a packet header using the standard IP protocols and the payload gets filled with pieces of digital audio data which will get put back together by the receiving device to recreate the audio signal.

It's important that the transmitting device and receiving device use the same system for filling and decoding the payload for this all to work properly. There are many different ways this can be done:

- Fill the payload with one audio sample of data; for instance left channel, 24 bits. Send another stream with another 24 bits, in this case the right channel. While this would in fact work, it is a very very inefficient and difficult system because it would take 96,000 packets per second to make one stereo audio stream sampled at 48K.
- Fill the packet with 12 samples of 24 bits of left channel audio and then 24 bits of right channel audio.
- Fill the packet with 12 samples of 24 bit audio, interleaving left and right channels.

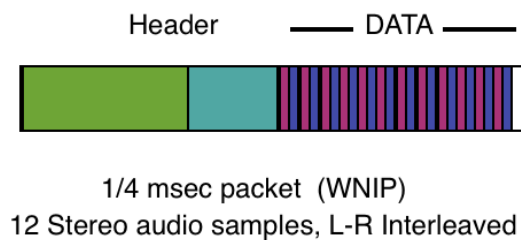

- Fill the packet with 48 samples of 24 bit audio, interleaved.

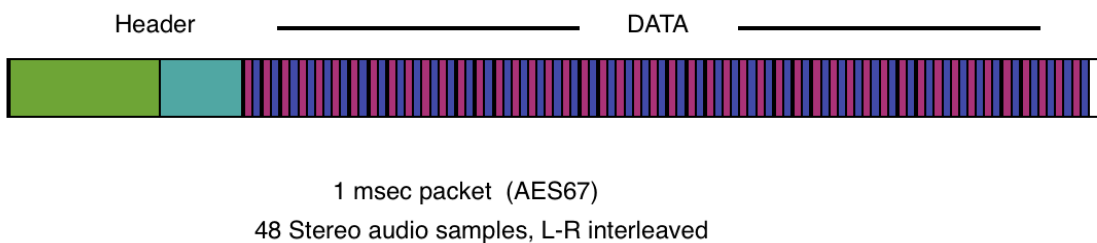

- Fill the packet with 64 samples of 16 bit audio, interleaved.
- Fill the packet with 96 samples of 24 bit audio, mono.

You can see the possibilities are nearly endless, so what AES67 does is to specify a single packet structure that must be used; this is the 1msec packet timing you see in all of the specifications and it equates to 12 samples left-right interleaved in a stereo stream.

By the way, AES67 goes on to specify some additional packet structures that could be used because there is no one right answer for the ideal structure. The problem is that larger packet structures are more efficient for the network infrastructure because fewer packets are needed to stream, but larger packets induce greater latency because it takes longer to fill a big packet with 48K audio data samples than a small one. In fact WNIP uses gigabit Ethernet connections and 1/4msec packet timing as our default to keep latency to a minimum.

Multicast Address Range

Streams that are intended to be sent to more than one device take advantage of a standard IP mechanism, multicasting, to maximize network efficiency. In this protocol every stream is given a unique multicast address to identify it on the network so standard switches can send its packets to the devices that want them, but not to devices that don't want them.

The number of available multicast addresses is very large and individual device manufacturers could chose any of these multicast addresses to use in their system. AES67 specifies a particular range of addresses that must be used in order to assure potential compatibility.

Ports

Ports provide a mechanism in IP networks of pre-identifying the type of information that will be contained in the payload of a packet. For instance an smtp email message will be directed to port 25 so the receiving device automatically knows to forward the payload data to the email application without having to decode the actual payload to figure out what it contains.

AoIP is similar in that it is desirable to forward the payload data directly to the AoIP streaming application. Of course different vendors have chosen their own ports to use: AES67 specifies a standard port, 5004, that all devices should be capable of using.

Conclusion: By providing specific configuration details for AoIP streams, AES67 makes it possible for devices that adhere to these details to stream audio between them. Since vendors of AoIP devices may have existing systems that were built before there was an AES67 standard and will want to maintain streaming capability with their own equipment, there must be a mechanism to specify these details on a case by case basis as the needs arise. In WNIP this is done via the Navigator software application. Other AoIP vendors have their own mechanisms to use to alter their device configuration parameters and you'll need to be familiar with and use each venders methods for the AES67 devices you'll have in your system.

Using WNIP with AES67

Since AES67 only specifies stream content parameters and does nothing to manage stream discovery and control, these functions must be managed manually. To put it another way, since AES67 does not include a standard way for AoIP streams to be identified there is no way for a device from vendor A to “see” or know about a stream from vendor B. And if you can’t “see” an available stream, you can’t receive it. The current work around for this problem is to specifically tell device B that there is a stream from device A available with such and such parameters that it should start receiving. This is purpose of the SDP (Session Description Protocol) mentioned in the AES standard. Not only does the standard specify the parameters in an AES67 stream, it also specifies how those parameters should be presented. So in fact, the system engineer becomes the audio router by manually telling which devices should listen to which streams.

This is a bit of work, but easy enough until you realize that because the different devices can’t “see” each other, it is entirely possible that they may be using address settings already in use elsewhere.

So the first step in putting together the system is to map out an IP and stream multicast address plan that assures every stream on every device will have a unique address available for it.

Multicast addresses are in the form of 239.xxx.yyy.zzz. Each AoIP vendor has their own way of allocating addresses for each stream. WNIP does it automatically but the user can change the starting address and range if needed. Axia uses “Livewire Channel numbers” but can also accept a manually entered address. Dante will let the user specify the xxx octet of the address but automatically generates the yyy and zzz without any user control of what it chooses. Other equipment may do this yet differently.

To make your stream multicast address plan you must know all the different devices that will be in the system and how they allocate multicast stream addresses. Start with the devices which are least common or least flexible in specifying or changing multicast addresses and isolate them in an address range well removed for what the majority of your devices will be. As an example, if you have a WheatNet-IP system with 50 BLADEs and you want to add two Dante devices to it, you would give the Dante device streams a multicast address of .192 for the second octet and check what multicast addresses Dante auto-assigns. Then have the WheatNet-IP devices auto-generate multicast addresses starting lower (239.192.192.1) or higher (239.192.yyy.zzz+10) to make sure there are no WNIP streams assigned the same multicast addresses.

It’s important to go through this effort to create a plan first, because as you add AES67 devices to your system you will be doing a lot of hand entry specifying which stream addresses which device is using to transmit on and which stream address each device is using to receive. If you go through all this effort only to discover that some other device is using that same address you’ll only have to start over. Besides, having your multicast address plan in place will be useful later when you are routing AES67 streams in your network; you’ll refer to it over and over again.

With a multicast address plan in place lets begin.

With the WNIP system up and running and the Navigator application running on your administration PC, open the System Info tab. You'll see a screen that looks like this:

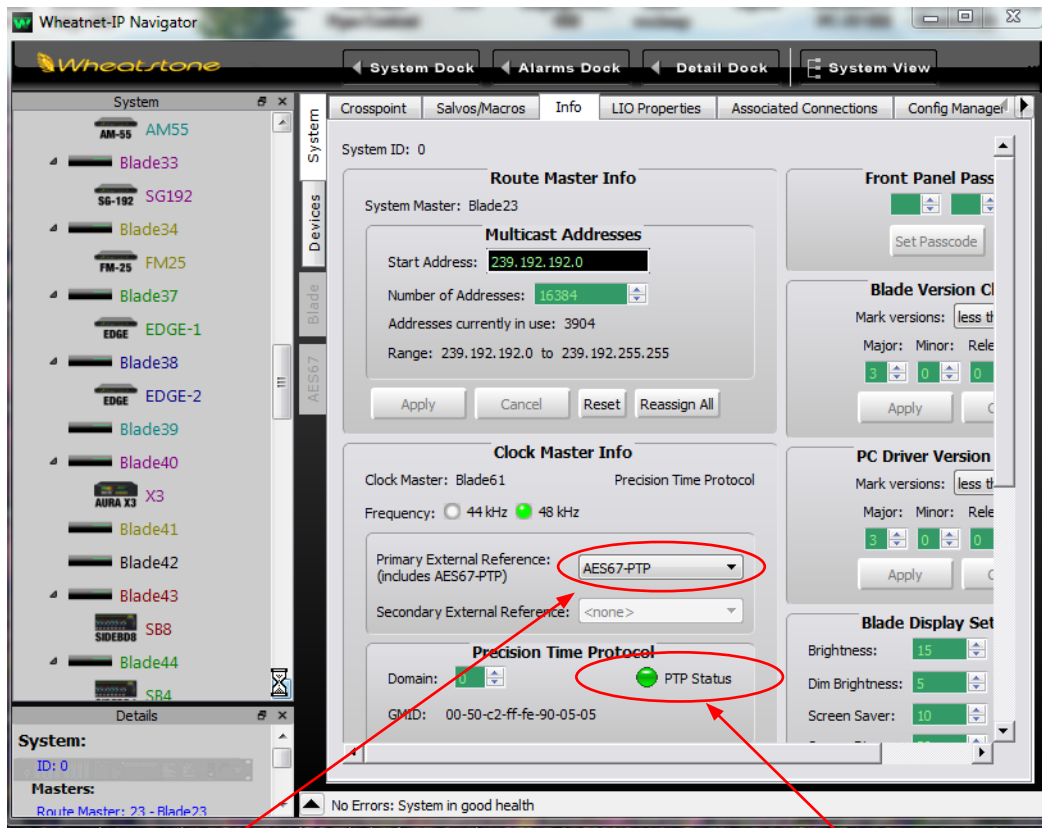

Click on the drop down and select AES67 PTP as your clock reference. If this is the first time you've enabled AES67 PTP you will be promoted to apply for a license; copy the seed key information and forward it to techsupport@wheatstone.com. They will supply you the necessary license which is required because of licensing and Patent issues incorporated in the AES67 standard.

If you have installed and are running a PTPv2 master clock, Navigator will detect it and show its status here. Note that if you have not installed a PTP master clock or WNIP cannot see it then AES67 devices will not work. This status indicator is also useful when your system is running to alert you; it will turn red and issue an alarm if PTP is lost.

Unless you know otherwise for certain you should set your system sample rate to 48K as AES67 does not require devices to support 44.1K and many do not.

The next step is to make note of the stream and address allocation within WNIP. You'll need this information to "tell" AES67 devices the information for the WNIP streams you want them to receive.

Click on the System Info tab on the Navigator screen and then choose Source Streams to open a window that looks like this:

Sig Id	Name	Location	Index	Multicast Address	Offset	Width	Port	Payload Type	Packet Rate	Encoding Type	Clock Type	GMID
53.1.8.8	Spare09	Blade53	0	0.0.0.0	0	Stereo	50100	100	0.25ms	24 Bit Interleaved	Precision Time Protocol	00-50-c2-ff-fe-90-05-05 0
53.1.8.9	Spare10	Blade53	0	0.0.0.0	0	Stereo	50100	100	0.25ms	24 Bit Interleaved	Precision Time Protocol	00-50-c2-ff-fe-90-05-05 0
53.1.8.10	Spare11	Blade53	0	0.0.0.0	0	Stereo	50100	100	0.25ms	24 Bit Interleaved	Precision Time Protocol	00-50-c2-ff-fe-90-05-05 0
53.1.8.11	Spare12	Blade53	0	0.0.0.0	0	Stereo	50100	100	0.25ms	24 Bit Interleaved	Precision Time Protocol	00-50-c2-ff-fe-90-05-05 0
53.1.8.12	LXTIMER	Blade53	0	0.0.0.0	0	Stereo	50100	100	0.25ms	24 Bit Interleaved	Precision Time Protocol	00-50-c2-ff-fe-90-05-05 0
53.1.8.13	LXTALLY	Blade53	0	0.0.0.0	0	Stereo	50100	100	0.25ms	24 Bit Interleaved	Precision Time Protocol	00-50-c2-ff-fe-90-05-05 0
54.0.3.0	BL54UMXA	Blade54	0	239.192.217.144	0	Stereo	50100	100	0.25ms	24 Bit Interleaved	Precision Time Protocol	00-50-c2-ff-fe-90-05-05 0
54.0.3.1	BL54UMXB	Blade54	0	239.192.217.145	0	Stereo	50100	100	0.25ms	24 Bit Interleaved	Precision Time Protocol	00-50-c2-ff-fe-90-05-05 0
54.0.3.2	BL54UMYA	Blade54	0	239.192.217.146	0	Stereo	50100	100	0.25ms	24 Bit Interleaved	Precision Time Protocol	00-50-c2-ff-fe-90-05-05 0
54.0.3.3	BL54UMYB	Blade54	0	239.192.217.147	0	Stereo	50100	100	0.25ms	24 Bit Interleaved	Precision Time Protocol	00-50-c2-ff-fe-90-05-05 0
54.1.0.0	LX PGM	Blade54	0	239.192.217.148	0	Stereo	50100	100	0.25ms	24 Bit Interleaved	Precision Time Protocol	00-50-c2-ff-fe-90-05-05 0
54.1.0.1	LX AUD	Blade54	0	239.192.217.149	0	Stereo	50100	100	0.25ms	24 Bit Interleaved	Precision Time Protocol	00-50-c2-ff-fe-90-05-05 0
54.1.0.1	LX AUD	Blade54	1	239.192.219.36	0	Stereo	5004	100	1.00ms	24 Bit Interleaved	Precision Time Protocol	00-50-c2-ff-fe-90-05-05 0
54.1.0.2	LX AUX	Blade54	0	239.192.217.150	0	Stereo	50100	100	0.25ms	24 Bit Interleaved	Precision Time Protocol	00-50-c2-ff-fe-90-05-05 0
54.1.0.2	LX AUX	Blade54	1	239.192.219.38	0	Stereo	50100	100	1.00ms	24 Bit Interleaved	Precision Time Protocol	00-50-c2-ff-fe-90-05-05 0
54.1.0.3	LX OL	Blade54	0	239.192.217.151	0	Stereo	50100	100	0.25ms	24 Bit Interleaved	Precision Time Protocol	00-50-c2-ff-fe-90-05-05 0
54.1.0.3	LX OL	Blade54	1	239.192.219.40	0	Stereo	50100	100	1.00ms	24 Bit Interleaved	Precision Time Protocol	00-50-c2-ff-fe-90-05-05 0
54.1.2.0	LXAux1	Blade54	0	239.192.217.152	0	Stereo	50100	100	0.25ms	24 Bit Interleaved	Precision Time Protocol	00-50-c2-ff-fe-90-05-05 0
54.1.2.1	LXAux2	Blade54	0	239.192.217.153	0	Stereo	50100	100	0.25ms	24 Bit Interleaved	Precision Time Protocol	00-50-c2-ff-fe-90-05-05 0
54.1.2.2	LXAux3	Blade54	0	239.192.217.154	0	Stereo	50100	100	0.25ms	24 Bit Interleaved	Precision Time Protocol	00-50-c2-ff-fe-90-05-05 0
54.1.2.3	LXAux4	Blade54	0	239.192.217.155	0	Stereo	50100	100	0.25ms	24 Bit Interleaved	Precision Time Protocol	00-50-c2-ff-fe-90-05-05 0

This list shows all of the WNIP streams available in your system and gives information about their assigned IP and multicast addresses. You can sort the list by clicking on the desired column heading; one handy sort is to click on the multicast address heading and you will see the list of multicast addresses in ascending order. This makes it easy to see what the first and last addresses are so you can tell what addresses would be safe for an AES67 device that you'll be manually assigning.

You'll also use this list again and again to decide which multicast address you need to specify an AES67 device to receive. Since AES67 does not support stream discovery and connection management, you'll need to manually reassign multicast addresses to AES67 receiving devices each time you make a routing change (more on this later). In this example to receive the stream BL54UMIXA you must configure the AES67 device to receive 239.192.217.144.

Once your PTPv2 clock is running, Navigator is licensed for AES67 and you've noted your WNIP stream multicast addresses you can begin connecting AES67 devices to your system.

The first step is to decide whether or not you need to use packet timing translation with your AES67 devices. As noted at the beginning of this Addendum, WNIP uses 1/4ms packet timing for minimum latency. Most AES67 devices also support 1/4ms packet timing but some (namely Dante) do not. The best and easiest way to interface an AES67 device with WNIP is to use 1/4ms packet timing where ever you can. That way these devices will operate with minimal latency. If you have some AES67 devices that can use 1/4ms packet timing and some that can't, use 1/4ms for the devices that support it and 1ms for the others. You don't need to make every device run at 1ms just because you have one that won't.

In order to use an AES67 device running the base 1ms packet timing with WNIP you must enable packet timing translation functionality in WNIP. This packet timing translation can be performed by any analog, digital, analog/digital, or Aura8IP Blade in your system.

For packet timing translation, click on the Blade you want to use in the left hand pane of Navigator and then choose the Blade Info tab.

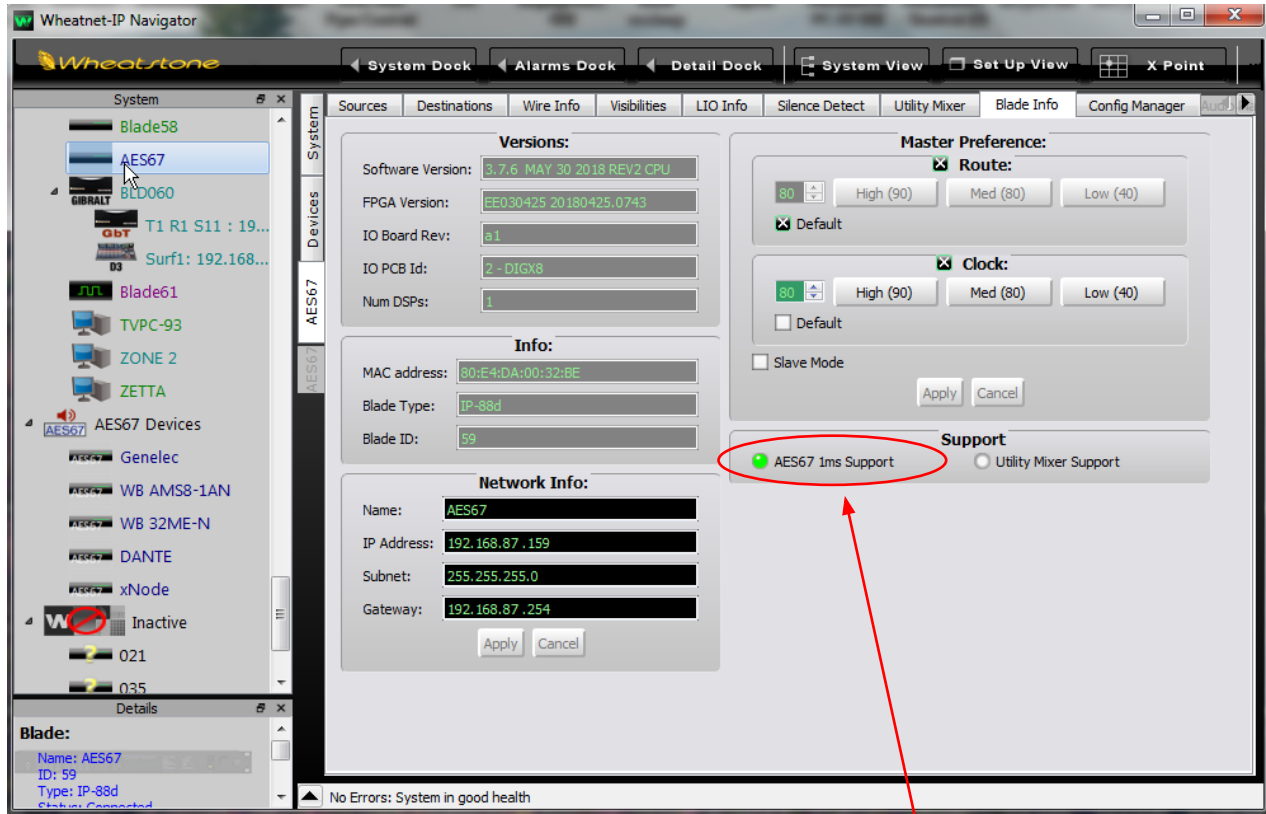

Choose AES67 1ms support for the Blade here.

Note that if AES67 translation services are used on a Blade it can no longer support Utility Mixers. It's an either - or thing, so its best to choose a Blade where UMixes are not being used nor are planned to be. A single Blade can provide packet translation services for as many as eight separate AES67 streams. If you need more than eight AES67 1ms streams translated you'll have to enable translation services on additional Blades.

Remember, you only need to enable translation if your AES67 device does not support 1/4ms packet timing; other than Dante this is rare.

All of this work has been in preparation for connecting to AES67 devices, now lets add in a device.

Example 1: Bringing in audio streams from an Axia xNode using 1/4ms packet timing

The first step is to set the xNode IP address into the WNIP system subnet.

- Open up a PC browser connection and log into the xNode. Consult your Axia documentation if you don't know how to do this. If the IP address of the xNode is not already on the WNIP subnet, as is most likely, your PC will need to connect directly to the xNode.
- On the system page of the xNode configuration window assign the xNode an IP address within the subnet range being used by WNIP (typically .87) but not used by any other device. Since WNIP Blades default to address 192.168.87.101 and up and WNIPsurfaces default to 192.168.87.201 and up, IP addresses below 192.168.87.100 are usually unused, the exception being the network switches themselves which usually start at 192.168.87.1. But since IP addresses can be changed from the defaults during the installation you'll need to know what the IP address range of your WNIP system actually is and What addresses are unused and available. The System view window from Navigator that we described earlier is a good way to see your IP addresses in use with WNIP. Just remember it shows WNIP addresses and not non-WNIP devices that could be running on your network.

The screenshot shows the 'IP settings' configuration window. It contains three input fields: 'Host name' with the value 'xnode900505', 'NET1 Network address' with the value '192.168.87.86', and 'NET2 Network address' with the value '0.0.0.0'. A red arrow points to the 'NET1 Network address' field with the text 'Set IP address here'.

IP settings:	
Host name:	xnode900505 (1)
NET1 Network address:	192.168.87.86 π
NET2 Network address:	0.0.0.0 π

- After you've entered a new IP address you must click on the "Apply" button to enable it. Of course as soon as you do that be mindful that the xNode will be on the WNIP subnet and your PC may no longer be connected to it until you add it to the subnet as well.
- Plug the xNode Ethernet to an available WNIP network switch port, and then click on the "Devices" tab on the left side of the Navigator screen. Choose the "AES67 devices" tab on the top. Here you manually add AES67 devices by choosing "Add" and filling in the device name and IP address and by choosing a WNIP Blade to act as the host for this device (any Blade will do up to a maximum of 20 devices per Blade).

Here is a screen showing a number of different AES67 devices that have been added to the system.

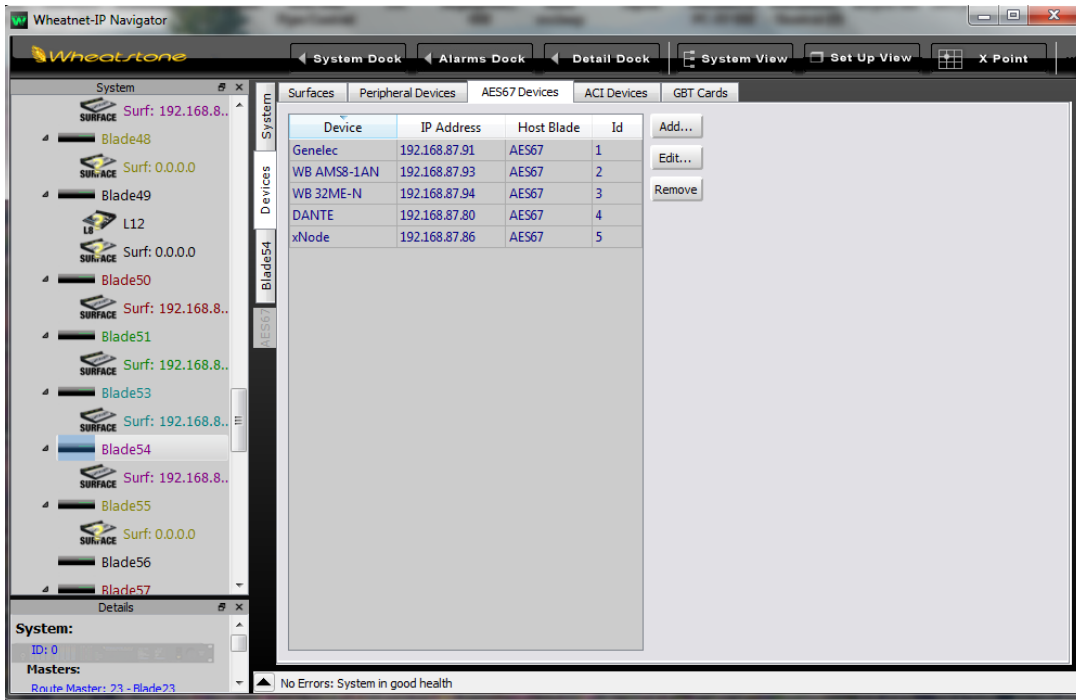

Once you have added the to the WNIP system, the next step is to specify the particular audio streams you want to have inter-operating between WNIP and your AES67 device. This is where you'll make use of the multicast address information you worked out previously. You'll need to configure both your xNode device and WNIP with this information; it makes no difference which you do first, only that you configure both with the same information.

Lets start with the xNode. Open a browser interface to the xNode (remember to use its newly configured IP address we set previously) and choose the "Sources" menu item.

You'll see a screen that looks like this. Here we've configured the four xNode channels to make AES67 compatible streams.

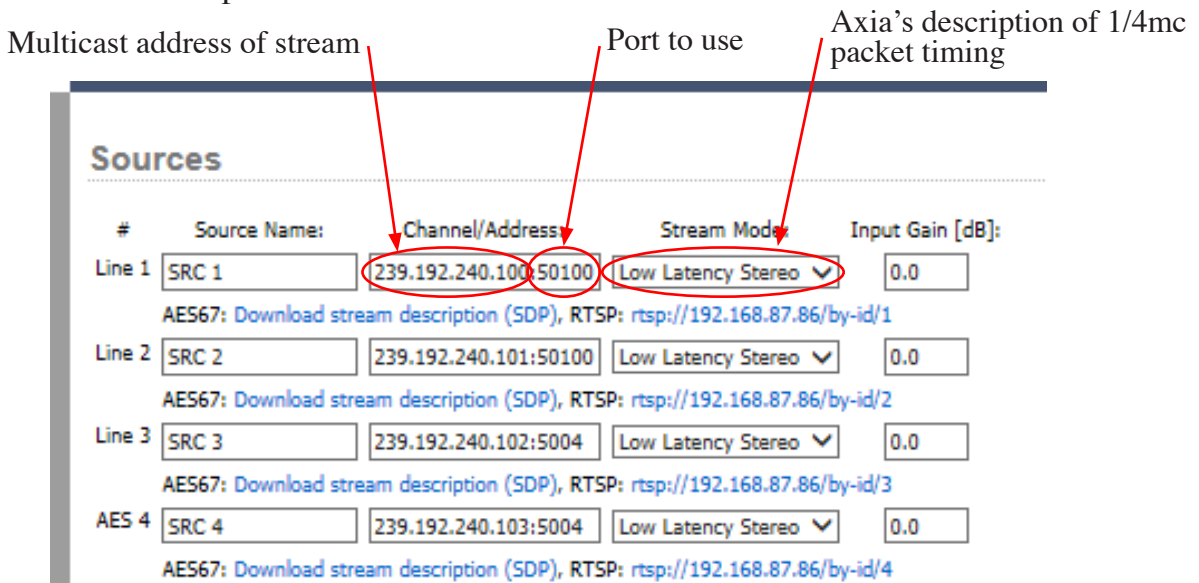

Off course, you'll need to use your own multicast address here. For the port you can choose the default WNIP of 50100 or the AES67 default of 5004 either will work as long as the WNIP side is configured to match.

Once you've configured your streams on the xNode, you can exit your browser session (don't forget to hit "Apply" first) and move on to the WNIP side.

In Navigator, click on the AES67 Devices tab and choose the xNode device you previously defined. Then click on the "Sources" tab. Here is where you define the streams to match what you defined for the xNode sources. Click on the "Add" button to define each stream (you can name it anything you like, this is the name that will show up in the Navigator crosspoint grid so choose a name that will be useful) and then click the "Stream Info" tab to open a window to define the stream parameters.

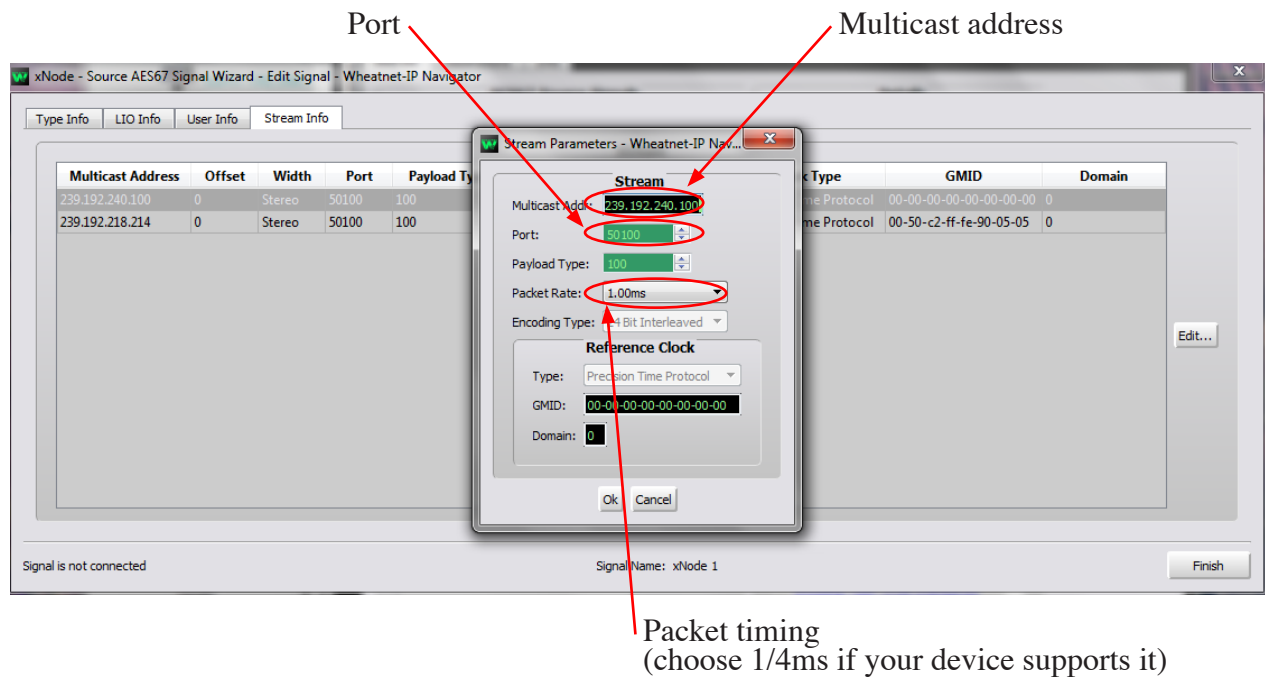

Be careful to match what you previously entered in the "Sources" window on the xNode; the WNIP definition here must match or you won't receive the stream you want.

Be sure to click "Finished" when you are done.

Repeat the process for each stream you want to use and when you are done, the Devices --->AES67 devices--->xNode--->Sources window should look something like this:

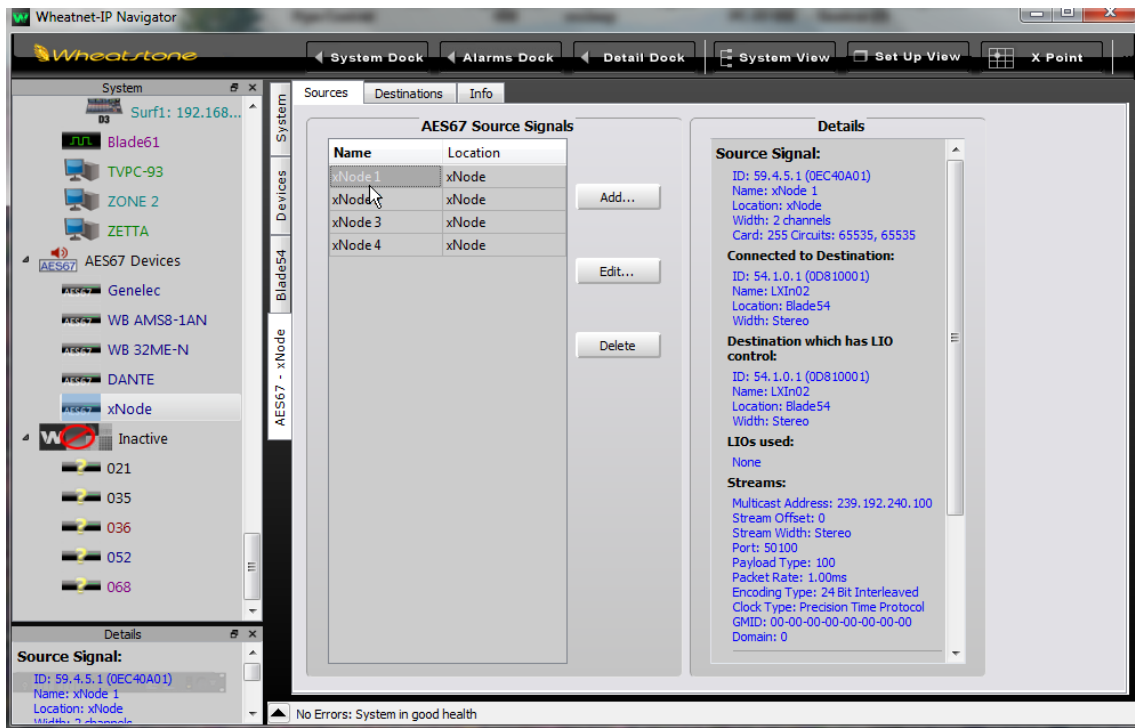

Your WNIP Navigator crosspoint grid will show these newly defined xNode sources ready to connect to any WNIP destination. Click crosspoints and your AES67 device will stream to the appropriate destination(s) in WNIP.

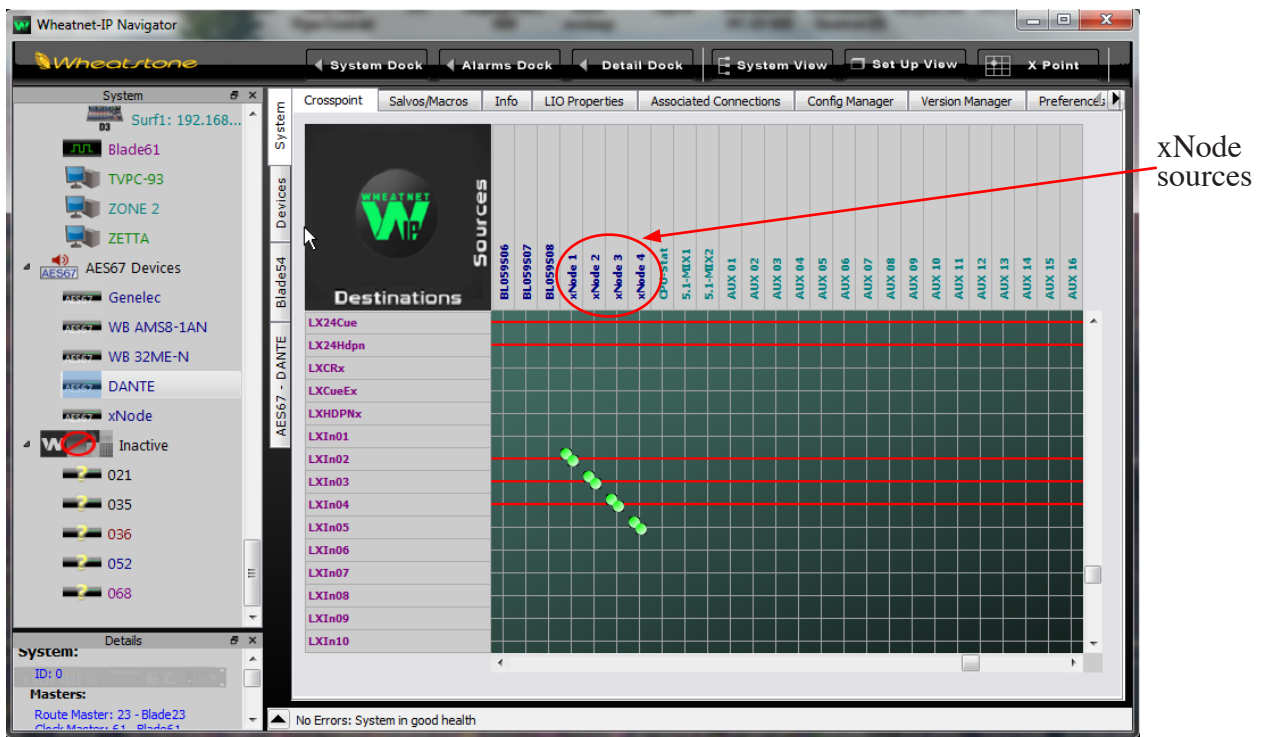

Example 2: Bringing in audio streams from an Axia xNode using 1ms packet timing

This process is exactly the same as the previous example with the added step of utilizing packet timing translation, to ingest the AES67 stream with 1ms packet timing and translate it to 1/4ms for use across the WNIP network.

For this example we'll simply edit one of the previously defined AES67 source streams to show the added step of packet translation. All of the steps to define the devices and streams are the same as in Example 1 with these changes:

- When defining the sources in the xNode, chose "Standard Stereo" as the stream mode; this is Axia's method of specifying 1ms packet timing.

Sources

#	Source Name:	Channel/Address:	Stream Mode:	Input Gain [dB]:
Line 1	SRC 1	239.192.240.100:50100	Low Latency Stereo	0.0
	AES67: Download stream description (SDP), RTSP: rtsp://192.168.87.86/by-id/1			
Line 2	SRC 2	239.192.240.101:50100	Low Latency Stereo	0.0
	AES67: Download stream description (SDP), RTSP: rtsp://192.168.87.86/by-id/2			
Line 3	SRC 3	239.192.240.102:5004	Standard Stereo	0.0
	AES67: Download stream description (SDP), RTSP: rtsp://192.168.87.86/by-id/3			
AES 4	SRC 4	239.192.240.103:5004	Low Latency Stereo	0.0
	AES67: Download stream description (SDP), RTSP: rtsp://192.168.87.86/by-id/4			
Mic	SRC 5		Disabled	0.0

Show source allocation status

Apply

Choose "Standard Stereo" to specify 1ms packet timing.

- On the WNIP side, in Navigator right-click on the desired xNode source in the crosspoint grid header and choose Modify--->Edit to open the source stream configuration window. Click on the AES67 1ms support check box; this will tell WNIP to utilize the translation function you activated earlier when you first set up to use AES67 devices (page 9 of this addendum) for this stream.

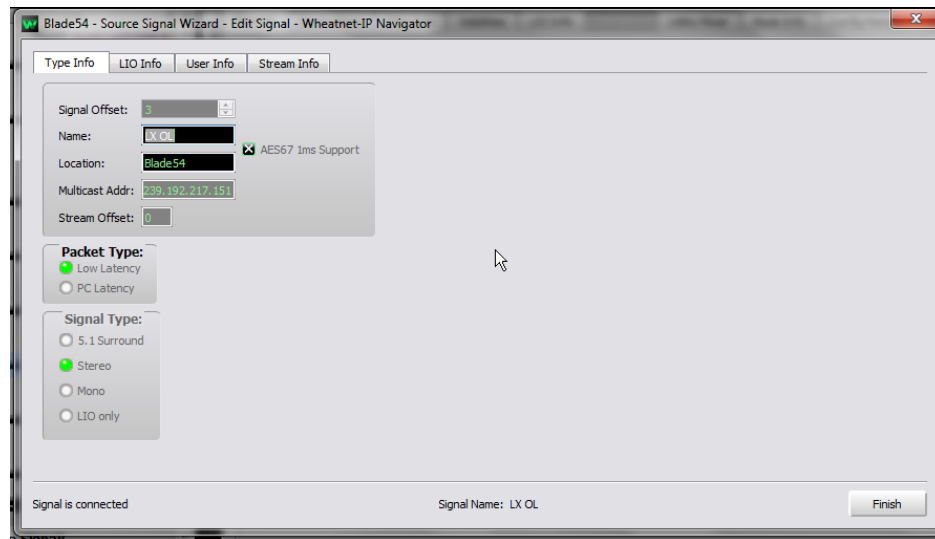

- Once you do this and click “Finish” WNIP creates a translated copy of the AES67 1ms stream and makes it available to all of the WNIP system destinations.

Translated 1/4ms stream

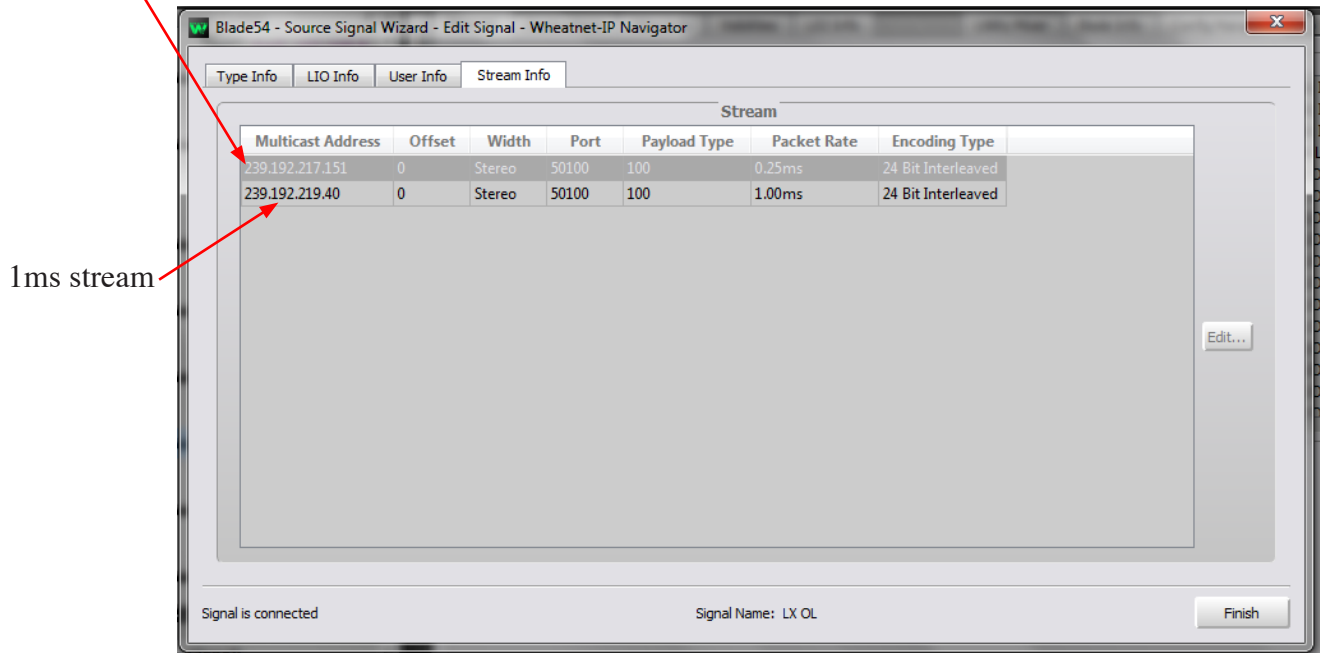

1ms stream

The Navigator crosspoint grid will work as normal, the AES67 device stream still appears as a source signal in the system and WNIP destinations will connect to it by clicking on the crosspoint just as you are used to. The intelligence built into WNIP will realize which packet timing your specific connection request will need and under-the-hood connect your destination to the appropriate stream, 1ms or 1/4ms, without the user having to specify it. The same is true with source controllers on Wheatstone consoles or other hardware controllers making it easy for users; the source name will appear to users and they can select it without having to know anything about packet timing and translation.

Source with 1/4ms packet timing

Source with 1ms packet timing

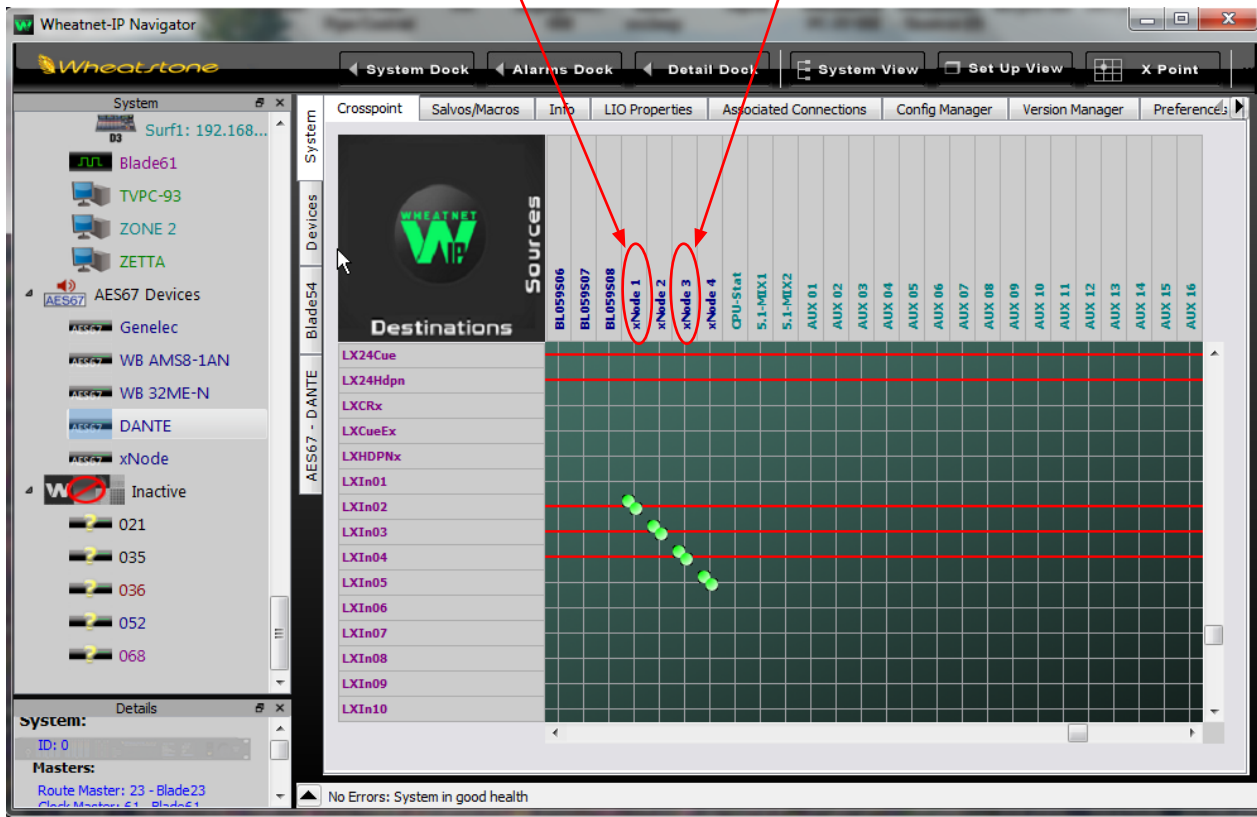

Example 3: Sending a WNIP audio stream to an Axia xNode using 1/4ms packet timing

In this example, the process is very similar to the first example, except that the devices are reversed: WNIP AES67 is the source device and xNode is the destination.

For 1/4ms packet timing the tasks are simplified because WNIP automatically creates streams for every WNIP source as soon as it enters the system. Again, the sources and their stream details are shown in the Navigator--->System View--->Source Streams window. All WNIP sources in the system will show in this window, and any time you add new WNIP devices their source streams will be added to the list automatically.

Sig Id	Name	Location	Index	Multicast Address	Offset	Width	Port	Payload Type	Packet Rate	Encoding Type	Clock Type	GMID
53.1.8.8	Spare09	Blade53	0	0.0.0.0	0	Stereo	50100	100	0.25ms	24 Bit Interleaved	Precision Time Protocol	00-50-c2-ff-fe-90-05-05
53.1.8.9	Spare10	Blade53	0	0.0.0.0	0	Stereo	50100	100	0.25ms	24 Bit Interleaved	Precision Time Protocol	00-50-c2-ff-fe-90-05-05
53.1.8.10	Spare11	Blade53	0	0.0.0.0	0	Stereo	50100	100	0.25ms	24 Bit Interleaved	Precision Time Protocol	00-50-c2-ff-fe-90-05-05
53.1.8.11	Spare12	Blade53	0	0.0.0.0	0	Stereo	50100	100	0.25ms	24 Bit Interleaved	Precision Time Protocol	00-50-c2-ff-fe-90-05-05
53.1.8.12	LXTIMER	Blade53	0	0.0.0.0	0	Stereo	50100	100	0.25ms	24 Bit Interleaved	Precision Time Protocol	00-50-c2-ff-fe-90-05-05
53.1.8.13	LXTALLY	Blade53	0	0.0.0.0	0	Stereo	50100	100	0.25ms	24 Bit Interleaved	Precision Time Protocol	00-50-c2-ff-fe-90-05-05
54.0.3.0	BLS4UMXA	Blade54	0	239.192.217.144	0	Stereo	50100	100	0.25ms	24 Bit Interleaved	Precision Time Protocol	00-50-c2-ff-fe-90-05-05
54.0.3.1	BLS4UMXB	Blade54	0	239.192.217.145	0	Stereo	50100	100	0.25ms	24 Bit Interleaved	Precision Time Protocol	00-50-c2-ff-fe-90-05-05
54.0.3.2	BLS4UMYA	Blade54	0	239.192.217.146	0	Stereo	50100	100	0.25ms	24 Bit Interleaved	Precision Time Protocol	00-50-c2-ff-fe-90-05-05
54.0.3.3	BLS4UMYB	Blade54	0	239.192.217.147	0	Stereo	50100	100	0.25ms	24 Bit Interleaved	Precision Time Protocol	00-50-c2-ff-fe-90-05-05
54.1.0.0	LX PGM	Blade54	0	239.192.217.148	0	Stereo	50100	100	0.25ms	24 Bit Interleaved	Precision Time Protocol	00-50-c2-ff-fe-90-05-05
54.1.0.1	LX AUD	Blade54	0	239.192.217.149	0	Stereo	50100	100	0.25ms	24 Bit Interleaved	Precision Time Protocol	00-50-c2-ff-fe-90-05-05
54.1.0.1	LX AUD	Blade54	1	239.192.219.36	0	Stereo	5004	100	1.00ms	24 Bit Interleaved	Precision Time Protocol	00-50-c2-ff-fe-90-05-05
54.1.0.2	LX AUX	Blade54	0	239.192.217.150	0	Stereo	50100	100	0.25ms	24 Bit Interleaved	Precision Time Protocol	00-50-c2-ff-fe-90-05-05
54.1.0.2	LX AUX	Blade54	1	239.192.219.38	0	Stereo	50100	100	1.00ms	24 Bit Interleaved	Precision Time Protocol	00-50-c2-ff-fe-90-05-05
54.1.0.3	LX OL	Blade54	0	239.192.217.151	0	Stereo	50100	100	0.25ms	24 Bit Interleaved	Precision Time Protocol	00-50-c2-ff-fe-90-05-05
54.1.0.3	LX OL	Blade54	1	239.192.219.40	0	Stereo	50100	100	1.00ms	24 Bit Interleaved	Precision Time Protocol	00-50-c2-ff-fe-90-05-05
54.1.2.0	LXAux1	Blade54	0	239.192.217.152	0	Stereo	50100	100	0.25ms	24 Bit Interleaved	Precision Time Protocol	00-50-c2-ff-fe-90-05-05
54.1.2.1	LXAux2	Blade54	0	239.192.217.153	0	Stereo	50100	100	0.25ms	24 Bit Interleaved	Precision Time Protocol	00-50-c2-ff-fe-90-05-05
54.1.2.2	LXAux3	Blade54	0	239.192.217.154	0	Stereo	50100	100	0.25ms	24 Bit Interleaved	Precision Time Protocol	00-50-c2-ff-fe-90-05-05
54.1.2.3	LXAux4	Blade54	0	239.192.217.155	0	Stereo	50100	100	0.25ms	24 Bit Interleaved	Precision Time Protocol	00-50-c2-ff-fe-90-05-05

So the first step in this example is to decide which stream(s) you want to send to the xNode and copy their multicast address(es).

Once you've identified the desired WNIP streams and copied their multicast addresses, open a browser window on the xNode device and choose the "Destinations" menu item.

In the xNode destinations window, enter the desired WNIP stream information for the destination.

Use the format multicast address:port number.

Once you've entered the information and hit "Apply", you can exit the browser session and you're ready to start streaming from WNIP to xNode. First though its important to have a clear understanding of the differences between sources and destinations in AoIP.

WNIP stream multicast address and port

Destinations

#	Name:	Channel/Address:	Type:	Gain [dB]:
Line 1	DST 1	239.192.217.148:50100	From source	0.0
Line 2	DST 2	239.192.219.36:5004	From source	0.0
Line 3	DST 3	239.192.219.38:50100	From source	0.0
AES 4	DST 4	239.192.219.40:50100	From source	0.0

A source is a physical audio device that makes its audio available to any and all other devices that want to receive it. In other words, a source is destination agnostic; it makes no difference as to which devices want to receive the audio. In fact a source has no knowledge of where its audio is going to go. It simply puts out its audio stream and the network switches are responsible for getting it to the desired receivers via multicast and IGMP. A source stream can go to one destination or one hundred and it makes no difference to the source.

A destination is a physical audio device that receives one and only one specific audio stream. A destination is not source agnostic in the sense that it cares very much what audio it is receiving and needs to be specifically told what stream to be listening to. That's what we just finished doing in the xNode. In the example above we told it to receive a stream with the multicast address of 239.192.217.148 on port 50100.

Because the AES67 standard provides no method of discovery and connection management there is no standardized method to control which stream a destination should be receiving; different vendors use different methods and without a standard there is no way to control this.

The fall out from this is that unlike AES67 sources, connections to all AES67 destinations cannot be managed from a crosspoint grid. Not with WNIP, Axia, Ravenna, Dante, or any other routing application. Destination stream connections must be managed from within the AES67 devices own configuration tools, as we did with the xNode destinations window in the example above.

While unfortunate, this is not too much of a problem for routes that are mostly static (like for instance a program feed to your on-air processor). But for routes that are frequently changing (remotes, codecs, and so far) this can be unmanageable. You have to open the destination device configuration tool and manually enter the desired source stream data every time you wanted to receive a different stream.

With a WNIP system there is a very handy work around for this problem. Here's how you do it.

When you are entering the source stream information into the AES67 device destination, don't use the actual desired source information. Instead chose an output from one of the many Utility Mixers in the WNIP system (there are four Utility mixes available in each Blade) and enter the stream information for the Utility Mixer into the AES67 destination device.

It sounds counter-intuitive; why tell a destination device to receive a stream different from the one you actually want?

Here's how it works. By having the AES67 device receive the Utility Mixer stream, you can then connect any system device to the Utility mixer inputs and your routing system is once again dynamic. You can change whatever you wish to send to the AES67 destination by clicking sources on the crosspoint grid anytime you want without having to type in new stream parameters. You can even mix sources together and turn them on and off remotely with this Utility mixer technique making it a very powerful way to control AES67 destination signal routing.

There's an additional benefit: by assigning various WNIP sources to the Utility Mixer channels and mapping that Utility Mixer to your AES67 device, you've in affect created an AES67 hot button controller. With sources assigned to the Utility Mixer channels you can quickly switch between them by turning the Utility Mixer channels On or Off by clicking on them, mapping them to LIO ports wired to switches, or using soft buttons or

scripts to trigger them. That's really handy for managing AES67 destinations.

One final note about AES67 destination routing. WNIP devices do not normally send out streams unless there is a destination requesting them. This is a deliberate feature that limits unnecessary network traffic and helps reduce the network switch requirements to keep switch expenses down. Since an AES67 device does not speak, "WNIP" control messages something must be done to cause the WNIP source stream to start if it is not in use by WNIP elsewhere in the system.

For AES67 1msec translated streams this is not an issue. Since you've "told" WNIP that you are creating an AES67 stream by activating translation, the stream will start (both the 1/4 msec and 1 msec versions) immediately, no need for any other actions.

But for standard WNIP 1/4 msec streams that you may want to use with 1/4 msec capable AES67 devices you must "tell" WNIP to start the stream.

There are a few ways to accomplish this:

- Route the desired WNIP source stream (in this case the Utility mixer output) to an additional WNIP destination that would be useful like a logger.
- Route the WNIP stream to a destination not necessarily useful, but not harmful. Something like an unused Blade destination, Blade front panel headphone jack destination, Windows driver channel, etc.
- Our favorite: Route the WNIP Utility Mixer source stream (the one you are sending to the AES67 device) to input 8 of that same Utility mixer. Since the Utility Mixer source is a WNIP device it will start streaming because of the connection request from the WNIP destination (Utility Mixer channel 8) and the stream will be available for the AES67 device. We like this approach because you're not likely to need that destination for anything else. You'll still have 7 channels of the Utility Mixer available for source selection and/or mixing. Just remember to keep that Utility Mixer channel 8 turned Off and potted down to avoid potential feedback.

Example 4: Sending a WNIP audio stream to an Axia xNode using 1ms packet timing.

In this case everything is the same as in Example 3, except once again we must make use of packet translation.

Rather than re-numerating everything from scratch, let's simply edit our settings from Example 3.

Since we'll be using 1ms packet timing in this example we need to use WNIP translation services.

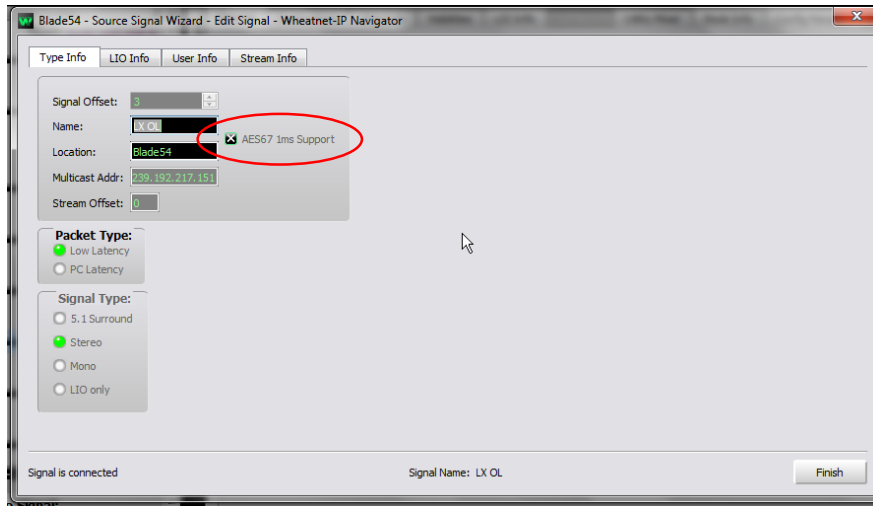

In Navigator, choose the desired source. If you've followed our suggestion in Example 3 the source will likely be a Utility Mixer output. Open the source detail window (either by right-clicking on the source name on the crosspoint grid or choosing Blade-->Sources--->Edit) and turn on "AES67 1ms support" for that source.

After you've checked the box and clicked "Finish" WNIP will create a translated copy of the source stream with 1ms packet timing.

Clicking on the "Stream Info" window will now show two streams for the source, the standard 1/4ms WNIP stream and the translated 1ms version.

Translated 1ms AES67 stream

Normal 1/4ms WNIP stream

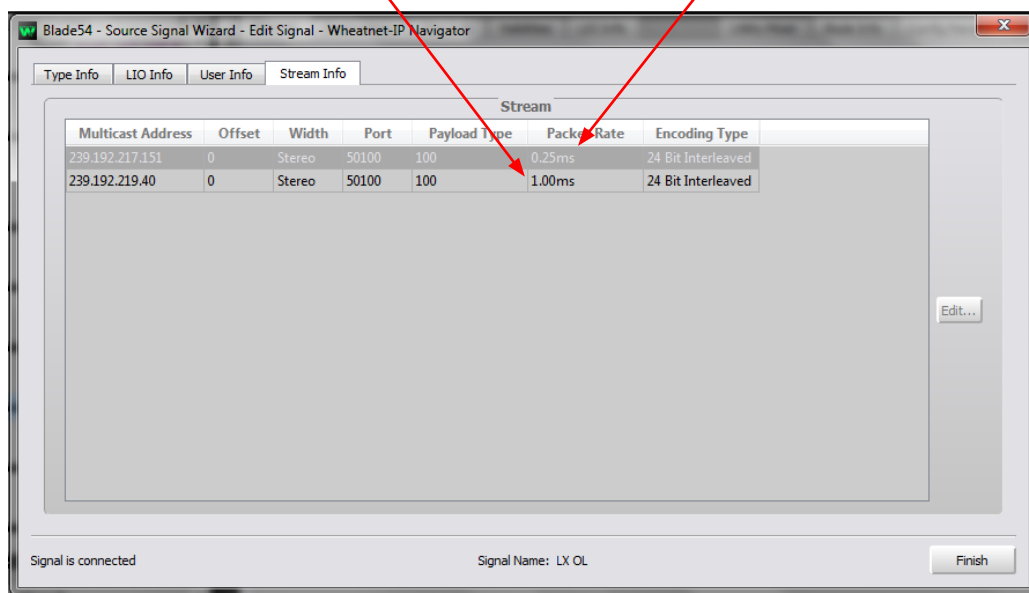

It's very important to notice that the translated 1ms stream has its own unique multicast address, auto-generated by WNIP. Make a note of this multicast address.

Also, you can click on this new stream and choose "Edit" if you need to change ports to the default AES67 5004. There's a practical reason to use 5004 as the port for AES67 streams even if your AES67 device does not require it. In the System View---->Source Streams window you can click on the "Port" column and the streams will be sorted by port#. This allows you to quickly see all of your AES67 streams in one place which can be handy in a system with hundreds of signals.

Set AES67 stream port, etc. here

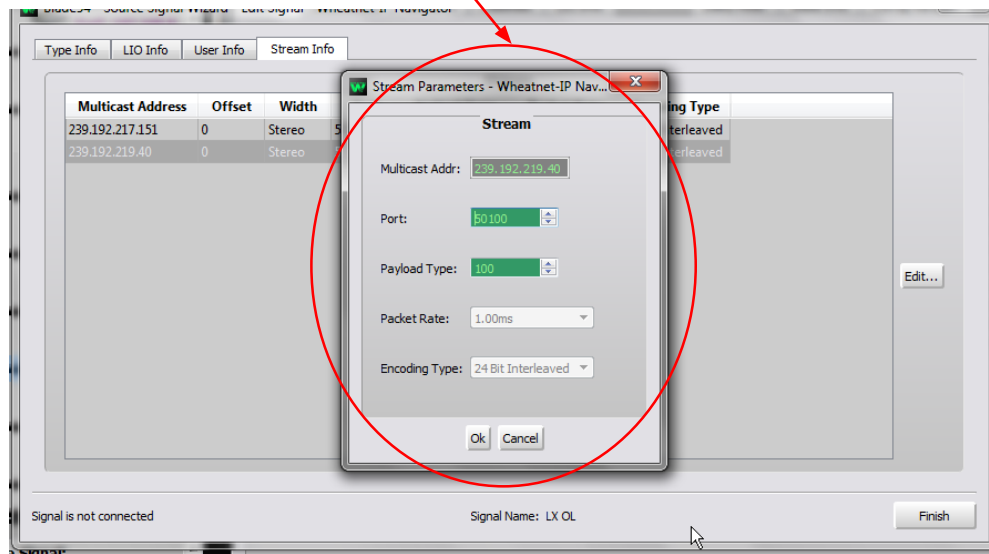

Once you have configured the AES67 1ms stream, you just need to open a browser window into the xNode and enter the multicast address for it into the xNode destinations window and you're all set as in Example 3. With devices that don't require 1ms packet timing we recommend that you stick to 1/4 ms for best latency performance; you'll need this translation technique only for devices like Dante that don't support it.

Enter 1ms address and port here

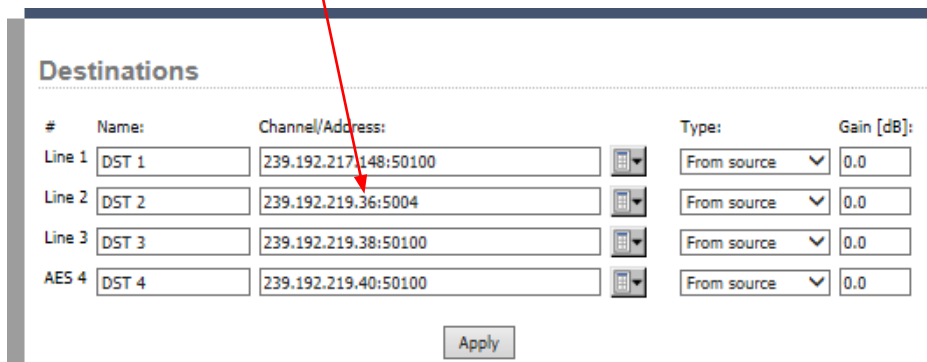

SDP Files

The AES67 standard provides a way for stream transmitters to encapsulate all of this multicast address/IP address/port/packet timing/format information about their AES67 streams in a standardized way; the so called SDP file.

Some AES67 devices will not let you manually mange streaming details as we have done in the previous examples. Although it is the same information, these type devices can only ingest it in the form of this SDP file.

WNIP provides a simple mechanism to create an SDP file for any desired WNIP stream for AES67 devices that require one.

To create an SDP file for a WNIP stream, right-click on the desired source stream's name on the Navigator crosspoint grid. This will open a window that will allow you to create the file.

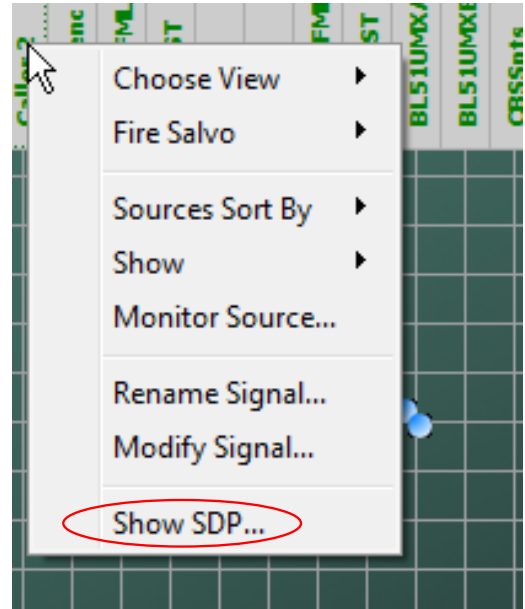

SAMPLE SDP file from WNIP

Stream multicast address

IP address

Port

Sample rate and stream format

Packet timing

PTP clock details

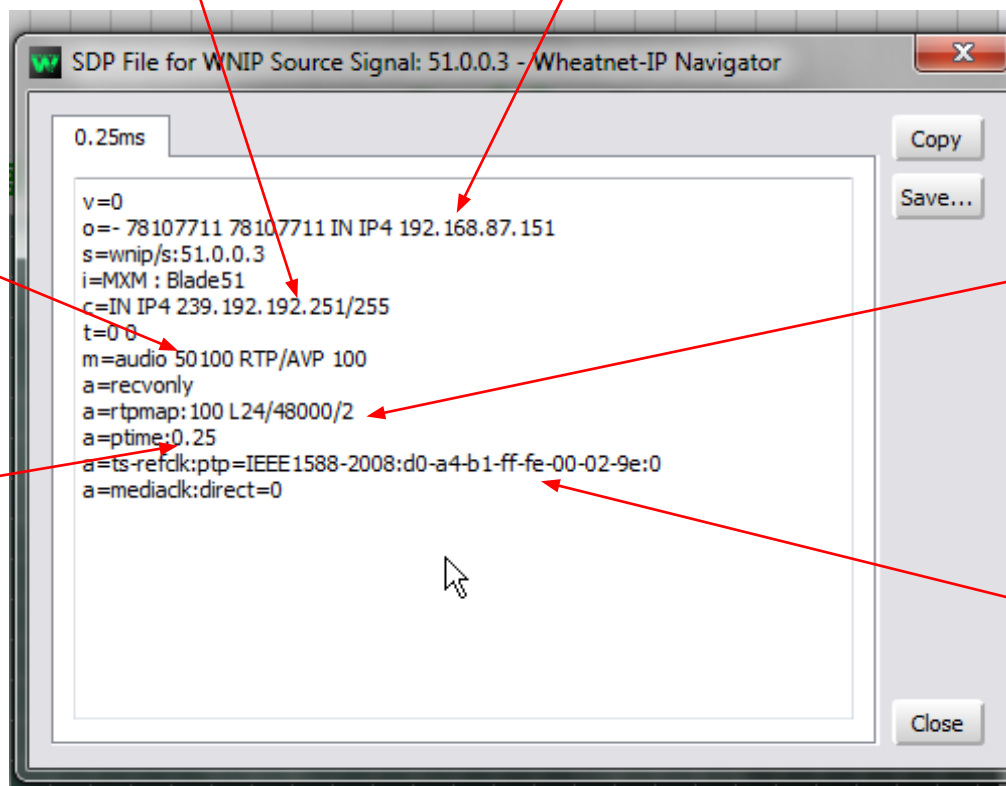

SAMPLE SDP file from Dante

Stream multicast address

IP address

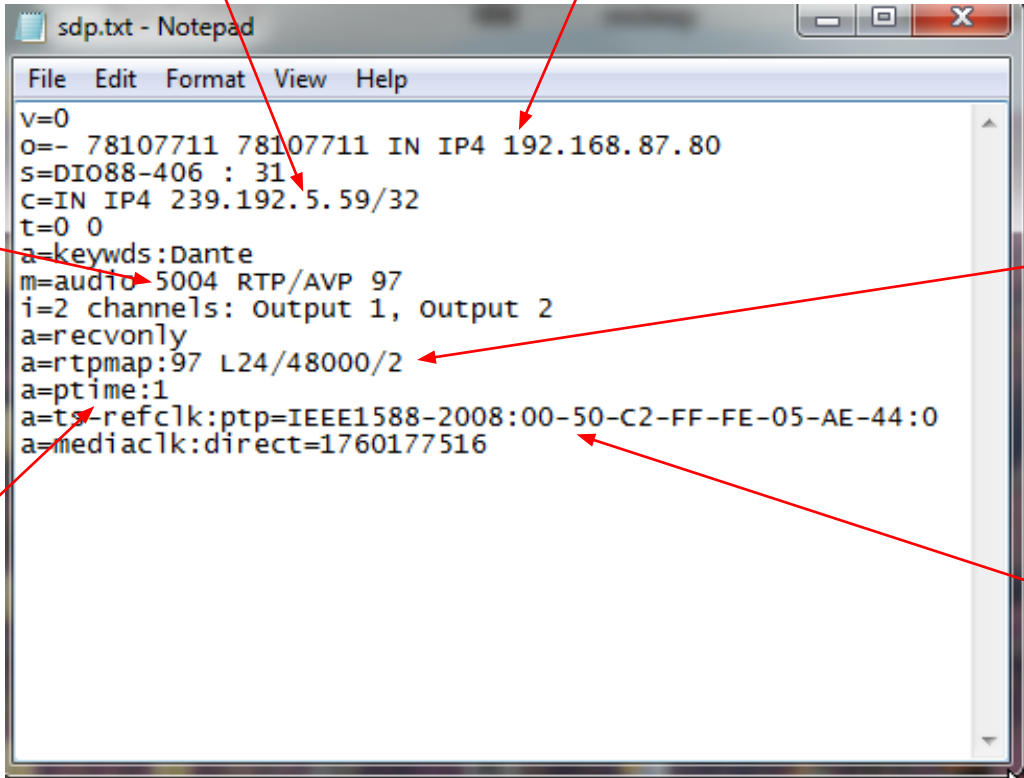

```
sdp.txt - Notepad
File Edit Format View Help
v=0
o=- 78107711 78107711 IN IP4 192.168.87.80
s=DIO88-406 : 31
c=IN IP4 239.192.5.59/32
t=0 0
a=keywds:Dante
m=audio 5004 RTP/AVP 97
i=2 channels: output 1, output 2
a=recvonly
a=rtpmap:97 L24/48000/2
a=ptime:1
a=tsr-refclk:ptp=IEEE1588-2008:00-50-C2-FF-FE-05-AE-44:0
a=mediaclk:direct=1760177516
```

Port

Sample rate and stream format

Packet timing

PTP clock details

Summary

In this Addendum we've shown how to inter-operate AES67 devices with a WNIP system. While the process is somewhat cumbersome due to the nature of the AES67 standard and its lack of stream discovery and connection management specs, it is practical and it works.

Once you've set it up its very reliable and if you do so wisely and use our suggestion for destination source control via Utility Mixer, your set-up efforts will only be needed once.

Our examples here are for a specific AES67 device (Axia xNode) but the techniques are universal and will work with any AES67 device as far as the WNIP side is concerned. Each vendor has their own way of configuring their own devices and you will need to understand and use them as far as the individual devices are concerned. The methods vendors use are quite varied and may take a bit of studying to understand but the principles are the same:

- Provide a PTPv2 master clock source by using a Master Clock.
- Assure all devices are on the same IP subnet as multicasting does not normally cross subnet boundaries.
- Configure the desired multicast addresses, port, packet timing, and payload type for Source streams.
- Configure Destinations with the stream details for the desired stream to receive.

In the examples we've shown, we used devices (WNIP and xNode) that allow direct editing of stream details/parameters so as to provide a clear sense of what is happening under the hood. Not all AES67 device vendors allow such direct editing, but the principles are the same. Some vendors depend on the reception of an SDP file for each stream. Some even require the stream details to be "announced" in their specific stream discovery protocol. This is an unfortunate consequence of the incomplete nature of the AES67 standard and one we have to live with if we want to inter-operate with AES67 based devices.

You'll need to know exactly how the device you want to use with your WNIP system is meant to be configured in order to be successful. Obviously we have not interfaced with every single AES67 compatible device out there, but we have worked with a good number of them in our shop and at various AES sponsored Interop workshops. We've successfully inter-operated with all of them and you will too.

That's not to say that there aren't any problem with AES67. Beyond the stream discovery and connection management issues already discussed there are still a number of shortcomings.

WNIP has been designed to be a dynamic AoIP system, not just an I/O device. All WNIP devices communicate lots of system level information on the network. Change a source name in Navigator and every WNIP device in the system instantly updates the source name it will show the user. Want to change the gain of the mic preamp in a Blade somewhere? Turn the gain knob on your console. Want some logic control function to be mated to an audio signal (say like Machine Start) and have the function follow wherever the audio is routed? WNIP does that. How about a crosspoint grid that lets you manage every connection in the system, with connection dots that turn red if the audio level gets too hot? Or a Salvo that can change dozens of connections at once with the click of one button. Silence detection and automatic switch over is another WNIP feature as is audio processing on any signal in the system.

Add an AES67 device to your WNIP system and it won't do any of that. But the AES67 compatibility we've built into WNIP and described above means that you can add any AES67 compatible device to your system and be confident you can stream audio to/from it.

Here's to success inter-operating with AES67.

Some Screen Shots of Various Vendors Configuration Screens

